

STUDENT MATHEMATICAL LIBRARY
Volume 15

Plane Algebraic Curves

Gerd Fischer



AMS
AMERICAN MATHEMATICAL SOCIETY

Selected Titles in This Series

- 15 **Gerd Fischer**, Plane algebraic curves, 2001
- 14 **V. A. Vassiliev**, Introduction to topology, 2001
- 13 **Frederick J. Almgren, Jr.**, Plateau's problem: An invitation to varifold geometry, 2001
- 12 **W. J. Kaczor and M. T. Nowak**, Problems in mathematical analysis II: Continuity and differentiation, 2001
- 11 **Michael Mesterton-Gibbons**, An introduction to game-theoretic modelling, 2000
- 10 **John Oprea**, The mathematics of soap films: Explorations with Maple[®], 2000
- 9 **David E. Blair**, Inversion theory and conformal mapping, 2000
- 8 **Edward B. Burger**, Exploring the number jungle: A journey into diophantine analysis, 2000
- 7 **Judy L. Walker**, Codes and curves, 2000
- 6 **Gérald Tenenbaum and Michel Mendès France**, The prime numbers and their distribution, 2000
- 5 **Alexander Mehlmann**, The game's afoot! Game theory in myth and paradox, 2000
- 4 **W. J. Kaczor and M. T. Nowak**, Problems in mathematical analysis I: Real numbers, sequences and series, 2000
- 3 **Roger Knobel**, An introduction to the mathematical theory of waves, 2000
- 2 **Gregory F. Lawler and Lester N. Coyle**, Lectures on contemporary probability, 1999
- 1 **Charles Radin**, Miles of tiles, 1999

Compliments of the
American Mathematical Society

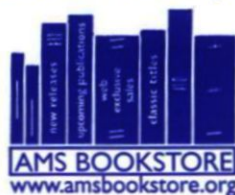

STUDENT MATHEMATICAL LIBRARY
Volume 15

Plane Algebraic Curves

Gerd Fischer

Translated by
Leslie Kay



AMS
AMERICAN MATHEMATICAL SOCIETY

Editorial Board

David Bressoud
Robert Devaney, Chair

Carl Pomerance
Hung-Hsi Wu

Originally published in German by Friedr. Vieweg & Sohn Verlagsgesellschaft mbH, D-65189 Wiesbaden, Germany, under the title "Ebene algebraische Kurven". 1. Auflage (1st edition) by Gerd Fischer.
© by Friedr. Vieweg & Sohn Verlagsgesellschaft mbH, Braunschweig, Wiesbaden, 1994.

2000 *Mathematics Subject Classification*. Primary 14H50, 14Hxx, 14-01.

Library of Congress Cataloging-in-Publication Data

Fischer, Gerd, 1939-

[Ebene algebraische Kurven. English]

Plane algebraic curves / Gerd Fischer ; translated by Leslie Kay.

p. cm. — (Student mathematical library, ISSN 1520-9121 ; v. 15)

Includes bibliographical references and index.

ISBN 0-8218-2122-9 (acid-free paper)

1. Curves, Algebraic. I. Title. II. Series.

QA567 .F5713 2001
516.3'52—dc21

2001031597

Copying and reprinting. Individual readers of this publication, and nonprofit libraries acting for them, are permitted to make fair use of the material, such as to copy a chapter for use in teaching or research. Permission is granted to quote brief passages from this publication in reviews, provided the customary acknowledgment of the source is given.

Republication, systematic copying, or multiple reproduction of any material in this publication is permitted only under license from the American Mathematical Society. Requests for such permission should be addressed to the Acquisitions Department, American Mathematical Society, 201 Charles Street, Providence, Rhode Island 02904-2294, USA. Requests can also be made by e-mail to reprint-permission@ams.org.

© 2001 by the American Mathematical Society. All rights reserved.

Reprinted by the American Mathematical Society, 2009.

The American Mathematical Society retains all rights except those granted to the United States Government.

Printed in the United States of America.

⊗ The paper used in this book is acid-free and falls within the guidelines established to ensure permanence and durability.

Visit the AMS home page at <http://www.ams.org/>

10 9 8 7 6 5 4 3 2 14 13 12 11 10 09

Contents

Preface to the English Edition	xi
Preface to the German Edition	xiii
Chapter 0. Introduction	1
0.1. Lines	1
0.2. Circles	2
0.3. The Cuspidal Cubic	3
0.4. The Nodal Cubic	4
0.5. The Folium of Descartes	6
0.6. Cycloids	7
0.7. Klein Quartics	9
0.8. Continuous Curves	10
Chapter 1. Affine Algebraic Curves and Their Equations	13
1.1. The Variety of an Equation	13
1.2. Affine Algebraic Curves	14
1.3. Study's Lemma	15

1.4. Decomposition into Components	17
1.5. Irreducibility and Connectedness	18
1.6. The Minimal Polynomial	18
1.7. The Degree	19
1.8. Points of Intersection with a Line	20
Chapter 2. The Projective Closure	23
2.1. Points at Infinity	23
2.2. The Projective Plane	23
2.3. The Projective Closure of a Curve	25
2.4. Decomposition into Components	27
2.5. Intersection Multiplicity of Curves and Lines	28
2.6. Intersection of Two Curves	29
2.7. Bézout's Theorem	31
Chapter 3. Tangents and Singularities	35
3.1. Smooth Points	35
3.2. The Singular Locus	36
3.3. Local Order	37
3.4. Tangents at Singular Points	40
3.5. Order and Intersection Multiplicity	44
3.6. Euler's Formula	45
3.7. Curves through Prescribed Points	47
3.8. Number of Singularities	49
3.9. Chebyshev Curves	50
Chapter 4. Polars and Hessian Curves	59
4.1. Polars	59

Contents	vii
4.2. Properties of Polars	64
4.3. Intersection of a Curve with Its Polars	64
4.4. Hessian Curves	65
4.5. Intersection of the Curve with Its Hessian Curve	67
4.6. Examples	69
Chapter 5. The Dual Curve and the Plücker Formulas	73
5.1. The Dual Curve	73
5.2. Algebraicity of the Dual Curve	80
5.3. Irreducibility of the Dual Curve	81
5.4. Local Numerical Invariants	83
5.5. The Bidual Curve	85
5.6. Simple Double Points and Cusps	86
5.7. The Plücker Formulas	88
5.8. Examples	90
5.9. Proof of the Plücker Formulas	90
Chapter 6. The Ring of Convergent Power Series	95
6.1. Global and Local Irreducibility	95
6.2. Formal Power Series	96
6.3. Convergent Power Series	99
6.4. Banach Algebras	100
6.5. Substitution of Power Series	103
6.6. Distinguished Variables	105
6.7. The Weierstrass Preparation Theorem	107
6.8. Proofs	109
6.9. The Implicit Function Theorem	114

6.10.	Hensel's Lemma	116
6.11.	Divisibility in the Ring of Power Series	117
6.12.	Germ of Analytic Sets	120
6.13.	Study's Lemma	121
6.14.	Local Branches	122
Chapter 7. Parametrizing the Branches of a Curve by Puiseux Series		125
7.1.	Formulating the Problem	125
7.2.	Theorem on the Puiseux Series	126
7.3.	The Carrier of a Power Series	127
7.4.	The Quasihomogeneous Initial Polynomial	129
7.5.	The Iteration Step	131
7.6.	The Iteration	132
7.7.	Formal Parametrizations	135
7.8.	Puiseux's Theorem (Geometric Version)	136
7.9.	Proof	138
7.10.	Variation of Solutions	141
7.11.	Convergence of the Puiseux Series	142
7.12.	Linear Factorization of Weierstrass Polynomials	144
Chapter 8. Tangents and Intersection Multiplicities of Germs of Curves		147
8.1.	Tangents to Germs of Curves	147
8.2.	Tangents at Smooth and Singular Points	149
8.3.	Local Intersection Multiplicity with a Line	150
8.4.	Local Intersection Multiplicity with an Irreducible Germ	155

8.5. Local Intersection Multiplicity of Germs of Curves	157
8.6. Intersection Multiplicity and Order	158
8.7. Local and Global Intersection Multiplicity	159
Chapter 9. The Riemann Surface of an Algebraic Curve	163
9.1. Riemann Surfaces	163
9.2. Examples	165
9.3. Desingularization of an Algebraic Curve	168
9.4. Proof	170
9.5. Connectedness of a Curve	175
9.6. The Riemann-Hurwitz Formula	175
9.7. The Genus Formula for Smooth Curves	176
9.8. The Genus Formula for Plücker Curves	178
9.9. Max Noether's Genus Formula	180
Appendix 1. The Resultant	181
A.1.1. The Resultant and Common Zeros	181
A.1.2. The Discriminant	183
A.1.3. The Resultant of Homogeneous Polynomials	184
A.1.4. The Resultant and Linear Factors	185
Appendix 2. Covering Maps	189
A.2.1. Definitions	189
A.2.2. Proper Maps	191
A.2.3. Lifting Paths	192
Appendix 3. The Implicit Function Theorem	193
Appendix 4. The Newton Polygon	197
A.4.1. The Newton Polygon of a Power Series	197

A.4.2. The Newton Polygon of a Weierstrass Polynomial	199
Appendix 5. A Numerical Invariant of Singularities of Curves	205
A.5.1. Analytic Equivalence of Singularities	205
A.5.2. The Degree of a Singularity	206
A.5.3. The General Class Formula	210
A.5.4. The General Genus Formula	211
A.5.5. Degree and Order	212
A.5.6. Examples	214
Appendix 6. Harnack's Inequality	217
A.6.1. Real Algebraic Curves	217
A.6.2. Connected Components and Degree	218
A.6.3. Homology with Coefficients in $\mathbb{Z}/2\mathbb{Z}$	221
Bibliography	223
Subject Index	227
List of Symbols	231

Preface to the English Edition

I am very pleased that the AMS has decided to publish an English version of the German text. This was a good opportunity to add a new section (3.9) on the recently discovered Chebyshev curves and to improve the appendix on the implicit function theorem. My thanks go to the AMS and Vieweg for this joint project, to Leslie Kay for her excellent translation, including many clarifications of details, and to my students in Düsseldorf (especially Nadine Engeler, Thorsten Haarhoff, and Thorsten Warmt) for their help in preparing the new sections.

München, January 2001

Gerd Fischer

Preface to the German Edition

How many zeros does a polynomial in one variable have? This question is answered definitively by the “fundamental theorem of algebra.” But if we go to two variables, the zero sets become infinite in general. These sets can be viewed as geometric objects—more precisely, as plane algebraic curves. So two paths intersect here, one from algebra and one from geometry, and it is hardly surprising that properties of such curves have been pondered for many centuries.

Adding yet another book to the countless books on this topic demands justification, or at least an explanation of some special point of view. I won’t conceal the external stimulus: Several years ago, I was encouraged to write something about algebraic curves. My immediate response was that there were already a lot of books—perhaps too many books—about them. But I couldn’t resist the temptation to keep giving lectures on the subject and writing up my notes. Let me briefly explain what they eventually turned into.

The text consists of two very different parts. In Chapters 0 to 5, the geometry of curves is explained in as elementary a way as possible: tangents, singularities, inflection points, etc. The most important technical tool is the intersection multiplicity, which is based on the resultant, and the main result is Bézout’s theorem on the number

of points of intersection of two curves. This part culminates in the Plücker formulas, in Chapter 5. These formulas relate the invariants studied in the preceding chapters.

The Plücker formulas can be given an almost—but not completely—precise proof by elementary techniques. What is missing, in particular, is a deeper understanding of duality and an efficient way to compute the intersection multiplicities that appear. The necessary local and global techniques from analysis are given later, in Chapters 6 to 9. Although the results are relatively easy to state and apply, laying a sound foundation takes some work.

Chapters 6 to 8 therefore contain an introduction to local complex analysis. This is the theory of either convergent power series or holomorphic functions of several variables, depending on one's preferred point of view. Here power series and the algebraic properties of rings of power series are emphasized; this approach goes back to the pioneering work of Rückert [R].

In the last chapter, the local parametrizations are patched together into a Riemann surface. Borrowing from a famous quotation of Felix Klein, one might say that curves are then regarded as freed from their cage—the projective plane—and floating outside a fixed space. The genus formula is ultimately an extension of the elementary Plücker formulas.

The appendices contain some technical tools from algebra and topology that are used repeatedly, as well as supplements to the preceding chapters.

Throughout the text an attempt was made to stay very concrete and, when possible, to give procedures for computing something by using polynomials and power series. The many examples and figures should also help keep things concrete. This aspect of algebraic geometry, long regarded as rather old-fashioned, has regained importance.

As one might expect, almost everything here can be found in a similar form elsewhere. I would especially like to mention Walker [Wa], Burau [Bu], and Brieskorn-Knörrer [B-K]. My goal was as concise a text as possible for an introductory one- or two-semester course. (Following a remark of Horst Knörrer, one could describe this little

book as a portable version of the stationary model [B-K].) All that is assumed is some basic background, especially in elementary algebra and complex function theory. A great deal of effort has only strengthened my conviction that there hardly exists a more beautiful approach to algebraic geometry and complex analysis than through algebraic curves. Geometric intuition and “analytic” methods still lie very close together here, and every new technique is completely motivated by clear geometric problems—as in paradise before the many falls from grace.

My thanks go to all who helped bring this book into being: my teacher R. Remmert for his encouragement; my students at Düsseldorf and UC Davis for their suggestions for improvements; Mr. H.-J. Stoppel for his untiring help in countless details and the production of the \TeX manuscript; Mr. U. Daub for plotting the first pictures; Mr. C. Töller for the final production of the finished figures; and finally Vieweg, the publishers, who expressed their willingness to publish the book in the German language and at a student-friendly price.

Düsseldorf, June 1994

Gerd Fischer

Chapter 0

Introduction

Let an object move through space as time passes. The task of curve theory is to describe this process abstractly and study it in detail. Modern curve theory has many branches, and no attempt will be made here to give an overview of the numerous questions that are treated in this context. Instead we will carefully examine a small, clearly delimited, but very exciting part: the elementary theory of *plane algebraic curves*. The first restriction, *plane*, means that the space in which the motion occurs is only *two-dimensional*; this makes a number of things easier. Before explaining what we mean by an *algebraic curve*, we give a few examples of general plane curves.

The moving object is assumed to be a point. Then its motion in the plane is described by a map

$$\varphi : I \rightarrow \mathbb{R}^2, \quad t \mapsto \varphi(t) = (x_1(t), x_2(t)),$$

where $I \subset \mathbb{R}$ denotes an interval. The *parameter* t can be viewed as *time*.

0.1. A *line* can be described by

$$\varphi(t) = v + tw,$$

where $v, w \in \mathbb{R}^2$ are vectors and the direction vector w is not the zero vector. Here we may take I to be \mathbb{R} . The same subset $C = \varphi(\mathbb{R}) \subset \mathbb{R}^2$ can be traced in many different ways; that is, there are many different

parametrizations φ with the same trace $\varphi(I)$ —just as the railroad, with a fixed network of tracks, can keep setting up new timetables. It will turn out that there is far less freedom of choice in the equations f that describe C ; that is,

$$C = \{(x_1, x_2) \in \mathbb{R}^2 : f(x_1, x_2) = 0\}.$$

In the case of a line, we always have a linear equation

$$f(x_1, x_2) = a_1x_1 + a_2x_2 + b, \quad \text{with } (a_1, a_2) \neq (0, 0),$$

but every $g = c \cdot f^k$ with $c \in \mathbb{R}^*$ and $k \in \mathbb{N}^*$ obviously describes the same line. In Section 1.6 we will study carefully what other equations there can be.

0.2. The circle C with center (z_1, z_2) and radius r has an equation

$$(x_1 - z_1)^2 + (x_2 - z_2)^2 = r^2$$

and a transcendental parametrization

$$\varphi(t) = (z_1 + r \cos t, z_2 + r \sin t).$$

There is also a *rational parametrization*, which we construct for the case $(z_1, z_2) = (0, 0)$ and $r = 1$. To do this, we project the circle from the point $p = (0, 1)$ onto the line $x_2 = 0$. It is easy to check that under this projection the point

$$(\varphi_1(t), \varphi_2(t)) = \left(\frac{2t}{t^2 + 1}, \frac{t^2 - 1}{t^2 + 1} \right)$$

is mapped to $(t, 0)$. This results in the parametrization

$$\varphi : \mathbb{R} \rightarrow C \setminus \{p\} \subset \mathbb{R}^2, \quad t \mapsto (\varphi_1(t), \varphi_2(t))$$

of the punctured circle; see Figure 0.1. If we adjoin an infinitely distant point, or “point at infinity,” ∞ to \mathbb{R} , it makes sense to extend φ by setting $\varphi(\infty) = p$. In Chapter 2 we discuss how crucial such points at infinity are.

Rational parametrizations of arbitrary conic sections (ellipses, hyperbolas, parabolas) can be obtained in exactly the same way.

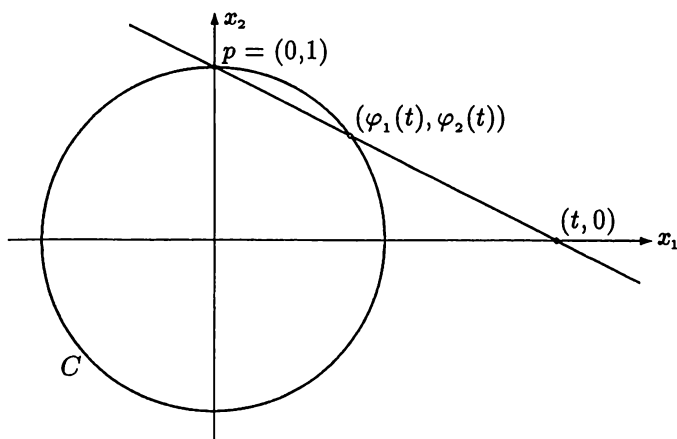

Figure 0.1. Rational parametrization of the circle

0.3. The *cuspidal cubic* (or *Neil's parabola*) $C \subset \mathbb{R}^2$ is given by the parametrization

$$\varphi(t) = (t^2, t^3)$$

and has the equation

$$x_1^3 - x_2^2 = 0.$$

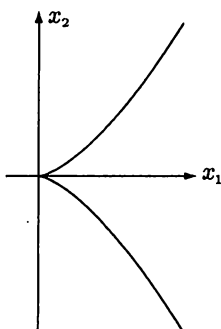

Figure 0.2. Cuspidal cubic

This is a polynomial of degree three, so the curve is called a *cubic*. The tangent vector is given by

$$\dot{\varphi}(t) = (2t, 3t^2), \quad \text{so} \quad \dot{\varphi}(0) = (0, 0).$$

At time $t = 0$ the velocity with which C is traced reverses direction, and its magnitude is zero. It can be shown that $\dot{\psi}(0) = (0, 0)$ for any differentiable parametrization

$$\psi : \mathbb{R} \rightarrow C \subset \mathbb{R}^2 \quad \text{with} \quad \psi(0) = (0, 0).$$

For sufficiently differentiable ψ_i , this follows easily from $\psi_1^3 = \psi_2^2$. It takes more work if ψ can be differentiated only once. This phenomenon can occur only at a *singular point*; the cusp of the cuspidal cubic is the simplest and most important example of a *singularity*.

0.4. Newton's *nodal cubic* is given by

$$C = \{(x_1, x_2) \in \mathbb{R}^2 : x_2^2 = x_1^2(x_1 + 1)\}.$$

To obtain a picture of the curve, it is useful to determine the points of intersection of C with the lines $x_1 = \lambda$. For $\lambda < -1$ there are none, for $\lambda = -1$ and $\lambda = 0$ there is one, and for all other λ there are two, with the square roots of $\lambda^3 + \lambda^2$ as abscissas.

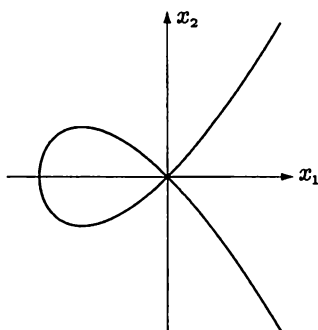

Figure 0.3. Nodal cubic

A rational parametrization

$$\varphi : \mathbb{R} \rightarrow C, \quad t \mapsto (t^2 - 1, t - t^3)$$

can be obtained by projecting the curve from the origin to the line $x_1 = -1$. Under this projection $\varphi(1) = \varphi(-1) = (0, 0)$. The origin is an *ordinary double point*; around it the curve has two *branches*, which correspond to the distinct values ± 1 of the parameter t .

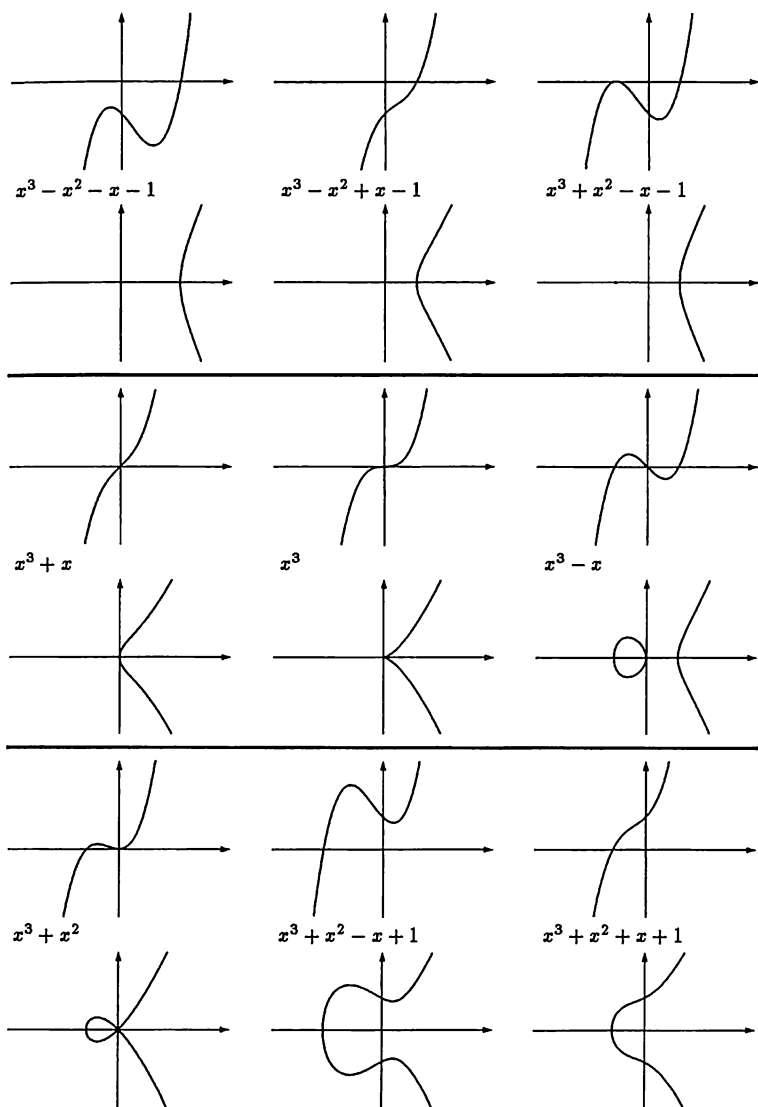

Figure 0.4. Newton's diverging parabolas: The curves $y = g(x)$ and $y^2 = g(x)$

In Newton's classification of cubic curves [Ne], as it was published in 1710, both the nodal cubic and the cuspidal cubic belong to the family of "diverging parabolas." These are defined in general by an equation of the form $x_2^2 = g(x_1)$, where g is a cubic polynomial. Some examples of curves $x_2 = g(x_1)$ and $x_2^2 = g(x_1)$ can be seen in Figure 0.4. There $x = x_1$ and $y = x_2$.

0.5. The *folium of Descartes* (named after R. Descartes) looks similar to the nodal cubic but, according to Newton, belongs to the family of "defective hyperbolas." The usual equation is

$$x_1^3 + x_2^3 - 3x_1x_2 = 0.$$

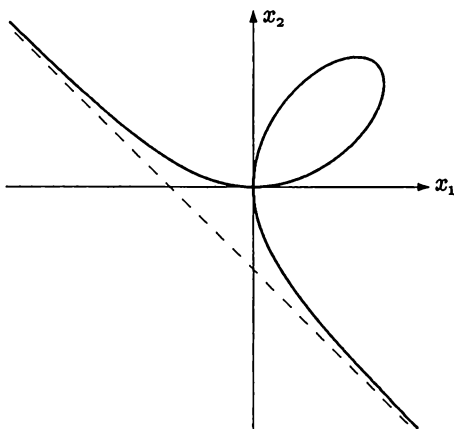

Figure 0.5. Folium of Descartes

The essential difference between this and the nodal cubic is the existence of an asymptote, which has the equation

$$x_1 + x_2 + 1 = 0.$$

If we rotate so that the axis of symmetry becomes $x_2 = 0$, then shift the asymptote to $x_1 = 0$, the folium of Descartes has an equation of the form

$$x_1x_2^2 = g(x_1),$$

where g is a cubic polynomial. According to Newton, this is characteristic of the defective hyperbolas. Newton's list of cubics contains

72 “species.” Later it was completed and, by switching to a coarser equivalence relation (complex projective instead of real affine—see Chapter 2), considerably simplified. Once this switch is made, the equation of any smooth cubic can be brought into Hesse normal form, which contains one complex parameter (see [B-K]).

The passage from quadrics to cubics already indicates that as the degrees of the equations increase, the classification problem becomes more and more difficult, and soon becomes hopeless. From degree 4 on, the list of examples can only be sporadic.

0.6. The path traced by the valve on a bicycle tire is an example of a *cycloid*. It can be parametrized by

$$x_1 = t - \sin t, \quad x_2 = 1 - \cos t.$$

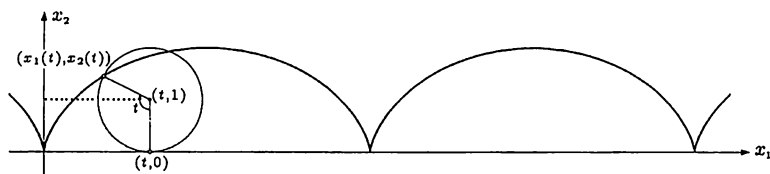

Figure 0.6. Cycloid

Since it meets the line $x_2 = 0$ in infinitely many points, it cannot be described by a polynomial (see Section 1.7). If a circle of radius r is permitted to roll along the inside of a circle of radius $R > r$, the path traced by a point on the inner circle is called a *hypocycloid*. It is closed when r/R is rational. If, say, $R = 1$ and $r = 1/3$, then the center of the small circle has coordinates $z = \frac{2}{3}(\cos t, \sin t)$ and the moving point is

$$p = (x_1, x_2) = z + \frac{1}{3}(\cos 2t, -\sin 2t) = \frac{1}{3}(2 \cos t + \cos 2t, 2 \sin t - \sin 2t).$$

Applying a few trigonometric identities gives

$$3(x_1^2 + x_2^2)^2 + 8x_1(3x_2^2 - x_1^2) + 6(x_1^2 + x_2^2) = 1$$

as the equation of the *hypocycloid of three cusps*. This polynomial has degree four, so it is called a *quartic*.

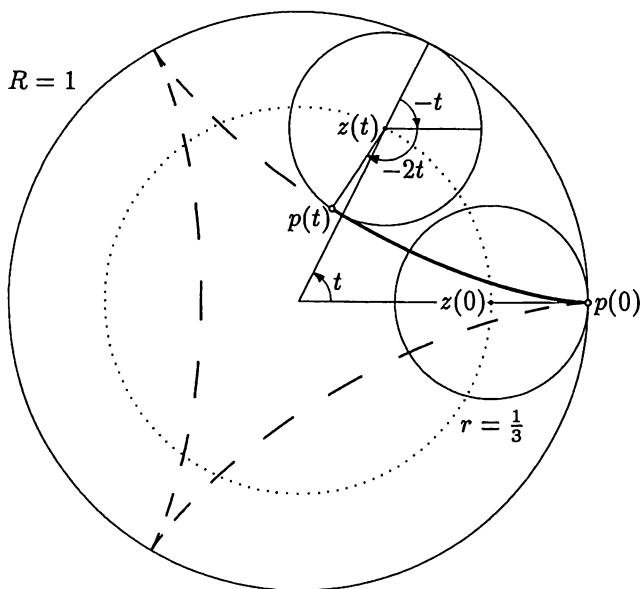

Figure 0.7. Constructing the hypocycloid of three cusps

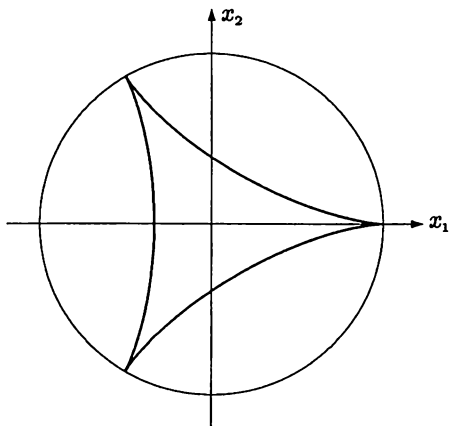

Figure 0.8. Hypocycloid of three cusps

A rational parametrization can be obtained by setting $\tau = \tan(t/2)$. Then

$$(\cos t, \sin t) = \left(\frac{1 - \tau^2}{1 + \tau^2}, \frac{2\tau}{1 + \tau^2} \right)$$

(see Section 0.2). Hence

$$p = (x_1, x_2) = \frac{1}{3(1 + \tau^2)^2} (3 - 6\tau^2 - \tau^4, 8\tau^3).$$

When $t = \pi$, we have $p = (-1/3, 0)$; the corresponding parameter is $\tan(t/2) = \infty$.

Example (d) of Section 5.1 gives a more elegant way of using the relationship between the circle and the hypocycloid.

If the ratio of the radii is irrational, then the cusps of the hypocycloid are dense in the outer circle. This is an immediate consequence of the following theorem.

Kronecker's Theorem. *Let $\alpha \in \mathbb{R}$ be irrational, and let $\xi \in \mathbb{R}$ be arbitrary. Then for every $\varepsilon > 0$ there exist integers n and p such that*

$$|n\alpha - \xi - p| < \varepsilon.$$

In short: the multiples $n \cdot \alpha$ are dense mod 1 (see [Cha], VIII).

0.7. Felix Klein constructed an interesting family of quartics as follows: Start with two ellipses C_1, C_2 , with equations

$$f_1 = x_1^2 + \frac{1}{4}x_2^2 - 1 = 0,$$

$$f_2 = \frac{1}{4}x_1^2 + x_2^2 - 1 = 0.$$

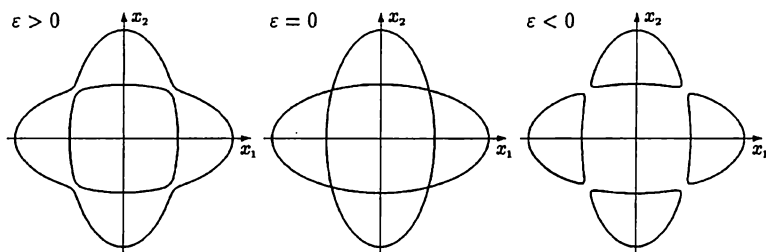

Figure 0.9. Three members of Felix Klein's family of quartics

The equation $f_1 \cdot f_2 = 0$ describes the curve $C_0 = C_1 \cup C_2$. For small real ε , let C_ε be the curve described by $f_1 \cdot f_2 = \varepsilon$. If we consider the signs of the functions f_1, f_2 , and $f_1 \cdot f_2$, we get an idea of how C_ε

looks: for $\varepsilon < 0$, the curve consists of four kidney-shaped pieces; for $\varepsilon > 0$, it splits into two belts.

The kidney-shaped quartic is remarkable because (in contrast to quadrics and cubics) it has *bitangents*, which have two points of tangency with the curve. A careful count gives 28 of them.

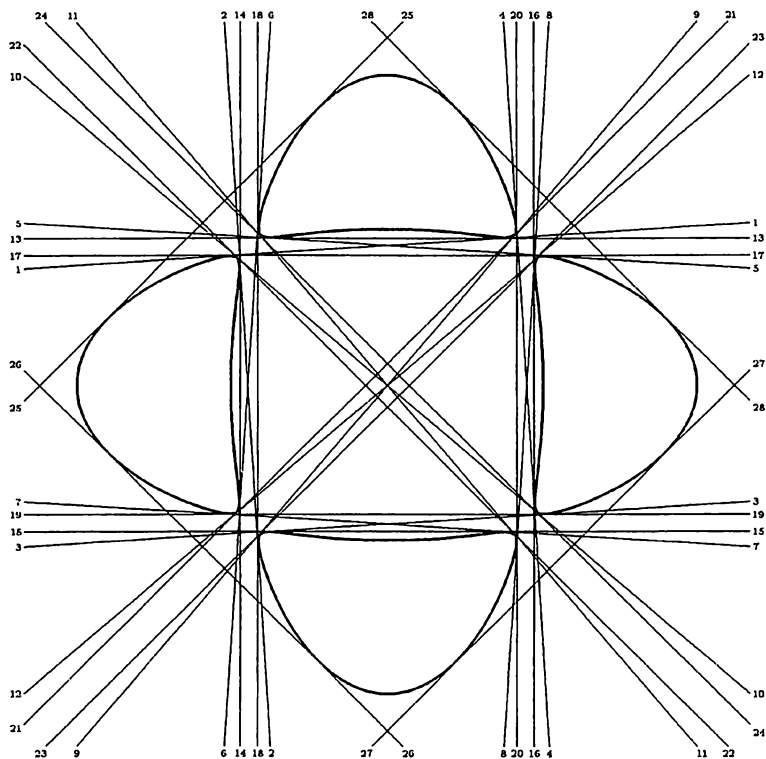

Figure 0.10. The 28 bitangents to the kidney-shaped quartic

For $\varepsilon > 0$, on the other hand, C_ε has only four real bitangents.

0.8. There is a good reason why almost all the curves introduced so far have had polynomial equations. You can already see from the rationality condition for hypocycloids how rare this is for curves parametrized in an elementary way.

Things can become quite pathological when the curve admits only a continuous parametrization. One example is the *Peano curve*, a continuous surjective map

$$\varphi : I \rightarrow I \times I, \quad \text{where } I = [0, 1].$$

φ is constructed as the uniform limit of piecewise linear maps. In 1890 Hilbert, in Bremen, illustrated it to the Association of German Natural Scientists and Physicians as follows:

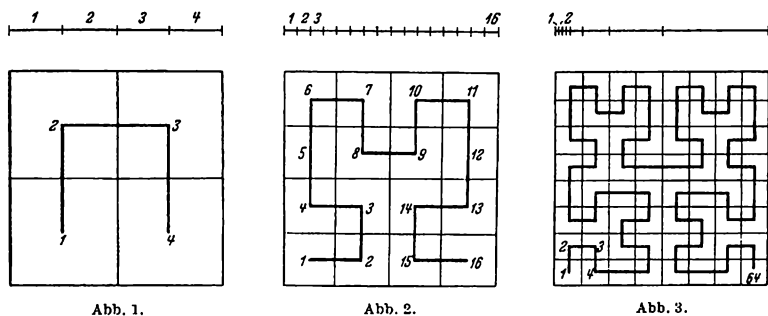

Figure 0.11. Peano curve

The trace of the curve in this case is the whole square, so just looking at the trace gives absolutely no idea how the “curve” was formed.

In constructing the *snowflake curve* (see Figure 0.12), we can think of a geographer who wants to draw the coastline of Brittany with greater and greater accuracy.

We start with an equilateral triangle and, at each stage, attach a triangle with sides of length $a/3$ to each existing side of length a .

The length of the curve increases at each step by the factor $4/3$. The uniform limit of this sequence is a continuous curve that is nowhere rectifiable; we can no longer write an equation for its trace.

The last examples should show above all that whoever is interested in particular regularity properties cannot avoid restricting the class of curves considered. The existence of a polynomial equation is a very rigid condition. But in this case we can expect more precise statements about (for instance) possible singularities, inflection

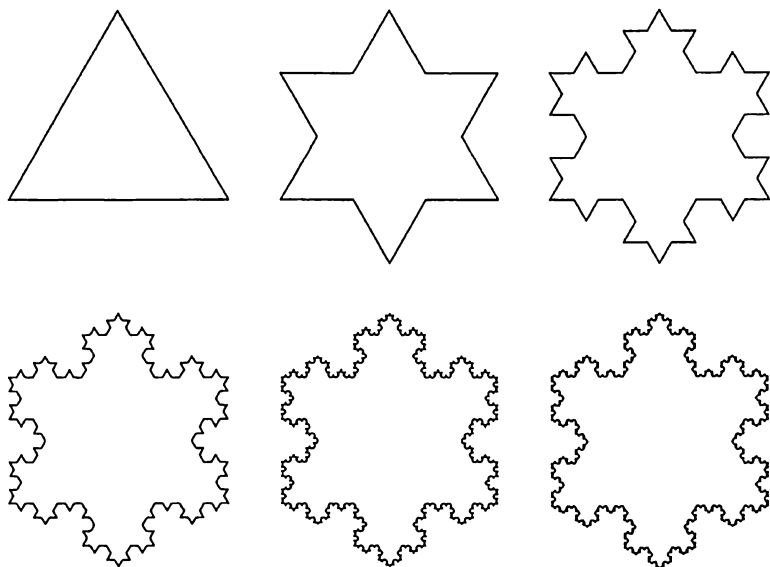

Figure 0.12. Snowflake curve

points, bitangents, and relations among their numbers. Finding these precise statements is the goal of the following chapters.

Exercise. Investigate the symmetry group of the kidney-shaped quartic of Section 0.7 and its action on the 28 bitangents.

Affine Algebraic Curves and Their Equations

1.1. By a theorem of H. Whitney, any closed subset of \mathbb{R}^n can be described as the set of zeros (or zero set) of an infinitely differentiable function ([B-J], Ch. 14). But even zero sets of polynomials in \mathbb{R}^2 don't always have the properties one expects of an "algebraic curve," as can be seen in very primitive examples. The following notation is useful: for $f \in \mathbb{R}[X_1, X_2]$, the set

$$V(f) := \{(x_1, x_2) \in \mathbb{R}^2 : f(x_1, x_2) = 0\}$$

is called the *variety* of f . Now, in \mathbb{R}^2 ,

$$V(X_1^2 + X_2^2 - 1) \quad \text{is a circle,}$$

$$V(X_1^2 + X_2^2) \quad \text{is a point, and}$$

$$V(X_1^2 + X_2^2 + 1) \quad \text{is the empty set.}$$

Only in the first case does it make sense to speak of a curve. The other two cases stop looking quite so odd when we pass from the real numbers to the complex numbers, that is, from the real plane \mathbb{R}^2 to the complex "plane" \mathbb{C}^2 . This is not surprising if we think about the effect of the field extension $\mathbb{R} \subset \mathbb{C}$ on polynomials of one variable. From the factorization

$$X_1^2 + X_2^2 = (X_1 + iX_2)(X_1 - iX_2),$$

it follows that in \mathbb{C}^2 we have

$$V(X_1^2 + X_2^2) = V(X_1 + iX_2) \cup V(X_1 - iX_2).$$

In other words, the zero set consists of two lines that intersect at the origin. This is the only real point on the curve. The change of variables $X_1 = iY_1$, $X_2 = iY_2$ turns the empty set in \mathbb{R}^2 into a circle with the equation

$$Y_1^2 + Y_2^2 - 1 = 0.$$

For polynomials of higher degree, the real parts of a complex variety can, depending on the position of the coordinates, turn out still more different from each other. The classical way out consists of developing the theory in the complex numbers and then occasionally returning to reality (see, for instance, [B-C-R] and Appendix 6).

1.2. This is the right time for a fundamental definition.

Definition. A subset $C \subset \mathbb{C}^2$ is called an *affine algebraic curve* if there exists a polynomial $f \in \mathbb{C}[X_1, X_2]$ such that $\deg f \geq 1$ and

$$C = V(f) = \{(x_1, x_1) \in \mathbb{C}^2 : f(x_1, x_2) = 0\}.$$

Since

$$V(f) = V(\lambda \cdot f) = V(f^k)$$

for $\lambda \in \mathbb{C}^*$ and $k \in \mathbb{N}^*$, it is obvious that the polynomial f for a given variety C cannot be uniquely determined. The main result of this chapter will be that this is essentially the only indeterminacy. The situation in the real numbers, on the other hand, is hopeless—as we have already seen in the example of the empty set.

The many technical advantages of passing from \mathbb{R} to \mathbb{C} are offset by a loss of direct intuition: from the real point of view, a “curve” in \mathbb{C}^2 is a surface in four-dimensional space. We will see in Chapter 9 that this leads to an interesting connection with the Riemann surfaces studied in complex function theory. From the various possibilities of distinguishing a plane in $\mathbb{C}^2 = \mathbb{R}^4$ as “real”, the various real curves arise as intersections of a surface in \mathbb{R}^4 with different planes.

1.3. Every polynomial $f \in \mathbb{C}[X_1, X_2]$ of degree ≥ 1 has an associated curve $V(f) \subset \mathbb{C}^2$. If f is a divisor of g , i.e. if $g = f \cdot h$, then $V(f) \subset V(g)$. Since the ring of polynomials is a unique factorization domain, we have a good general idea of the divisibility properties of polynomials; we would like to use these to draw conclusions about the possible subcurves of a given curve. The following lemma will help us find our way back from the loci of the curves to the polynomials.

Study's lemma. *Let $f, g \in \mathbb{C}[X_1, X_2]$. If f is irreducible of degree ≥ 1 and $V(f) \subset V(g)$, then f is a divisor of g .*

The analogous statement in the real numbers is obviously false (for $f = X_1^2 + X_2^2$ and $g = X_1$, for instance). This technical lemma is a precursor of the *Hilbert Nullstellensatz* ([Z-S], vol. II, p. 164). In the special case of curves, the Nullstellensatz says:

Corollary. *If $f \in \mathbb{C}[X_1, X_2]$ is not a unit, then $V(f) \neq \emptyset$.*

Proof. Suppose $V(f) = \emptyset$. If h is an irreducible factor of f , then $V(h) = \emptyset$. By the lemma, h divides every g . But this is impossible. \square

For the *proof of Study's lemma* we use a classical geometric method that allows us, by means of a resultant, to reduce the assertion to the fundamental theorem of algebra (see [Wae], [B-K], for instance). Let

$$\begin{aligned} f &= a_0 X_2^m + a_1 X_2^{m-1} + \cdots + a_m, \\ g &= b_0 X_2^n + b_1 X_2^{n-1} + \cdots + b_n, \end{aligned}$$

where $a_\mu, b_\nu \in \mathbb{C}[X_1]$ and $a_0, b_0 \neq 0$. Perhaps after switching X_1 and X_2 , we may assume that $m \geq 1$. Now consider the sets $V(f) \subset V(g)$ and intersect them with the vertical lines $X_1 = x_1$ for all $x_1 \in \mathbb{C}$. We must also have $n > 0$: otherwise choose x_1 such that $a_0(x_1) \neq 0$ and $b_0(x_1) \neq 0$; then $V(f)$ would intersect the line $X_1 = x_1$ but $V(g)$ would not. (See Figures 1.1 and 1.2.)

Now consider the resultant $R_{f,g} \in A$, where $A = \mathbb{C}[X_1]$ (see Appendix 1). Our f was assumed to be irreducible, so if $R_{f,g} = 0$, then f is a divisor of g by Theorem A.1. Since $R_{f,g} \in A$ is itself a polynomial, we need only show that $R_{f,g}(x_1) = 0$ for infinitely many $x_1 \in \mathbb{C}$.

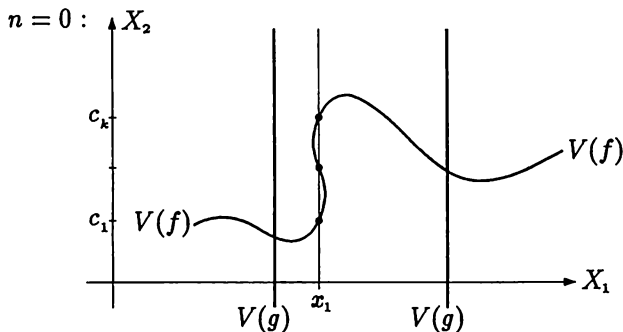

Figure 1.1. $n = 0$

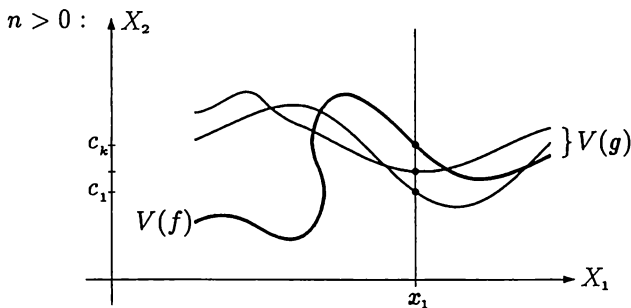

Figure 1.2. $n > 0$

Since $a_0, b_0 \neq 0$, we have $a_0(x_1), b_0(x_1) \neq 0$ for almost all $x_1 \in \mathbb{C}$. Setting $X_1 = x_1$ in f and g yields polynomials $f_{x_1}, g_{x_1} \in \mathbb{C}[X_2]$. If f_{x_1} has a zero $c \in \mathbb{C}$, so does g_{x_1} . Hence

$$X_2 - c$$

is a nonconstant common factor of f_{x_1} and g_{x_1} in $\mathbb{C}[X_2]$. We conclude that $R_{f,g}(x_1) = R_{f_{x_1},g_{x_1}} = 0$ by using the resultant theorem with $A = \mathbb{C}$. □

This method of projecting a curve on an axis also easily gives the following result.

Remark. *An algebraic curve $C \subset \mathbb{C}^2$ contains infinitely many points.*

1.4. Of the numerous consequences of Study's lemma, the first one we discuss is the decomposition of an algebraic curve into components. Since rings of polynomials over fields are unique factorization domains, every $f \in \mathbb{C}[X_1, X_2]$ admits a factorization

$$f = f_1^{k_1} \cdot \dots \cdot f_r^{k_r},$$

where the f_ρ are irreducible and no two of them are associates. This factorization is unique up to units and the order in which the f_i occur. Hence

$$V(f) = V(f_1) \cup \dots \cup V(f_r);$$

in other words, the curve defined by f can be decomposed into *components* $V(f_\rho)$. The following definition makes this precise.

Definition. An algebraic curve $C \subset \mathbb{C}^2$ is called *reducible* if there exist algebraic curves C_1, C_2 such that $C_1 \neq C_2$ and $C = C_1 \cup C_2$ (by Section 1.3, $C_i \neq \emptyset$). *Irreducible* means not reducible; that is, for every decomposition $C = C_1 \cup C_2$ it follows that $C_1 = C_2$.

We now translate this condition on the loci into algebra.

Lemma. *An algebraic curve $C = V(f) \subset \mathbb{C}^2$ is irreducible if and only if there exist $k \in \mathbb{N}^*$ and an irreducible $g \in \mathbb{C}[X_1, X_2]$ such that $f = g^k$.*

Proof. Let C be irreducible and let $f = f_1 \cdot f_2$, where f_1, f_2 are relatively prime nonunits. If h is an irreducible factor of f_1 , then h also divides f_2 because of the containment $V(h) \subset V(f_1) = V(f_2)$ and Study's lemma.

Conversely, let C be reducible, i.e. $V(f) = V(f_1) \cup V(f_2)$ and $V(f_1) \neq V(f_2)$. Then there exist irreducible factors h_i of f_i that are not associates of each other. The containment $V(h_i) \subset V(f)$ and Study's lemma imply that f has at least two distinct prime factors. \square

Theorem. *Any algebraic curve $C \subset \mathbb{C}^2$ admits a representation*

$$C = C_1 \cup \dots \cup C_r,$$

where C_1, \dots, C_r are irreducible algebraic curves. The representation is unique up to the order in which the C_i occur.

The C_i are called *irreducible components*.

Proof. Existence follows from the lemma and the prime factorization of a defining polynomial for the curve. For uniqueness, it remains to show that any irreducible curve $C' \subset C$ occurs among the C_ρ . But if $C' = V(f')$, where f' is irreducible, then by Study's lemma f' must be a prime factor of f . \square

1.5. The irreducible components of an algebraic curve correspond to the connected components of a topological space. In addition to this rather formal analogy, there is a far more interesting relationship.

Theorem. *Any irreducible curve $C \subset \mathbb{C}^2$ is connected as a topological space.*

This will be proved in Section 9.5, as a corollary of the resolution of singularities.

It seems almost unnecessary to point out that all the statements proved in the last sections are false in the real numbers. The hyperbola, for instance, consists of two connected components but is described by an irreducible polynomial. A single branch is not an algebraic set in \mathbb{R}^2 . (Prove this.)

1.6. As we saw in Section 1.4, the irreducible components of an algebraic curve are uniquely determined. By Study's lemma, this also determines the possible irreducible factors of a defining polynomial:

Corollary. *Let $C = V(f) \subset \mathbb{C}^2$ be an algebraic curve, and let*

$$f = f_1^{k_1} \cdot \dots \cdot f_r^{k_r}$$

be a prime factorization. If $C = V(g)$ for some other polynomial g , then

$$g = \lambda f_1^{l_1} \cdot \dots \cdot f_r^{l_r},$$

where $\lambda \in \mathbb{C}^$ and $l_\rho \in \mathbb{N}^*$.*

This gives us a complete overview of the possible equations for C . By analogy with polynomials of one variable, we may call

$$\tilde{f} = f_1 \cdot \dots \cdot f_r$$

a *minimal polynomial* for the curve. It is unique, up to a unit, and has the following algebraic property:

$$\mathfrak{I}(C) := \{h \in \mathbb{C}[X_1, X_2] : h|_C = 0\}$$

is an ideal in the ring of polynomials. $\mathfrak{I}(C)$ is called the *ideal* of C . It is a principal ideal, generated by a minimal polynomial.

For a curve C that is not described by a minimal polynomial, the power k_ρ can be regarded as the multiplicity of the component $C_\rho = V(f_\rho)$. In general, a formal combination

$$k_1 C_1 + \cdots + k_r C_r,$$

where C_ρ is irreducible and $k_\rho \in \mathbb{Z}$, is called a *divisor*; if $k \geq 0$, it is called *effective*. These generalizations make sense in the case where one encounters a curve through a polynomial or a rational function rather than as a set of points.

1.7. We can now use the minimal polynomial to define the most important *invariant* of an algebraic curve, its *degree*:

Definition. If $C = V(f) \subset \mathbb{C}^2$ is an algebraic curve and f a minimal polynomial, then

$$\deg C := \deg f$$

is the *degree of the curve* C . If f is not necessarily a minimal polynomial, one speaks of the *degree of the divisor*.

In order to explain the geometric meaning of the degree, we consider intersections of the curve with lines. Let a line $L \subset \mathbb{C}^2$ be given by the parametrization

$$\varphi : \mathbb{C} \rightarrow L \subset \mathbb{C}^2, \quad t \mapsto (\varphi_1(t), \varphi_2(t)),$$

where $\varphi_i \in \mathbb{C}[T]$ are linear polynomials. If $C = V(f) \subset \mathbb{C}^2$, we obtain a polynomial

$$g(T) := f(\varphi_1(T), \varphi_2(T)),$$

and the zeros of g correspond to the points of intersection of C with L . Now it is easy to estimate how many there are, in symbols $\#(C \cap L)$. Since $g = 0$ is equivalent to $L \subset C$, the inequality $\deg g \leq \deg f$ implies the following:

Remark. If $C \subset \mathbb{C}^2$ is an algebraic curve of degree n and $L \subset \mathbb{C}^2$ is a line such that $L \not\subset C$, then

$$\#(C \cap L) \leq n.$$

Of course, an analogue of this holds in the real numbers and gives a way to show that certain subsets of \mathbb{R}^2 or \mathbb{C}^2 cannot be algebraic curves: for instance, the sine curve, the cycloid, or the hypocycloid with irrational ratio of the radii. In each case, there are lines that are not completely contained in the curve but intersect it in infinitely many points.

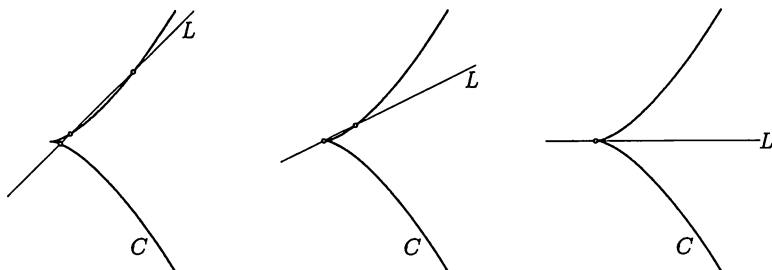

Figure 1.3. Points of intersection of the cuspidal cubic with lines

1.8. The bound given in Section 1.7 for the number of points of intersection with a line is seldom attained in the real numbers but “almost always” in the complex numbers. To make this precise, we again consider the construction of the polynomial $g(T) = f(\varphi(T))$ that determines the points of intersection. If $0 \leq d \leq n = \deg f$, then

$$f = f_{(0)} + f_{(1)} + \cdots + f_{(n)}, \quad \text{where}$$

$$f_{(d)} = \sum_{k_1+k_2=d} a_{k_1 k_2} X_1^{k_1} X_2^{k_2},$$

denotes the *homogeneous part* of degree d of f . If

$$\varphi_1 = \lambda_1 T + \mu_1, \quad \varphi_2 = \lambda_2 T + \mu_2,$$

then the coefficient of T^n in g is $f_{(n)}(\lambda_1, \lambda_2)$. Because $f_{(n)} \neq 0$, $f_{(n)}$ can vanish for at most n distinct slopes $\lambda_1 : \lambda_2$ of L . For all

the remaining slopes, $\deg g = \deg f = \deg C$. Thus there are two obstructions to attaining the bound $\#(C \cap L) = \deg C$:

- a) The line L may have an exceptional slope.
- b) The polynomial g may have multiple zeros.

The second problem can be resolved by counting points of intersection with their multiplicities, and the first by also considering points of intersection at infinity. In the simplest case, C itself is a line, and the only exceptional slope occurs when L is parallel to C .

The Projective Closure

2.1. Even in elementary geometry, extending the affine space K^n over a field K to the projective space $\mathbb{P}_n(K)$ can be useful. A compelling example is the classification of the quadrics; moreover, if $K = \mathbb{C}$, the only projective invariant left is the *rank* of the quadratic form (see for instance [Fi], 3.5.9). The behavior at infinity of algebraic curves of higher degree can be much more complicated, so we have to include these points at the outset, as having equal rights.

According to Dieudonné [D], the “golden age of projective geometry” lasted from 1795 (when Monge’s *Géométrie* appeared) until 1850 (when Riemann’s ideas led geometry onto new paths). It is typical of projective geometry that it can be treated algebraically by elementary means, while an attempt at geometrically visualizing not just imaginary points but even points at infinity is quite hard and not always helpful. F. Klein grappled exhaustively with these questions ([Kl], p. 126 ff).

2.2. First, a necessarily brief review of the basic ideas of projective geometry. We restrict our attention to the plane (i.e. $n = 2$); the field K can be arbitrary.

Let $\mathbb{P}_2(K)$ denote the *projective plane over K* , that is, the set of all lines through the origin in K^3 . If $0 \neq x = (x_0, x_1, x_2) \in K^3$, then

$$(x_0 : x_1 : x_2) = K \cdot (x_0, x_1, x_2)$$

denotes the line through x —thus it is a point in $\mathbb{P}_2(K)$. For computations with these *homogeneous coordinates*, we have the rule

$$(x_0 : x_1 : x_2) = (y_0 : y_1 : y_2) \Leftrightarrow (x_0, x_1, x_2) = \lambda(y_0, y_1, y_2),$$

where $\lambda \in K^*$. The *canonical embedding* of the affine plane is given by

$$\iota : K^2 \rightarrow \mathbb{P}_2(K), \quad (x_1, x_2) \mapsto (1 : x_1 : x_2).$$

The set of *points at infinity* of K^2 is

$$\mathbb{P}_2(K) \setminus \iota(K^2) = \{(x_0 : x_1 : x_2) \in \mathbb{P}_2(K) : x_0 = 0\},$$

a projective line $\mathbb{P}_1(K)$. Every point at infinity $(0 : x_1 : x_2)$ has a corresponding *direction* $x_1 : x_2$ in K^2 . Instead of the line $x_0 = 0$, any other line in $L \subset \mathbb{P}_2(K)$ can take on the role of the points at infinity of the affine plane $\mathbb{P}_2(K) \setminus L$.

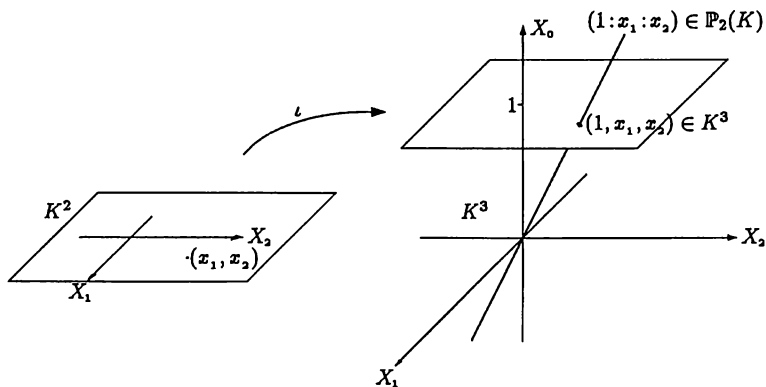

Figure 2.1. The canonical embedding of K^2 in $\mathbb{P}_2(K)$

The real projective plane $\mathbb{P}_2(\mathbb{R})$ is a nonorientable manifold. The configuration of the lines with equations $x_\nu = 0$ can be sketched as in Figure 2.2.

In this figure, you have to imagine that each of the lines shown is part of a closed line that has the same topological type as the circle; if you consider a narrow strip around it in $\mathbb{P}_2(\mathbb{R})$, you get a Möbius strip with the circle as core.

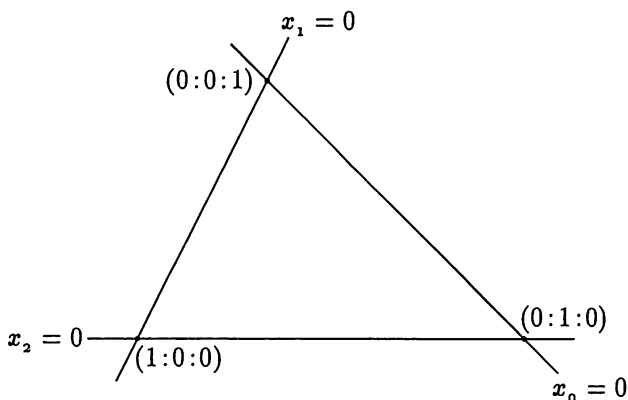

Figure 2.2. The fundamental triangle of the projective plane

2.3. We will now extend an affine curve $C \subset K^2$ to a projective curve $\overline{C} \subset \mathbb{P}_2(K)$. To do this, we must decide which points at infinity to adjoin. If $K = \mathbb{R}$ or \mathbb{C} , then \mathbb{P}_2 , as the quotient of K^3 , has a topology, and an obvious possibility is to define \overline{C} to be the topological closure. Then for every line that is an asymptote of the curve, the corresponding point at infinity is adjoined. If the curve C is algebraic, then there are only finitely many of them, and the topological construction above can be described by a simple computation with polynomials, as follows.

If $F \in K[X_0, X_1, X_2]$ is a homogeneous polynomial, then

$$V(F) := \{(x_0 : x_1 : x_2) \in \mathbb{P}_2(K) : F(x_0, x_1, x_2) = 0\}$$

is called the *variety* of F ; more precisely, $V(F)$ is the set of lines through 0 in the *affine cone*

$$\{(x_0, x_1, x_2) \in K^3 : F(x_0, x_1, x_2) = 0\}$$

corresponding to $V(F)$. For $f \in K[X_1, X_2]$, we now construct a homogeneous $F \in K[X_0, X_1, X_2]$, the *homogenization* of f , as follows: if $n = \deg f$ and

$$f(X_1, X_2) = f_{(0)} + f_{(1)} + \cdots + f_{(n)}$$

is its decomposition into homogeneous parts, where $f_{(n)} \neq 0$, then

$$F(X_0, X_1, X_2) := X_0^n f_{(0)} + \cdots + X_0 f_{(n-1)} + f_{(n)}.$$

Clearly

$$F = X_0^n f\left(\frac{X_1}{X_0}, \frac{X_2}{X_0}\right) \quad \text{and} \quad f = F(1, X_1, X_2).$$

Though these calculations are valid for arbitrary fields, we will speak of “curves” only when $K = \mathbb{C}$.

Definition. A subset $\overline{C} \subset \mathbb{P}_2(\mathbb{C})$ is called a *projective algebraic curve* if there is a homogeneous $F \in \mathbb{C}[X_0, X_1, X_2]$ such that $\deg F \geq 1$ and $\overline{C} = V(F)$.

If $C = V(f) \subset \mathbb{C}^2$ is an affine algebraic curve and F is the homogenization of f , then $\overline{C} = V(F) \subset \mathbb{P}_2(\mathbb{C})$ is called the *projective closure* of C .

Clearly $C = \overline{C} \cap \mathbb{C}^2$.

What the closure of a quadric looks like is well known. As an example, the reader is invited to consider the image of the parametrization

$$\varphi : \mathbb{P}_1(\mathbb{C}) \rightarrow \mathbb{P}_2(\mathbb{C}), \quad (t_0 : t_1) \mapsto (t_0^2 : t_0 t_1 : t_1^2).$$

For the cubic with

$$f = X_1^3 - X_2, \quad \text{the homogenization is} \quad F = X_1^3 - X_0^2 X_2.$$

It has an inflection point at $(1 : 0 : 0)$ and a cusp at $(0 : 0 : 1)$. (This point lies in the affine part with $X_2 = 1$ and coordinates (X_0, X_1) .)

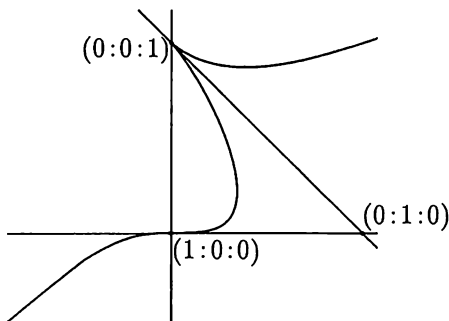

Figure 2.3. Projective closure of the cubical parabola

More examples will be given later.

Exercise. The projective closure \overline{C} of C defined above coincides with the topological closure of C in $\mathbb{P}_2(\mathbb{C})$.

It is crucial here that the ground field is \mathbb{C} , because an argument involving the continuity of the roots is needed (see Section 6.8).

2.4. The results proved in Chapter 1, using Study's lemma, about the possible *equations*, *irreducibility*, and *decomposition into components* of an affine algebraic curve have analogues for projective algebraic curves. This is an easy consequence of the following lemma.

Lemma. *Let $f \in K[X_1, X_2]$, and let $F \in K[X_0, X_1, X_2]$ be its homogenization. Then*

$$f \text{ is irreducible} \iff F \text{ is irreducible.}$$

Proof. Let F be reducible, so $F = G \cdot H$. Since F is homogeneous, so are G and H . This is obvious from the decomposition of F , G , and H into homogeneous parts. Since

$$f = F(1, X_1, X_2) = G(1, X_1, X_2) \cdot H(1, X_1, X_2) = g \cdot h,$$

f is reducible.

Conversely, if $f = g \cdot h$, then $F = G \cdot H$ for the homogenizations. □

As in Section 1.7, we define the *degree* of a (projective) algebraic curve $C \subset \mathbb{P}_2(\mathbb{C})$ to be the degree of a *minimal polynomial* F in $\mathbb{C}[X_0, X_1, X_2]$. The latter is homogeneous and generates the ideal

$$\mathcal{I}(C) = \{G \in \mathbb{C}[X_0, X_1, X_2] :$$

$$G(x_0, x_1, x_2) = 0 \text{ for all } (x_0 : x_1 : x_2) \in C\}.$$

The group $\text{PGL}_2(\mathbb{C})$ of projective transformations acts on $\mathbb{P}_2(\mathbb{C})$. It is isomorphic to the quotient of $\text{GL}(3, \mathbb{C})$ by the relation $A \sim \lambda A$ for $\lambda \in \mathbb{C}^*$. Since the homogeneous coordinates are transformed linearly, we can easily see that (for instance) the degree and the irreducibility of a curve are independent of projective transformations. Such numbers or properties are called *invariants*.

2.5. The most important result of elementary curve theory is Bézout's theorem, which gives the number of points of intersection of two algebraic curves. We begin by treating the special case of the intersection of a curve and a line.

Let $C = V(F) \subset \mathbb{P}_2(\mathbb{C})$ be a curve of degree $n \geq 1$. To simplify computations, choose coordinates so that the line L is described by $X_2 = 0$. Then the points of intersection of C and L correspond to the zeros of the polynomial $G(T_0, T_1) = F(T_0, T_1, 0)$ (see Section 1.7). Expand F in terms of X_2 ; that is, write

$$F(X_0, X_1, X_2) = F_0 X_2^n + F_1 X_2^{n-1} + \cdots + F_n,$$

where $F_\nu \in \mathbb{C}[X_0, X_1]$ are homogeneous and $\deg F_\nu = \nu$ if $F_\nu \neq 0$. Then $G = F_n$.

If $F_n = 0$, then F is divisible by X_2 ; equivalently, $L \subset C$. Otherwise $\deg G = n$ (this is not always true in the affine plane; see Section 1.8), and by the fundamental theorem of algebra (in its "homogeneous" form) there is a factorization

$$G = (b_1 T_0 - a_1 T_1)^{k_1} \cdots (b_m T_0 - a_m T_1)^{k_m},$$

where $(a_\mu : b_\mu) \in \mathbb{P}_1(\mathbb{C})$ ($\mu = 1, \dots, m$) are uniquely determined, distinct points, and $k_\mu \in \mathbb{N}^*$. It is not hard to prove that the powers k_μ that appear depend only on C and L , not on the choice of coordinates. Thus we can define the *intersection multiplicity* of C and L to be

$$\text{mult}_p(C \cap L) := k,$$

where $k = k_\mu$ for $p = (a_\mu : b_\mu : 0)$ and $k = 0$ for all other $p \in \mathbb{P}_2(\mathbb{C})$. Since $k_1 + \cdots + k_m = n$, we finally obtain the following improvement of the results of Section 1.8:

Proposition. *If $C \subset \mathbb{P}_2$ is a curve of degree $n \geq 1$ and L a line not contained in C , then the total number of points of intersection of C and L , counted with multiplicities, is n . For almost all lines L , the points of intersection $C \cap L$ are simple; that is, there are exactly n points of intersection.*

If $C = V(F)$, where F is not necessarily a minimal polynomial, then the first statement remains true if we regard $n = \deg F$ as the degree of the divisor (see Section 1.6). If F has repeated prime factors,

then the powers of the corresponding linear factors increase accordingly, and so do the multiplicities.

To prove the second statement, we can use a discriminant to pick out those lines that have at least one multiple intersection point with C (see Section 5.1). This effort can be avoided by applying Corollary 4.3 (thus implicitly using Bézout's theorem).

Example. Let $C = V(X_0X_2^2 - X_1^3)$ be the projective closure of the cuspidal cubic, and let the line L be parametrized by

$$(T_0, T_1) \mapsto (T_0, \lambda_0 T_1, \lambda_1 T_1) = X(T).$$

It passes through $p = (1 : 0 : 0)$, and $(\lambda_0 : \lambda_1) \in \mathbb{P}_1(\mathbb{C})$ determines its slope in the affine plane. Then

$$F(X(T)) = G(T) = T_1^2(\lambda_1^2 T_0 - \lambda_0^3 T_1).$$

The factor T_1^2 describes the point of intersection p , and the second factor describes a point of intersection $q = (\lambda_0^3 : \lambda_0 \lambda_1^2 : \lambda_1^3)$. If the line is horizontal, then $(\lambda_0 : \lambda_1) = (1 : 0)$, so $p = q$ and $\text{mult}_p(C \cap L) = 3$. In Chapter 3 this line will be called a *cuspidal tangent*. Otherwise $p \neq q$ and

$$\text{mult}_p(C \cap L) = 2, \quad \text{mult}_q(C \cap L) = 1.$$

For $(\lambda_0 : \lambda_1) = (0 : 1)$, $q = (0 : 0 : 1)$ is an inflection point at infinity, but L is not the inflectional tangent.

The latter is the line at infinity $L' = V(X_0)$, and

$$\text{mult}_q(C \cap L') = 3.$$

2.6. Now we determine the number of points of intersection of two algebraic curves $C_1 = V(F_1)$ and $C_2 = V(F_2)$ in $\mathbb{P}_2(\mathbb{C})$. To do this, we cover the plane by a family of lines, as in the proof of Study's lemma in Section 1.3. We may assume that the curves do not pass through $q = (0 : 0 : 1)$. For a point $x = (x_0 : x_1 : 0)$, let $L_x = x \vee q$ denote the line containing x and q . We can use a resultant to tell whether there is a point of intersection on L_x . We expand in terms of X_2 (the variable along one of the lines):

$$F_1 = a_0 X_2^m + a_1 X_2^{m-1} + \cdots + a_m,$$

$$F_2 = b_0 X_2^n + b_1 X_2^{n-1} + \cdots + b_n.$$

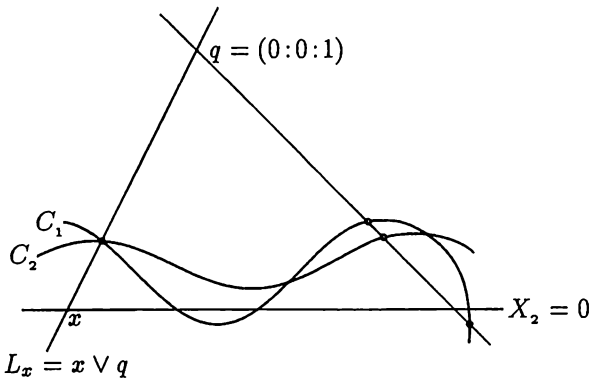

Figure 2.4. Number of points of intersection of two algebraic curves

Here $a_\mu, b_\nu \in \mathbb{C}[X_0, X_1]$ are homogeneous and $\deg a_\mu = \mu$, $\deg b_\nu = \nu$ if $a_\mu, b_\nu \neq 0$. Since $q \notin C_1$ and $q \notin C_2$, we have $a_0 \neq 0$ and $b_0 \neq 0$. We take the resultant

$$G = R_{F_1, F_2}.$$

By Theorem A.1.3, $G \in \mathbb{C}[X_0, X_1]$ is homogeneous of degree mn . In the special case that $C_2 = V(X_2)$ is a line, the resultant becomes $G = \pm a_m$, as in Section 2.5.

If C_1 and C_2 have no common component, then $G \neq 0$ by Theorem A.1.1. Moreover, $G(x_0, x_1) = 0$ if and only if C_1 and C_2 have a point of intersection on L_x . For fixed x , there are only finitely many points of intersection because otherwise L_x would be a common component of C_1 and C_2 . Hence $C_1 \cap C_2$ is finite.

Now we count the points of intersection. There are only finitely many lines connecting them. If the coordinates are chosen so that q lies on none of these lines, then there is at most one point of intersection on each line L_x . In other words, altogether there are at most as many as the zeros of the resultant G . This gives a theorem.

Theorem. *If $C_1, C_2 \subset \mathbb{P}_2(\mathbb{C})$ are algebraic curves with no common component, then the number of points of intersection satisfies the inequality*

$$\#(C_1 \cap C_2) \leq \deg C_1 \cdot \deg C_2.$$

2.7. To turn the inequality proved above into an equality, we have to count the points of intersection with their multiplicities. The hardest part is defining the *intersection multiplicity*. It should generalize the definition in Section 2.5 (where one of the curves is a line), and it should satisfy Bézout's theorem. The most reliable way to do this is through the following definition.

Definition. Let $C_1 = V(F_1)$, $C_2 = V(F_2) \subset \mathbb{P}_2(\mathbb{C})$ be algebraic curves that have no common component and lie in the following position: They do not pass through the point $q = (0 : 0 : 1)$, and on each line through q there is at most one point of intersection of C_1 and C_2 . As in Section 2.6, let $G \in \mathbb{C}[X_0, X_1]$ be the resultant of F_1 and F_2 . If

$$p = (p_0 : p_1 : p_2) \in C_1 \cap C_2 \quad \text{and} \quad p' = (p_0 : p_1),$$

then

$$\text{mult}_p(C_1 \cap C_2) := \text{ord}_{p'}(G);$$

that is, the *intersection multiplicity* of C_1 and C_2 is the order of the zero of G at p' .

Combining this definition with the arguments of Section 2.6 immediately gives the following theorem, which was discovered in 1765.

Bézout's theorem. *For algebraic curves $C_1, C_2 \subset \mathbb{P}_2(\mathbb{C})$ that have no common component,*

$$\sum_{p \in C_1 \cap C_2} \text{mult}_p(C_1 \cap C_2) = \deg C_1 \cdot \deg C_2.$$

It is clear from the computation in Section 2.6 that Bézout's theorem also holds for *effective divisors* (see Section 1.6). In other words, it is completely unnecessary that the polynomial F_i be a minimal polynomial of C_i . If there are multiple components, the intersection multiplicity is increased by an appropriate factor.

Bézout's theorem will be used routinely in the following sections. First we give a very simple example.

Example. If $C_1 = V(X_2^3 - X_0X_1^2)$ and $C_2 = V(X_2^3 + X_0X_1^2)$, then

$$G(X_0, X_1) = 8X_0^3X_1^6.$$

Thus the two cubics intersect at $q = (0 : 1 : 0)$ with multiplicity 3, and at $p = (1 : 0 : 0)$ with multiplicity 6. The point q is a common inflection point, with inflectional tangent $X_0 = 0$.

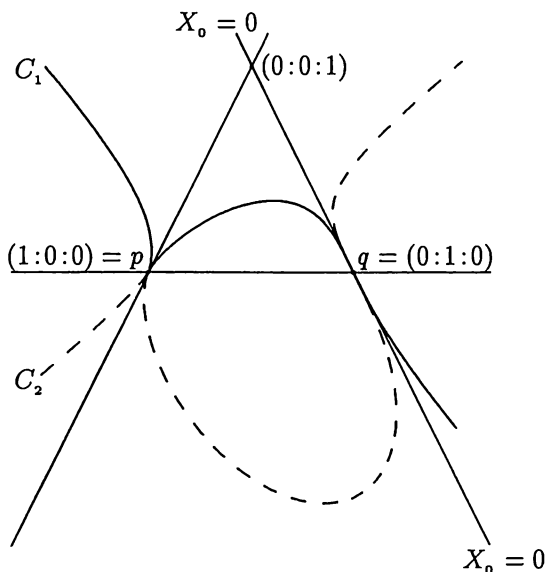

Figure 2.5. Intersection of the cubics $C_1 = V(X_2^3 - X_0X_1^2)$ and $C_2 = V(X_2^3 + X_0X_1^2)$

Defining the intersection multiplicity via the resultant has the advantages of making Bézout's theorem clear and giving us a way to compute with confidence. On the other hand, this definition is a bit inelegant for many theoretical arguments, and does not lead directly to a clear understanding of the geometric background: a small change in the curves involved (that is, a small change in their equations) will turn an intersection point of multiplicity k into k distinct simple intersection points. This follows essentially because the resultant depends continuously on the coefficients, and a multiple zero of a polynomial splits into several simple zeros under a small perturbation of the coefficients. Justifying all this precisely is rather hard, and the necessary tools will not be available until Chapter 8. It will turn out that the intersection multiplicity is a *local* invariant: it is determined by the behavior of the two curves in an arbitrarily small neighborhood of the

point of intersection. Until we have this result, computing with the resultant is a bit mysterious.

In the example above, consider how the common inflection point splits into 3 points of intersection. Small perturbations of the cuspidal cubic result in cubics, which intersect each other near p in 6 points.

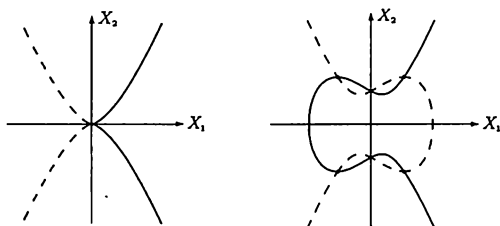

Figure 2.6. Cuspidal cubic, unperturbed and with small perturbations

If we want to compute the points of intersection of two algebraic curves explicitly, then with the resultant method we need only compute the zeros of polynomials in one variable. First, the resultant gives those lines on which points of intersection lie. On each of these lines, the points of intersection are found as common zeros of two polynomials. In simple examples the zeros of these polynomials can easily be seen; in complicated cases they have to be approximated numerically.

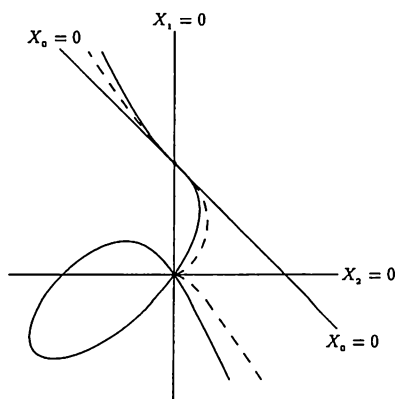

Figure 2.7. Intersection of the cuspidal cubic with the nodal cubic

Exercises. Determine the points of intersection (with their multiplicities) of the following curves:

- a) $V(X_0X_2^2 - X_1^3)$ (cuspidal cubic) with
 $V(X_0X_2^2 - X_1^2(X_1 + X_0))$ (nodal cubic).
- b) The nodal cubic (as in (a)) with
 $V(X_1^2 + X_2^2 + X_0X_1)$ (circle of curvature) and with
 $V(X_0^2 + 2X_1^2 + X_2^2 + 3X_0X_1)$ (ellipse).

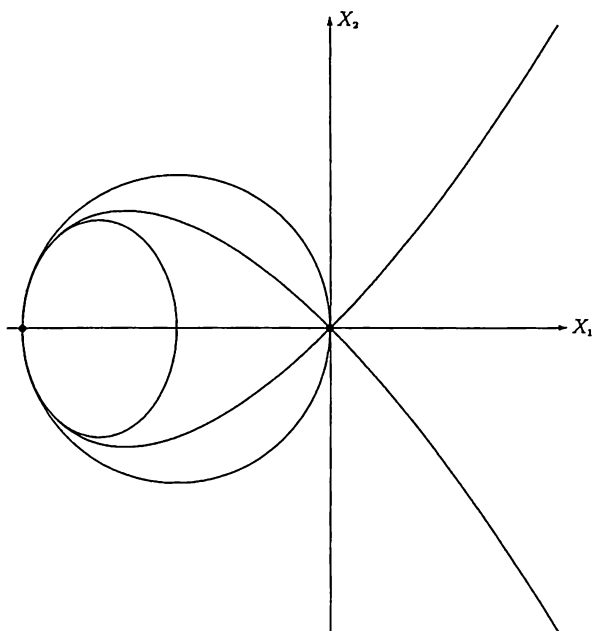

Figure 2.8. Intersection of the nodal cubic with a circle of curvature and an ellipse

Tangents and Singularities

3.1. Bézout's theorem, which we proved in the last chapter, has both a local and a global aspect: the intersection multiplicity is determined by the behavior of the curves near the point of intersection, but all the points (even those at infinity) have to be included in the overall sum. The local properties of a curve can be studied in an affine part of projective space, and we start by doing this a bit more precisely.

Definition. Let the algebraic curve $C = V(f) \subset \mathbb{C}^2$ be described by a minimal polynomial $f \in \mathbb{C}[X_1, X_2]$. We say that C is *smooth* at a point $p \in C$ if

$$\text{grad}_p f := \left(\frac{\partial f}{\partial X_1}(p), \frac{\partial f}{\partial X_2}(p) \right) \neq (0, 0).$$

Instead of *not smooth*, we say *singular*.

It is important to use a minimal polynomial because for $f = g^k$ with $k \geq 2$, C would be singular at every point.

If C is smooth at p , the line

$$T_p C := \left\{ (x_1, x_2) \in \mathbb{C}^2 : \frac{\partial f}{\partial X_1}(p) \cdot x_1 + \frac{\partial f}{\partial X_2}(p) \cdot x_2 = c \right\}$$

is called the *tangent to C at p* . Here $c \in \mathbb{C}$ is chosen so that $p \in T_p C$. Just as for differentiable curves, the tangent is the line through p that, near p , passes as close to C as possible.

Examples of singularities are the cusp of the cuspidal cubic (Section 0.3); the origin in the case of the nodal cubic (Section 0.4) and the folium of Descartes (Section 0.5); the cusps of cycloids (Section 0.6); and the points of intersection of the ellipses in the quartic C_0 of Section 0.7. In general, every point of intersection of components is singular. The best way to justify this precisely is to use the implicit function theorem (Section 6.9).

3.2. The set $\text{Sing } C := \{p \in C : C \text{ is singular at } p\}$ is called the *singular locus* of C . Here is a first nontrivial property of this set.

Proposition. *For an algebraic curve $C \subset \mathbb{C}^2$, $\text{Sing } C$ is finite.*

Proof. If $C = V(f)$, set $C_i := V(\partial f / \partial X_i)$. Then

$$\text{Sing } C = C \cap C_1 \cap C_2.$$

We may assume that $\deg C = \deg f \geq 2$, since a line is smooth at every point. This also implies that for some i , $\deg(\partial f / \partial X_i) \geq 1$; without loss of generality, let $i = 1$. Then C_1 is an algebraic curve, and $\text{Sing } C \subset C \cap C_1$. Thus it suffices to show that $C \cap C_1$ is finite. To do this, we use Bézout's theorem in the form for divisors because $\partial f / \partial X_1$ is not necessarily a minimal polynomial of C_1 (take $f = X_1 X_2^2 + 1$, for instance). It remains to show that C and C_1 have no common component.

Suppose f and $\partial f / \partial X_1$ have a common prime factor g . Then

$$f = g \cdot h \quad \text{and} \quad \frac{\partial f}{\partial X_1} = g \cdot h_1 = h \frac{\partial g}{\partial X_1} + g \frac{\partial h}{\partial X_1}.$$

Hence g is also a divisor of $h \cdot \partial g / \partial X_1$. If $\partial g / \partial X_1 \neq 0$, then g is a divisor of h , so g^2 is a divisor of f . But this contradicts the fact that f is a minimal polynomial.

If $\partial g / \partial X_1 = 0$, then $g = X_2 - a$. But the coordinates can be chosen at the outset so that C contains no lines parallel to the axes. \square

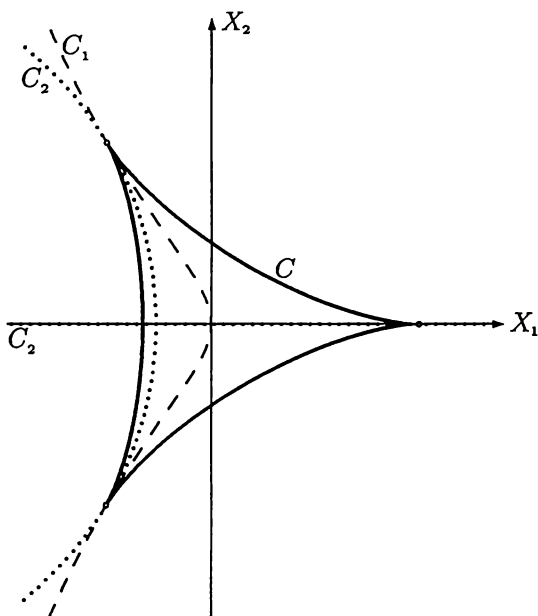

Figure 3.1. The singularities of the hypocycloid of three cusps

If $n = \deg C$, it follows that C has at most $n(n - 1)$ singular points. This is a very poor estimate. It will be improved in Section 3.8.

3.3. To get a first measure of the nastiness of a singularity, we consider higher derivatives of the defining polynomial. Let $f \in \mathbb{C}[X_1, X_2]$, and let $p = (p_1, p_2) \in \mathbb{C}^2$ be a fixed point. The substitution

$$X_i = p_i + (X_i - p_i)$$

gives the *Taylor expansion* of f about p :

$$f(X_1, X_2) = \sum_k f_{(k)}, \quad \text{where } f_{(k)} = \sum_{\mu+\nu=k} a_{\mu\nu} (X_1 - p_1)^\mu (X_2 - p_2)^\nu$$

and

$$a_{\mu\nu} = \frac{1}{\mu!\nu!} \frac{\partial^{\mu+\nu} f}{\partial X_1^\mu \partial X_2^\nu}(p).$$

Thus the *order of f at p* can be defined as

$$\text{ord}_p(f) := \min\{k : f_{(k)} \neq 0\}.$$

If f is a minimal polynomial of the curve $C \subset \mathbb{C}^2$, then

$$\text{ord}_p(C) := \text{ord}_p(f)$$

is the *order of C at p* . It is clear that

- a) $0 \leq \text{ord}_p(C) \leq \deg C$;
- b) $p \in C \Leftrightarrow \text{ord}_p(C) > 0$;
- c) C is smooth at $p \Leftrightarrow \text{ord}_p(C) = 1$;
- d) C is singular at $p \Leftrightarrow \text{ord}_p(C) > 1$.

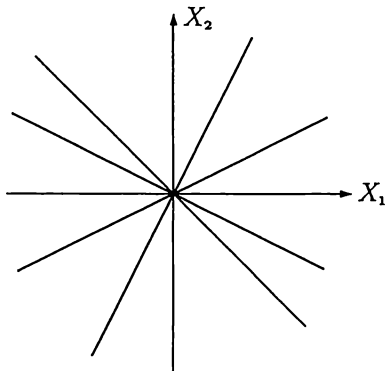

Figure 3.2. The extreme case $\text{ord}_p(C) = \deg C$

The extreme case $\text{ord}_p(C) = \deg C =: n$ occurs if and only if $f = f_{(n)}$. This means that C consists of n lines through p . Thus all the singular points of an irreducible cubic have order 2.

The origin has order 3 in the case of the quartic

$$V((X_1^2 + X_2^2)^2 + 3X_1^2X_2 - X_2^3) \quad (\text{three-leaf clover}),$$

and order 4 in the case of the sextic

$$V((X_1^2 + X_2^2)^3 - 4X_1^2X_2^2) \quad (\text{four-leaf clover}).$$

In these examples, the order counts the “local branches” of the curve (see Section 6.14). The *ovoid*,

$$V((X_1^2 + X_2^2)^2 - X_1^3),$$

a quartic with order 3 at the origin, looks completely different.

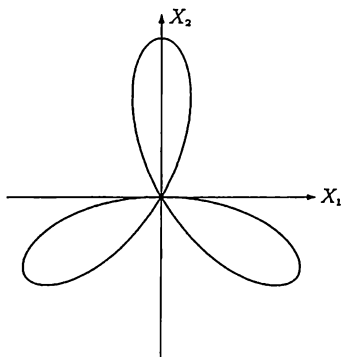

Figure 3.3. Three-leaf clover

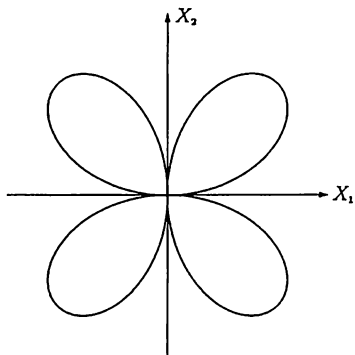

Figure 3.4. Four-leaf clover

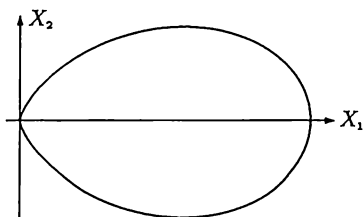

Figure 3.5. Ovoid

Proposition. *Let $C \in \mathbb{P}_2(\mathbb{C})$ be a curve that has no lines as components and has a point p such that $\text{ord}_p(C) = \deg C - 1$. Then C admits a rational parametrization, i.e. there exists a surjective map*

$$\varphi : \mathbb{P}_1(\mathbb{C}) \rightarrow C \subset \mathbb{P}_2(\mathbb{C}), \quad t = (t_0 : t_1) \mapsto (\varphi_0(t) : \varphi_1(t) : \varphi_2(t)),$$

where $\varphi_i \in \mathbb{C}[T_0, T_1]$ are homogeneous of degree $\deg C$.

Proof. Let $C = V(F)$ and $n = \deg F$. Assume that $p = (0, 0) \in \mathbb{C}^2$. Then

$$f(X_1, X_2) = F(1, X_1, X_2) = f_{(n-1)} + f_{(n)}.$$

We consider the line through p with slope corresponding to the parameter $(t_0 : t_1)$, so

$$x_1 = \lambda t_0, \quad x_2 = \lambda t_1, \quad \text{where } \lambda \in \mathbb{C}.$$

Intersecting this line with C gives

$$\begin{aligned} 0 &= f_{(n-1)}(\lambda t_0, \lambda t_1) + f_{(n)}(\lambda t_0, \lambda t_1) \\ &= \lambda^{n-1} f_{(n-1)}(t_0, t_1) + \lambda^n f_{(n)}(t_0, t_1) \\ &= \lambda^{n-1} (f_{(n-1)}(t_0, t_1) + \lambda f_{(n)}(t_0, t_1)). \end{aligned}$$

C contains no line, so by Bézout there is, in addition to the point of intersection p of multiplicity $n - 1$ corresponding to $\lambda = 0$, another one corresponding to

$$\lambda = -\frac{f_{(n-1)}(t_0, t_1)}{f_{(n)}(t_0, t_1)}.$$

In particular, $f_{(n)}$ and $f_{(n-1)}$ have no common zeros. Hence the desired parametrization is given by

$$(t_0 : t_1) \mapsto (f_{(n)}(t_0, t_1) : -t_0 f_{(n-1)}(t_0, t_1) : -t_1 f_{(n-1)}(t_0, t_1)). \quad \square$$

Exercise. Give a rational parametrization of the three-leaf clover.

3.4. It is clear that the possible intersection multiplicities of two curves at a point depend on the orders of the curves. To make this more precise, we start by intersecting a curve with a line.

Let $f \in \mathbb{C}[X_1, X_2]$ be a minimal polynomial of $C = V(f)$, and let

$$f = \sum_{k=r}^n f_{(k)}, \quad \text{where } r = \text{ord}_0(f) \text{ and } n = \deg f,$$

be its Taylor expansion about $p = 0$. If the line L is parametrized by $\varphi(T) = (\lambda_1 T, \lambda_2 T)$, then

$$g(T) = f(\varphi(T)) = \sum_{k=r}^n f_{(k)}(\lambda_1, \lambda_2) T^k.$$

By Section 2.5, the intersection multiplicity is defined by

$$\text{mult}_p(C \cap L) = \text{ord}_p(g).$$

This is greater than r if and only if $f_{(r)}(\lambda_1, \lambda_2) = 0$. We have proved the following result.

Proposition. *If $C \subset \mathbb{C}^2$ is an algebraic curve and L is a line through $p \in C$, then*

$$\text{ord}_p(C) \leq \text{mult}_p(C \cap L),$$

and the inequality is strict for at most $\text{ord}_p(C)$ lines through p .

To avoid splitting the definition into cases, we set $\text{mult}_p(C \cap L) := \infty$ if $p \in L \subset C$. This allows us to define tangents to an algebraic curve at singular points as well.

Definition. As above, let $p \in C \cap L$. The line L is called a *tangent to C at p* if

$$\text{ord}_p(C) < \text{mult}_p(C \cap L).$$

If C is smooth at p , this definition agrees with the one given in Section 3.1. There is exactly one tangent in this case.

We call p an *ordinary r -fold point* if $r = \text{ord}_p(C)$ and there are r distinct tangents at p , i.e. if the homogeneous polynomial $f_{(r)}$ (in the expansion of the minimal polynomial of C about p) has r distinct zeros $(\lambda_1 : \lambda_2)$ in $\mathbb{P}_1(\mathbb{C})$. The latter give the slopes of the tangents.

When $p = 0$, the tangents can be described particularly simply: $f_{(r)}$ is the *initial polynomial* of f , and $V(f_{(r)})$ is the union of the tangents at 0 to the curve $C = V(f)$. Thus the tangents correspond to the “lowest-order part” of f .

Examples of points that are not ordinary are the cusp of the cuspidal cubic (Section 0.3) and the origin in the case of the ovoid (Section 3.3). In each of these examples there is only one tangent,

which must be counted twice and three times, respectively. The four-leaf clover (Section 3.3) has two tangents at the origin, each of which must be counted twice.

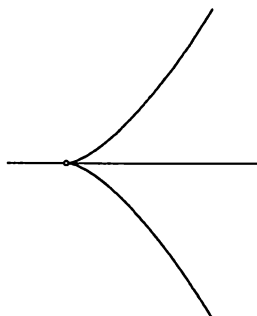

Figure 3.6. The cuspidal tangent of the cuspidal cubic

If $p \in C \subset \mathbb{C}^2$ is a smooth point and T is the tangent through p , then

$$k := \text{mult}_p(C \cap T)$$

is also called the *order of contact*; $2 \leq k \leq \infty$. A special choice of coordinates gives a useful form of the equation of C .

Lemma. *Let $C = V(f) \subset \mathbb{C}^2$ be smooth at $p = (0, 0)$, with tangent $T = V(X_2)$. If $k = \text{mult}_p(C \cap T) < \infty$, then*

$$f(X_1, X_2) = X_1^k g(X_1) + X_2 h(X_1, X_2),$$

where $g(0) \neq 0$ and $h(0, 0) \neq 0$.

Proof. The statement follows easily from the Taylor expansion of f about $(0, 0)$. □

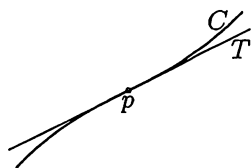

Figure 3.7. Inflectional tangent

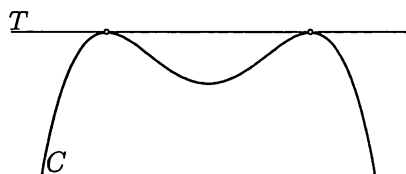

Figure 3.8. Bitangent

Fig. 42.

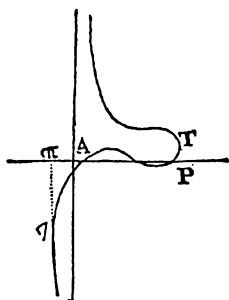

Fig. 53.

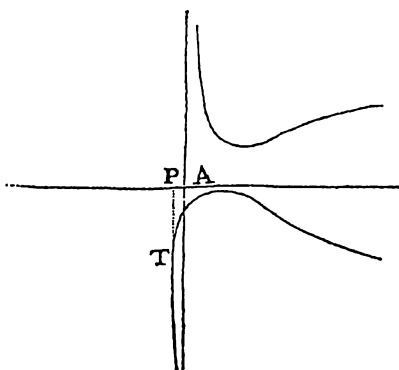

Fig. 8.

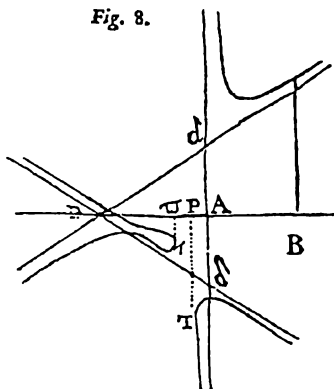

Fig. 20.

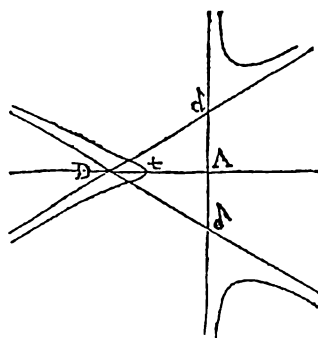

Figure 3.9. Four cubics from Newton's collection

Definition. If T is the tangent to C at a smooth point, then T is called

a *simple tangent*, if $\text{mult}_p(C \cap T) = 2$;

an *inflectional tangent*, if $\text{mult}_p(C \cap T) \geq 3$.

In the second case, p is called an *inflection point*. The case $T \subset C$, where $\text{mult}_p(C \cap T) = \infty$, is excluded to be on the safe side.

An inflection point p is called *simple* if $\text{mult}_p(C \cap T) = 3$. In contrast, we require that a *bitangent* be tangent at two or more distinct smooth points of C .

Quadrics cannot have inflection points; for cubics, at most three can be seen over the real numbers. In Figure 3.9 we reproduce four figures from Newton's collection [Ne]. Note that there is an inflection point at infinity in the last figure.

3.5. Calculations become significantly more complicated when we intersect a curve with another curve rather than with a line. We can prove the following result by local methods (see Section 8.6).

Theorem. Let $C_1, C_2 \subset \mathbb{C}^2$ be algebraic curves that have no common component. Then

$$\text{mult}_p(C_1 \cap C_2) \geq \text{ord}_p(C_1) \cdot \text{ord}_p(C_2)$$

for $p \in C_1 \cap C_2$. Equality holds if and only if C_1 and C_2 do not have a common tangent at p .

In many cases this lets us compute, or at least estimate, the intersection multiplicity without using the resultant. As an example, recall the two cuspidal cubics in Section 2.7, where $\text{ord}_p(C_i) = 2$ but $\text{mult}_p(C_1 \cap C_2) = 6 > 2 \cdot 2$.

Here is another example.

Example. If $C_1 = V(X_1)$ and $C_n = V(X_2^n + X_0^{n-1}X_1)$, then

$$\text{mult}_p(C_1 \cap C_n) = n$$

for $n \geq 2$ and $p = (1 : 0 : 0)$. In contrast, if we take the cubic $C = V(X_2^3 + X_0X_1^2)$, with cuspidal tangent $V(X_1)$ at p , and C_n as

before, then

$$\text{mult}_p(C \cap C_n) = 3,$$

which is independent of n . To prove this, set

$$\begin{aligned} F &= X_2^3 + a, & \text{where } a &= X_0 X_1^2; \\ F_n &= X_2^n + b, & \text{where } b &= X_0^{n-1} X_1. \end{aligned}$$

After computing an $(n+3) \times (n+3)$ determinant, we get

$$R_n = X_1^3 Q_n(X_0, X_1), \quad \text{where } Q_n(1, 0) \neq 0,$$

as the resultant of F and F_n for $n \geq 2$. Thus the contact of C_n with the cuspidal tangent does not increase the intersection multiplicity with the cubic. This shows how hard it is to understand the intersection multiplicity geometrically at a singular point where there are common tangents. In Chapter 5 this example will contribute to our understanding of the Plücker formulas.

3.6. To be able to apply the global statement of Bézout's theorem, we have to pass to projective space again and homogenize the polynomials that occur. Everything goes smoothly with the help of the following formula.

Euler's formula. *If $F \in \mathbb{C}[X_0, X_1, X_2]$ is homogeneous of degree n , then*

$$X_0 \frac{\partial F}{\partial X_0} + X_1 \frac{\partial F}{\partial X_1} + X_2 \frac{\partial F}{\partial X_2} = n \cdot F.$$

This can be checked directly, and is valid for arbitrarily many variables and over any field of characteristic zero. It gives the following result.

Proposition. *Let $C = V(F) \subset \mathbb{P}_2(\mathbb{C})$ be an algebraic curve, where F is a minimal polynomial, and let $p \in C$. Then*

a) C is smooth at p if and only if

$$\text{grad}_p F := \left(\frac{\partial F}{\partial X_0}(p), \frac{\partial F}{\partial X_1}(p), \frac{\partial F}{\partial X_2}(p) \right) \neq (0, 0, 0);$$

b) if C is smooth at p , then the projective tangent $T_p C$ at p is given by the linear equation

$$X_0 \frac{\partial F}{\partial X_0}(p) + X_1 \frac{\partial F}{\partial X_1}(p) + X_2 \frac{\partial F}{\partial X_2}(p) = 0.$$

Proof. If $p = (p_0 : p_1 : p_2)$, we may assume without loss of generality that $p_0 \neq 0$. An affine part of C that contains p is then described by $f(X_1, X_2) = F(1, X_1, X_2)$ (see Section 2.3), and we have

$$\frac{\partial f}{\partial X_i}(X_1, X_2) = \frac{\partial F}{\partial X_i}(1, X_1, X_2) \quad \text{for } i = 1, 2.$$

Thus $\text{grad}_p f \neq 0$ implies that $\text{grad}_p F \neq 0$. Conversely, if $\text{grad}_p f = 0$, then it follows from Euler's formula

$$0 = nF(p) = p_0 \frac{\partial F}{\partial X_0}(p)$$

that $\text{grad}_p F = 0$. This proves (a). By 3.1, the line given in (b) has the right slope, and by Euler it passes through p . \square

Our next result follows from this and the proposition in Section 3.2.

Corollary. *An algebraic curve $C \subset \mathbb{P}_2(\mathbb{C})$ has only finitely many singularities.*

Example. The Fermat curve $V(X_0^n - X_1^n - X_2^n) \subset \mathbb{P}_2(\mathbb{C})$ is irreducible (by Section 2.4 and Eisenstein) and smooth for every $n \geq 1$.

It can be proved that for "almost all" homogeneous polynomials $F \in \mathbb{C}[X_0, X_1, X_2]$ of degree n , the curve $V(F) \subset \mathbb{P}_2(\mathbb{C})$ is irreducible and smooth. So we could deal only with such curves—but, as happens so often, the exceptions are particularly attractive.

The definition of tangents at a singular point given in Section 3.4, in terms of the zeros of the *initial polynomial* $f_{(r)}$, is not immediately obvious geometrically. It takes some effort to understand its connection with tangents at smooth points. We use the notation above.

If $p \in C$ is a smooth point, then the coefficients in the equation for the tangent are given by

$$a_i = \frac{\partial F}{\partial X_i}(p) \quad \text{for } i = 0, 1, 2.$$

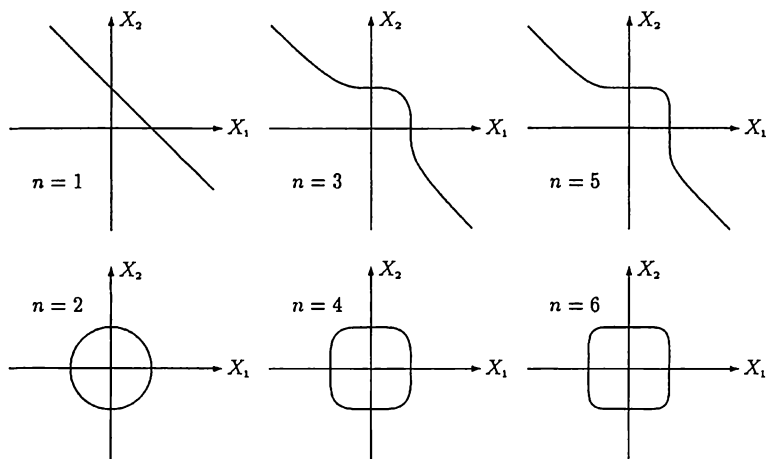

Figure 3.10. Fermat curves

They are unique only up to a nonzero factor, so we can identify the tangent with $(a_0 : a_1 : a_2)$; this is a point in the dual projective space $\mathbb{P}_2^*(\mathbb{C})$ (see [Fi], 3.4). $\mathbb{P}_2^*(\mathbb{C})$, like $\mathbb{P}_2(\mathbb{C})$, has a topology; thus we can say when a sequence of lines converges. This allows us to formulate the following theorem.

Theorem. *Let $p \in C \subset \mathbb{P}_2(\mathbb{C})$, and let $L \subset \mathbb{P}_2(\mathbb{C})$ be a line. L is a tangent to C at p if and only if there is a sequence of smooth points $p_\nu \in C$ converging to p such that*

$$L = \lim_{\nu \rightarrow \infty} T_{p_\nu} C.$$

The *proof* is postponed until Section 8.2.

3.7. To estimate the number of singularities, we use a “construction” of algebraic curves through prescribed points. Exactly one line passes through two points, and exactly one quadric through five non-collinear points. In the general case, looking for a polynomial is easier than looking for a curve.

We denote by $V_{n,k} \subset \mathbb{C}[X_0, \dots, X_k]$ the vector space of homogeneous polynomials of degree n in $k+1$ indeterminates. It is quite easy

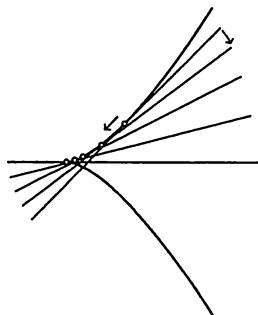

Figure 3.11. Convergence of tangents

to prove by induction on k that

$$\dim V_{k,n} = \binom{n+k}{n}.$$

Two polynomials in $V_{k,n}$ will be called equivalent if they differ only by a factor in \mathbb{C}^* . For $k = 2$, such an equivalence class corresponds geometrically to an effective divisor of degree n in $\mathbb{P}_2(\mathbb{C})$ (see Section 1.6); its support is a curve of degree $\leq n$. The set of these equivalence classes is a projective space $\mathbb{P}_N(\mathbb{C})$, where $N = \binom{n+k}{n} - 1$. Now let

$$F = \sum_{\nu_0+\nu_1+\nu_2=n} a_{\nu_0\nu_1\nu_2} X_0^{\nu_0} X_1^{\nu_1} X_2^{\nu_2} \quad \text{and} \quad p = (p_0 : p_1 : p_2) \in \mathbb{P}_2(\mathbb{C}).$$

The condition $p \in V(F)$ means that $F(p_0, p_1, p_2) = 0$; this is a linear condition on the $N + 1$ coefficients $a_{\nu_0\nu_1\nu_2}$ of F , i.e. on the homogeneous coordinates in $\mathbb{P}_N(\mathbb{C})$. Thus every point in $\mathbb{P}_2(\mathbb{C})$ through which the “curve” is to pass determines a hyperplane in $\mathbb{P}_N(\mathbb{C})$. The intersection of N hyperplanes contains at least one point in $\mathbb{P}_N(\mathbb{C})$ (that is, an equivalence class of polynomials). Points $P_1, \dots, P_N \in \mathbb{P}_2(\mathbb{C})$ are said to be in *general position* (with respect to curves of degree n) if the hyperplanes they determine in $\mathbb{P}_N(\mathbb{C})$ intersect in exactly one point. Together with the formula

$$\binom{n+2}{n} - 1 = \frac{1}{2}n(n+3),$$

this leads to the following lemma.

Lemma. *Through $\frac{1}{2}n(n+3)$ points in $\mathbb{P}_2(\mathbb{C})$ there passes at least one algebraic curve of degree $\leq n$. A more precise result holds: If the points are in general position, then there is exactly one effective divisor of degree n on whose support the points lie.*

3.8. In the plane, n lines can intersect in $\frac{1}{2}n(n-1)$ points. Thus an algebraic curve of degree n can have $\frac{1}{2}n(n-1)$ singularities. There is a better bound for irreducible curves.

Theorem. *An irreducible algebraic curve $C \subset \mathbb{P}_2(\mathbb{C})$ of degree n has at most*

$$\gamma(n) := \frac{1}{2}(n-1)(n-2)$$

singularities.

That $\gamma(1) = \gamma(2) = 0$ is known from elementary geometry. $\gamma(3) = 1$ corresponds to the observation that an irreducible cubic can have at most a cusp or an ordinary double point. $\gamma(4) = 3$ is attained by the hypocycloid in Section 0.6.

For the *proof of the theorem*, we may assume that $n \geq 3$. Suppose there were $\gamma(n) + 1$ singularities on C . We adjoin $n - 3$ more points to C , so altogether there are

$$\gamma(n) + 1 + n - 3 = \frac{1}{2}(n-2)(n+1)$$

points. By Section 3.7 there is a curve C' of degree $m \leq n - 2$ that passes through all these points. For each singular point p of C we have $\text{mult}_p(C \cap C') \geq 2$, and for each of the $n - 3$ additional points $\text{mult}_p(C \cap C') \geq 1$, so

$$\sum_{p \in C \cap C'} \text{mult}_p(C \cap C') \geq 2(\gamma(n) + 1) + n - 3 = n(n-2) + 1.$$

C is irreducible and $\deg C' < n$, so C cannot be a component of C' . Bézout's theorem gives

$$\sum_{p \in C \cap C'} \text{mult}_p(C \cap C') = n \cdot m \leq n(n-2),$$

contradicting the inequality above. □

Corollary. *An arbitrary algebraic curve of degree n in $\mathbb{P}_2(\mathbb{C})$ has at most $\frac{1}{2}n(n-1)$ singularities.*

This follows from the theorem above, by induction on the number of components.

For a more accurate count, one can assign weights to the singularities and show that

$$\sum_{p \in \text{Sing } C} \text{ord}_p C (\text{ord}_p C - 1) \leq (n-1)(n-2)$$

if C is irreducible (see Sections 9.9 and A.5.5).

In Chapter 9 we will show what the number $\gamma(n)$ introduced in the theorem has to do with the *genus* of the curve.

3.9. It is a very natural question to ask whether, for each n , there exist irreducible curves of degree n in $\mathbb{P}_2(\mathbb{C})$ that have the maximal number $\gamma(n) = \frac{1}{2}(n-1)(n-2)$ of singularities. In [S, Anhang F], Severi showed that there even exist irreducible curves in $\mathbb{P}_2(\mathbb{C})$ with exactly d ordinary double points for $0 \leq d \leq \gamma(n)$, and no other singularities. But he did not give explicit examples.

From the real point of view, it is highly desirable to be able to see and count these points. So I was very happy when I found a construction, first published in 1993 [P], which gave a “real” and explicit solution to this problem. I think it is worthwhile to reproduce it here in detail.

First we fix the notation

$$I := (-1, 1) \subset \mathbb{R} \quad \text{and} \quad \bar{I} := [-1, 1] \subset \mathbb{R},$$

and recall some elementary facts about the *Chebyshev polynomials* T_n , which are standard tools in approximation theory. Their origin is the trigonometric formulas

$$\cos(n\varphi) = T_n(\cos \varphi) \quad \text{for } n \in \mathbb{N},$$

where the polynomials T_n are defined recursively by

$$T_0(t) := 1, \quad T_1(t) := t, \quad T_{n+1}(t) := 2tT_n(t) - T_{n-1}(t).$$

Then obviously $\deg T_n = n$, $T_n(1) = 1$, $T_n(-1) = (-1)^n$. Considered as real functions, Chebyshev polynomials look almost like trigonometric functions on I , and they go directly to infinity outside I ; see Figure 3.12.

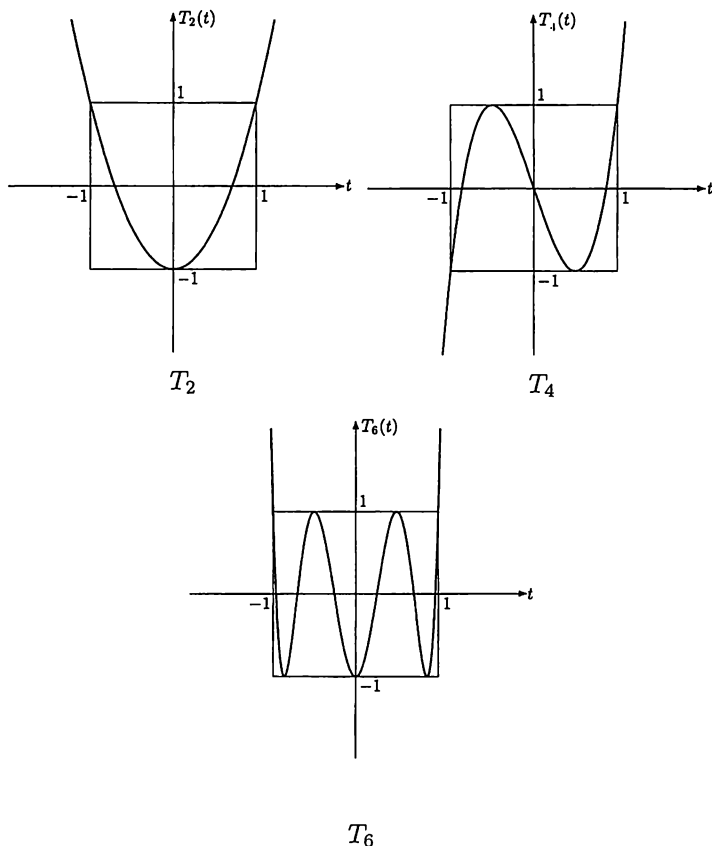

Figure 3.12

Their behavior on \bar{I} follows from the formula

$$T_n(t) = \cos(n \arccos t) \quad \text{for } t \in \bar{I}.$$

In particular,

$$\begin{aligned} T_n(t) = 0 &\Leftrightarrow n \arccos t = \frac{2k-1}{2}\pi \\ &\Leftrightarrow t = \cos \frac{2k-1}{2n}\pi \quad \text{for some } k \in \mathbb{Z}. \end{aligned}$$

For $k = 1, \dots, n$ we obtain n distinct zeros of T_n in I . The derivative is given by

$$\dot{T}_n(t) = \frac{n}{\sqrt{1-t^2}} \sin(n \arccos t).$$

So, for $t \in I$, we have

$$\dot{T}_n(t) = 0 \Leftrightarrow n \arccos t = k\pi \Leftrightarrow t = \cos \frac{k}{n}\pi \quad \text{for some } k \in \mathbb{Z}.$$

For $k = 1, \dots, n-1$ this yields $n-1$ distinct zeros of \dot{T}_n in I , hence $n-1$ local maxima or minima of T_n . Since $\deg \dot{T}_n = n-1$ there are no other zeros.

Physically, *Lissajous curves* are the traces of a double pendulum with two different frequencies in orthogonal directions. Mathematically, in their simplest form, they can be parametrized by

$$\mathbb{R} \longrightarrow \mathbb{R}^2, \quad t \mapsto (\cos mt, -\cos n(t + \omega)),$$

where m, n are positive integers and $\omega \in \mathbb{R}$ is a “phase shift.” They always stay in the square $\bar{I} \times \bar{I}$ and are periodic. Since $\cos mt$ and $\sin nt$ satisfy an algebraic relation, they are even algebraic, and they have many ordinary double points (see [B-K]). But computing the degree and the number of double points is not so easy.

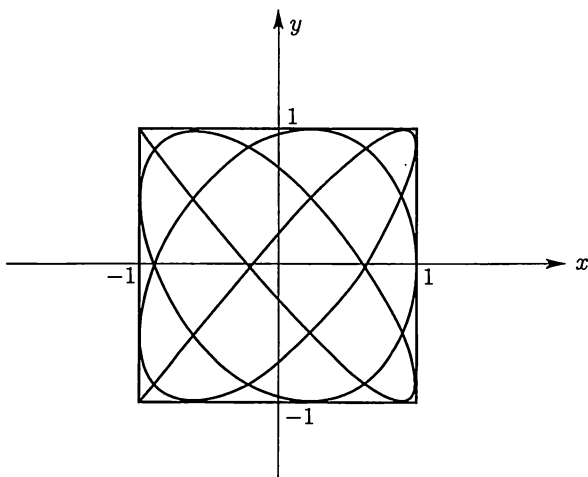

Figure 3.13. Lissajous curve

D. Pecker [P] gave a clever variation and simplification by using Chebyshev polynomials instead of trigonometric functions. The result is curves that jump in from infinity, flip around briefly in the square $\bar{I} \times \bar{I}$ like Lissajous curves, then rush back to infinity. But such a curve has many more double points than a Lissajous curve of the same degree.

To make this precise we consider the map

$$\varphi_{m,n} : \mathbb{R} \longrightarrow \mathbb{R}^2, \quad t \mapsto (T_m(t), T_n(t)),$$

and its extension

$$\bar{\varphi}_{m,n} : \mathbb{C} \longrightarrow \mathbb{C}^2, \quad t \mapsto (T_m(t), T_n(t)),$$

where m, n are positive integers. The images

$$C_{m,n} := \varphi_{m,n}(\mathbb{R}) \subset \mathbb{R}^2 \quad \text{and} \quad \bar{C}_{m,n} = \bar{\varphi}_{m,n}(\mathbb{C}) \subset \mathbb{C}^2,$$

are called (real and complex) *Chebyshev curves*.

Theorem. *If m, n are relatively prime and $m < n$, then the Chebyshev curves have the following properties:*

- a) $\bar{C}_{m,n} = \{(x, y) \in \mathbb{C}^2 : T_n(x) = T_m(y)\}$.
- b) $\bar{C}_{m,n} \subset \mathbb{C}^2$ is algebraic of degree n and irreducible.
- c) $\bar{C}_{m,n}$ has $\frac{1}{2}(m-1)(n-1)$ ordinary double points.
- d) All ordinary double points of $\bar{C}_{m,n}$ are real and lie in $I \times I \subset \mathbb{R}^2$. They are also ordinary double points of the real curve $C_{m,n}$.

In addition, the existence of the parametrization $\bar{\varphi}_{m,n}$ implies that the closure of $\bar{C}_{m,n}$ in $\mathbb{P}_2(\mathbb{C})$ is rational (see Section 9.3).

The most interesting case is $m = n - 1$ (see Section 3.8):

Corollary. *The Chebyshev curve $\bar{C}_{n-1,n} \subset \mathbb{C}^2$ of degree n has the maximal number*

$$\frac{1}{2}(n-1)(n-2)$$

of singularities. They are all ordinary double points and real.

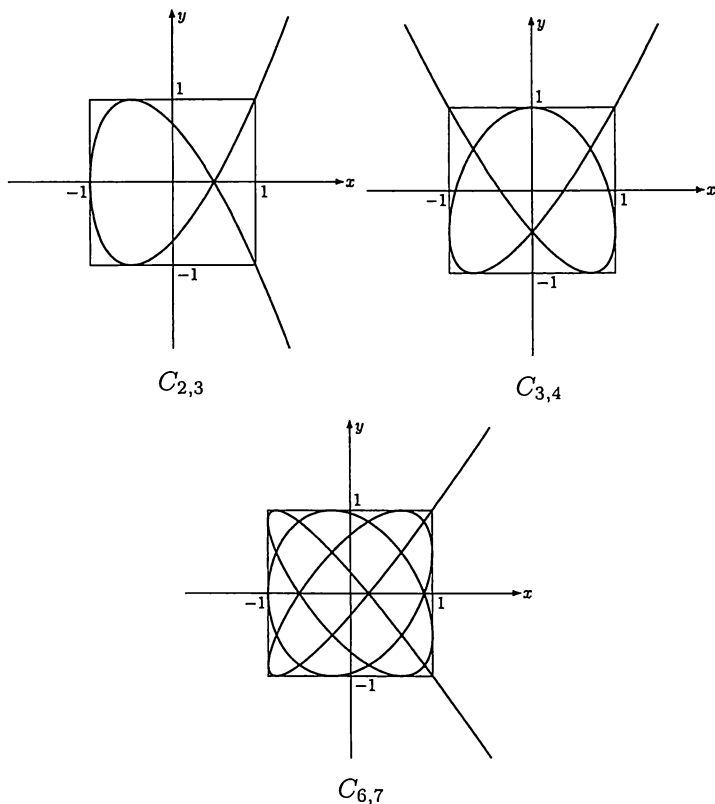

Figure 3.14

We don't investigate the case where m and n have a common divisor. We only mention that $T_n(x) - T_m(y)$ will be reducible in general.

For instance,

$$T_4(x) - T_2(y) = 2(T_2(x) + T_1(y))(T_2(x) - T_1(y)).$$

For the *proof of the theorem* we use the following real lemma.

Lemma. *If $m, n \in \mathbb{N}$ are relatively prime, then the restriction*

$$\varphi'_{m,n} : \bar{I} \longrightarrow \{(x, y) \in \bar{I} \times \bar{I} : T_n(x) = T_m(y)\}$$

of $\varphi_{m,n}$ is surjective.

General identity theorems for analytic functions show that this result extends from \bar{I} to \mathbb{R} and to \mathbb{C} . This is assertion (a). Hence $\bar{C}_{m,n}$ is algebraic. As the image of \mathbb{C} it is irreducible, and $\deg \bar{C}_{m,n} \leq n$ since the given equation has degree n . But a look at the zeros of the Chebyshev polynomials shows that $C_{m,n}$ intersects a line $x = c$ with $c \in I$ in n points. Hence $\deg \bar{C}_{m,n} \geq n$.

As a consequence, we see that the polynomial

$$T_n(x) - T_m(y) \in \mathbb{C}[x, y]$$

is irreducible for m, n relatively prime. The reader may try to give a direct proof of this fact.

To prove (c) and (d), we begin by counting singularities. $\bar{C}_{m,n}$ is singular in $(x, y) \in \mathbb{C}^2$ if and only if

$$T_n(x) - T_m(y) = 0 \quad \text{and} \quad \text{grad}_{(x,y)}(T_n(x) - T_m(y)) = (0, 0).$$

In $I \times I$ this means that

$$\begin{aligned} \cos(n \arccos x) &= \cos(m \arccos y) \quad \text{and} \\ \sin(n \arccos x) &= \sin(m \arccos y) = 0. \end{aligned}$$

The second pair of conditions means that

$$\begin{aligned} x &= \cos \frac{k}{n} \pi \quad \text{for } k = 1, \dots, n-1, \\ y &= \cos \frac{l}{m} \pi \quad \text{for } l = 1, \dots, m-1, \end{aligned}$$

so there are $(m-1)(n-1)$ possibilities for $(x, y) \in I \times I$. The first condition yields

$$\cos(k\pi) = \cos(l\pi).$$

Hence $k - l$ must be even. A simple counting argument shows that

$$\frac{1}{2} (m-1)(n-1)$$

pairs (k, l) are left. Hence there are $\frac{1}{2} (m-1)(n-1)$ singular points $(x, y) \in C_{m,n}$ in $I \times I$.

It should be noted that there might be additional singularities outside $I \times I$. Because of the bound given in Section 3.8, this is impossible in the case $m = n - 1$.

In order to prove that the singularities are ordinary double points, we have to look at the quadratic part $f_{(2)}$ of $f(x, y) = T_n(x) - T_m(y)$ at the singular point (x_0, y_0) , i.e. the Hessian. It is obvious that the mixed partials vanish. Now suppose that

$$x_0 = \cos \frac{k}{n} \pi, \quad \text{with } k \in \{1, \dots, n-1\},$$

$$y_0 = \cos \frac{l}{m} \pi, \quad \text{with } l \in \{1, \dots, m-1\},$$

and $k - l$ is even. After some computations we obtain

$$\frac{\partial^2 f}{\partial x^2}(x_0, y_0) = (-\cos k\pi) \cdot \alpha,$$

$$\frac{\partial^2 f}{\partial y^2}(x_0, y_0) = (\cos l\pi) \cdot \beta,$$

with $\alpha, \beta > 0$. Thus the Hessian of f at (x_0, y_0) is indefinite, and f does not have a local extremum at (x_0, y_0) . In particular, not only the complex curve $\overline{C}_{m,n}$ but also the real curve $C_{m,n}$ has two “branches” with distinct tangents at (x_0, y_0) . This can also be seen directly: from α, β we obtain $\lambda, \mu > 0$ such that

$$\begin{aligned} \pm f_{(2)} &= \lambda^2(x - x_0)^2 - \mu^2(y - y_0)^2 \\ &= (\lambda(x - x_0) + \mu(y - y_0))(\lambda(x - x_0) - \mu(y - y_0)). \end{aligned}$$

These two real linear factors describe the two tangents in \mathbb{R}^2 and \mathbb{C}^2 . □

Finally, we have to give a *proof of the lemma*.

Proof. A trivial computation shows that

$$T_n(T_m(t)) = T_{nm}(t) = T_m(T_n(t))$$

for arbitrary $n, m \in \mathbb{N}$ and $t \in \mathbb{R}$. So the image of $\varphi'_{m,n}$ satisfies the given equation.

For the proof of surjectivity we simplify notation by using the transformation

$$\arccos : \overline{I} \longrightarrow J = [0, \pi].$$

Then we have to show the following “Chinese remainder” result: If $\alpha, \beta \in J$ satisfy the equation

$$\cos m\alpha = \cos n\beta, \quad (*)$$

then there is a $\gamma \in J$ such that

$$\cos \alpha = \cos n\gamma \quad \text{and} \quad \cos \beta = \cos m\gamma.$$

Condition (*) implies that $m\alpha \pm n\beta = 2\pi r$ for some $r \in \mathbb{Z}$. Since m, n are relatively prime, there are $k, l \in \mathbb{Z}$ such that

$$r = km + ln; \quad \text{hence } m\alpha \pm n\beta = 2\pi(km + ln).$$

If we define

$$\gamma' := \frac{\pm\beta - 2\pi l}{m} = \frac{-\alpha + 2\pi k}{n} \in \mathbb{R}$$

and $\gamma \in J$ such that $\cos \gamma' = \cos \gamma$, then

$$\cos n\gamma = \cos n\gamma' = \cos(-\alpha) = \cos \alpha \quad \text{and}$$

$$\cos m\gamma = \cos m\gamma' = \cos(\pm\beta) = \cos \beta. \quad \square$$

The curves $\overline{C}_{n-1, n}$ can be modified by standard methods to curves with exactly d ordinary double points for $0 \leq d \leq \frac{1}{2}(n-1)(n-2)$, all real, and no other singularities (see [P]).

Polars and Hessian Curves

In this chapter we consider the following questions about an algebraic curve $C \subset \mathbb{P}_2(\mathbb{C})$:

- a) How can we find the tangents to C that pass through a prescribed point q ?
- b) How can we find the inflection points of C ?

To answer these questions, we will intersect the given curve with other suitable curves (polars and Hessian curves). Bézout's theorem then allows us to make statements about the number of tangents and inflection points.

4.1. We turn first to the tangents. Let $C = V(F) \subset \mathbb{P}_2(\mathbb{C})$, with F minimal, and let $p \in C$ be a smooth point. According to Section 3.6, the equation of the tangent $T_p C$ at p is given by

$$\sum_{i=0}^2 X_i \frac{\partial F}{\partial X_i}(p) = 0.$$

Thus an arbitrary point $q = (q_0 : q_1 : q_2) \in \mathbb{P}_2(\mathbb{C})$ lies on $T_p C$ if and only if

$$\sum_i q_i \frac{\partial F}{\partial X_i}(p) = 0, \quad \text{i.e.} \quad p \in V\left(\sum_i q_i \frac{\partial F}{\partial X_i}\right).$$

This motivates the definition.

Definition. Let $C \subset \mathbb{P}_2(\mathbb{C})$ be an algebraic curve with minimal polynomial F of degree ≥ 2 . Let $q = (q_0 : q_1 : q_2) \in \mathbb{P}_2(\mathbb{C})$ be arbitrary and

$$D_q F := q_0 \frac{\partial F}{\partial X_0} + q_1 \frac{\partial F}{\partial X_1} + q_2 \frac{\partial F}{\partial X_2}.$$

If $\deg D_q F \geq 1$, then $P_q C := V(D_q F)$ is called the *polar* of C with respect to the *pole* q .

First, a few examples.

Examples.

a) Let $F = X_1 X_2$. For $q = (1 : 0 : 0)$, we have $D_q F = 0$; the polar is undefined. For $q = (\lambda : 1 : 0)$, we have $D_q F = X_2$; the polar is a component of the curve. These are the pathological cases.

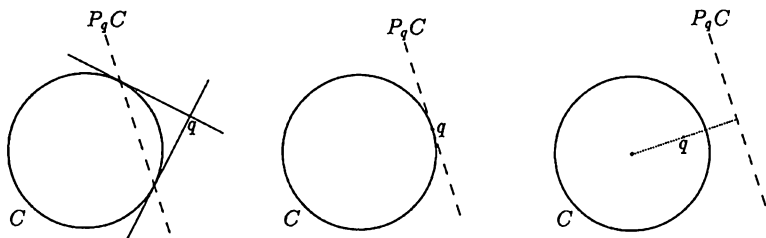

Figure 4.1. The polars of a circle

b) Let C be a smooth quadric. Then $P_q C$ is a line, the classical polar.

c) Let C be a cuspidal cubic with $F = X_2^3 + X_0 X_1^2$. Then

$$D_q F = q_0 X_1^2 + 2q_1 X_0 X_1 + 3q_2 X_2^2.$$

At the point $p = (1 : 0 : 0)$, C has the cuspidal tangent $T = V(X_1)$. If q lies on T , then the polar $P_q C$ consists of two lines through p , and $\text{mult}_p(C \cap P_q C) = 4$.

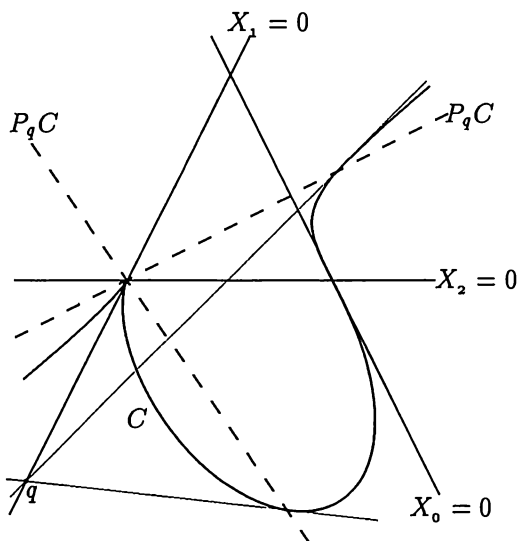

Figure 4.2. Polar to the cuspidal cubic, for a pole on the line $V(X_1)$

Otherwise $q_1 \neq 0$. If $q_2 = 0$, then $P_q C$ consists of the cuspidal tangent T and another line through $(0 : 0 : 1)$. (See Figure 4.3.) So the intersection multiplicity is

$$\text{mult}_p(C \cap P_q C) = 3.$$

According to Section 2.7, we have to compute a resultant in order to show that this also holds for $q_2 \neq 0$. We may assume that $3q_2 = 1$. Then

$$F = X_2^3 + a, \quad \text{where } a = X_0 X_1^2,$$

$$D_q F = X_2^2 + b, \quad \text{where } b = (q_0 X_1 + 2q_1 X_0) X_1 = \tilde{b}(X_0, X_1) \cdot X_1.$$

Thus $P_q C$ is a smooth quadric, with tangent $V(X_1)$ at p . (See Figure 4.4.) We have

$$R = \begin{vmatrix} 1 & 0 & 0 & a & 0 \\ 0 & 1 & 0 & 0 & a \\ 1 & 0 & b & 0 & 0 \\ 0 & 1 & 0 & b & 0 \\ 0 & 0 & 1 & 0 & b \end{vmatrix} = a^2 + b^3 = X_1^3 (X_0^2 X_1 + \tilde{b}^3).$$

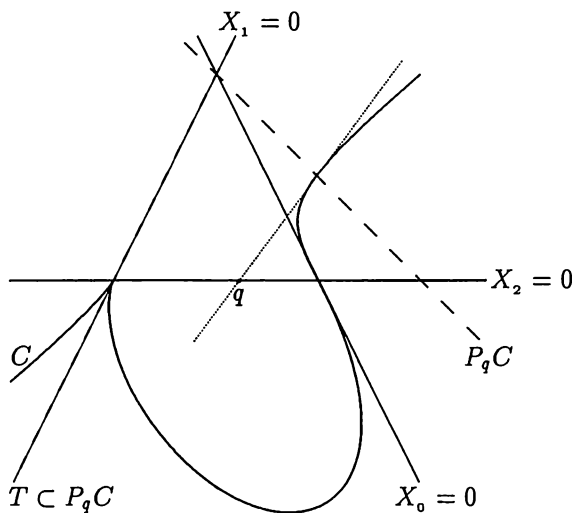

Figure 4.3. Polar to the cuspidal cubic, for a pole on the line $V(X_2)$

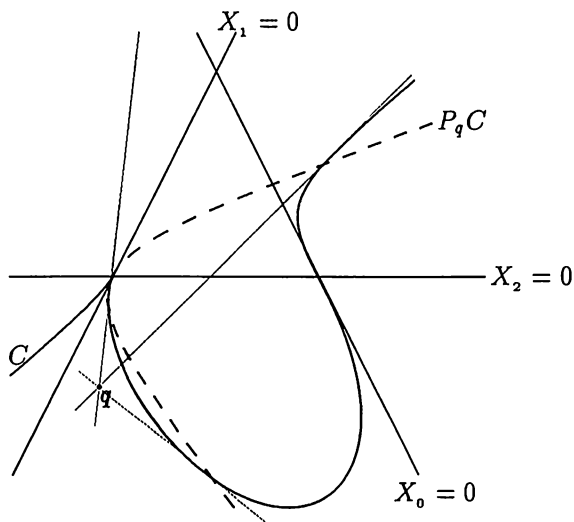

Figure 4.4. Polar to the cuspidal cubic, for a general pole

Here $\tilde{b}(1, 0) \neq 0$ because $q_1 \neq 0$. It follows that

$$\text{mult}_p(C \cap P_q C) = 3$$

if q does not lie on the cuspidal tangent $V(X_1)$.

d) For the folium of Descartes C with $F = X_1^3 + X_2^3 - 3X_0X_1X_2$, we have

$$\frac{1}{3}D_q F = -q_0X_1X_2 + q_1(X_1^2 - X_0X_2) + q_2(X_2^2 - X_0X_1).$$

Thus the polar of C with respect to $q = (1 : 0 : 0)$ is the union of the axes, $X_1X_2 = 0$. If $(q_1, q_2) \neq (0, 0)$, then $P_q C$ is a smooth quadric with the tangent

$$q_2X_1 + q_1X_2 = 0$$

at the double point $p = (1 : 0 : 0)$ of C . Thus (by Section 3.5, for instance)

$$\text{mult}_p(C \cap P_q C) = 2$$

if $q_1 \neq 0$ and $q_2 \neq 0$, i.e. if q does not lie on one of the two tangents to C at p .

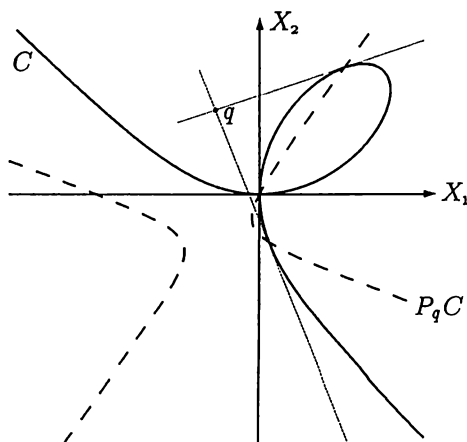

Figure 4.5. Polar to the folium of Descartes

4.2. The examples above already give clues about general properties of polars.

Proposition. *The following statements are true under the conditions of Definition 4.1. Here $n := \deg F$.*

- a) *The polar $P_q C$ is independent of the choice of coordinates.*
- b) *$D_q F = 0$ if and only if C consists of n lines through q .*
- c) *$\deg D_q F = n - 1$ whenever $D_q F \neq 0$.*
- d) *C and $P_q C$ have a common component if and only if C contains a line through q .*
- e) *If $p \in C$ is singular and $q \in \mathbb{P}_2(\mathbb{C})$ is arbitrary, then $p \in P_q C$.*

Proof. An elementary computation with linear transformations gives (a). Hence we can take $q = (1 : 0 : 0)$ in (b). Then $D_q F = 0$ means that F is independent of X_0 , so $f(X_1, X_2) = F(1, X_1, X_2)$ is homogeneous of degree n . In the notation of Section 3.3, this means that $f = f_{(n)}$. Statements (c) and (e) are clear; (d) requires an argument similar to that used to prove Proposition 3.2. \square

4.3. To summarize, we record our results as a theorem.

Theorem. *Let $C = V(F)$ be an algebraic curve of degree $n \geq 2$ that contains no lines, and let $q \in \mathbb{P}_2(\mathbb{C})$ be arbitrary. Then the polar $P_q C$ is an algebraic curve of degree $\leq n - 1$ that has no component in common with C . As an effective divisor, denoted by $D_q F$, it has degree $n - 1$. The intersection $C \cap P_q C$ consists of the points of tangency of the tangents to C through q , together with the singularities of C .*

In particular, by Bézout's theorem there are at most $n(n - 1)$ tangents to C through q . This number is reduced by bitangents, inflection points, and singularities. For a precise count of the points of intersection, we make the following observation.

Proposition. *Suppose the curve C has a simple tangent at p ; that is, $\text{mult}_p(T \cap C) = 2$. If $q \in T$ is distinct from p , then the polar $P_q C$ intersects C transversely at p , i.e.*

$$\text{mult}_p(C \cap P_q C) = 1.$$

In particular, the polar is smooth at p .

Proof. If $p = (1 : 0 : 0)$ and $T = V(X_2)$, then by Lemma 3.4

$$F = X_1^2 \cdot G(X_0, X_1) + X_2 \cdot H(X_0, X_1, X_2),$$

where

$$G(1, 0) \neq 0 \quad \text{and} \quad H(1, 0, 0) \neq 0.$$

If we use this to compute $D_q F$, and consider $q_1 \neq 0$ and $q_2 = 0$, the assertion follows. \square

The following corollary of the properties of polars proved above is often useful.

Corollary. *If C is an algebraic curve of degree n and $q \notin C$, then almost all the lines through q have exactly n simple intersection points with C .*

Proof. The polar $P_q C$ has only finitely many points of intersection with C . Every line through q that does not pass through $C \cap P_q C$ satisfies the condition above. \square

4.4. Now we turn to the second problem of this section, looking for inflection points (see Section 3.4) and estimating how many there are. It is obvious that we need second derivatives, but not at all clear how to use them to find the equation of a suitable algebraic curve.

Definition. If $F \in \mathbb{C}[X_0, X_1, X_2]$ is homogeneous of degree ≥ 2 , then the symmetric 3×3 matrix

$$H_F := \left(\frac{\partial^2 F}{\partial X_i \partial X_j} \right)_{0 \leq i, j \leq 2}$$

is called the *Hessian matrix* of F . If F is a minimal polynomial of a curve $C = V(F) \subset \mathbb{P}_2(\mathbb{C})$ and $\deg(\det H_F) \geq 1$, then $H(C) := V(\det H_F)$ is called the *Hessian curve* of C .

First, a few degenerate examples.

Examples.

a) Let $F = X_0^2 + X_1^2 + X_2^2$. Then $\det H_F = 8$, so $H(C) = \emptyset$.

b) Let $F = X_1 X_2 (X_1 - X_2)$. Then $\det H_F = 0$, so $H(C) = \mathbb{P}_2(\mathbb{C})$.

c) Let $F = X_0X_1X_2$. Then $\det H_F = 2F$, so $H(C) = C$.

d) Let $F = X_0(X_0^2 + X_1^2 + X_2^2)$. Then $\det H_F = 8X_0(3X_0^2 - X_1^2 - X_2^2)$, with corresponding decompositions

$$C = L \cup C_1, \quad H(C) = L \cup C_2.$$

(See Figure 4.6.) Here L is a line, C_1 and C_2 are quadrics, and $C_1 \cap C_2 = C_1 \cap L = C_2 \cap L$. In this case, C and $H(C)$ have a common component.

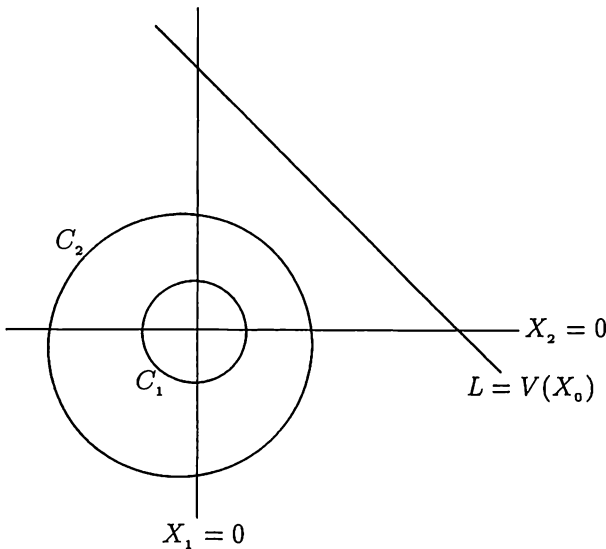

Figure 4.6. A degenerate case of the Hessian curve

The following lemma is useful for computations in affine coordinates.

Lemma. Let $F \in \mathbb{C}[X_0, X_1, X_2]$ be homogeneous of degree n and let $F_i = \partial F / \partial X_i$, $F_{ij} = \partial^2 F / \partial X_j \partial X_i$. Then

$$\det H_F = \frac{n-1}{X_0} \begin{vmatrix} F_0 & F_1 & F_2 \\ F_{01} & F_{11} & F_{21} \\ F_{02} & F_{12} & F_{22} \end{vmatrix} = \frac{n-1}{X_0^2} \begin{vmatrix} nF & F_1 & F_2 \\ (n-1)F_1 & F_{11} & F_{21} \\ (n-1)F_2 & F_{12} & F_{22} \end{vmatrix}.$$

Proof. The first equality follows from Euler's formula (Section 3.6) applied to F_i , where the zeroth row is multiplied by X_0 , and the j th row is multiplied by X_j (for $j = 1, 2$) and added to it. A similar procedure with the columns gives the second equality. \square

Proposition. *With the notation above:*

- a) *The Hessian curve is independent of the coordinates.*
- b) $\deg(\det H_F) = 3(n - 2)$ if $\det H_F \neq 0$.
- c) $\text{Sing } C \subset H(C)$.

Proof. H_F transforms as a quadratic form, so $\det H_F$ is multiplied by $(\det A)^2 \neq 0$ under a change of coordinates given by $A \in \text{GL}(3, \mathbb{C})$. This proves (a). Assertion (b) is clear.

To prove (c), let $p = (p_0 : p_1 : p_2) \in C$ be singular and $p_0 \neq 0$. Since $F(p) = F_1(p) = F_2(p) = 0$, it follows from the lemma that $\det H_F(p) = 0$. \square

4.5. Our next theorem shows the significance of the Hessian curve $H(C)$.

Theorem. *Let $C = V(F) \subset \mathbb{P}_2(\mathbb{C})$ be a curve that contains no lines. Then*

- a) $\det H_F \neq 0$;
- b) *a smooth point $p \in C$ is an inflection point if and only if $p \in H(C)$;*
- c) *C and $H(C)$ have no common component;*
- d) *if $p \in C$ is a simple inflection point, then*

$$\text{mult}_p(C \cap H(C)) = 1.$$

Proof. Let $p = (1 : 0 : 0) \in C$ be smooth, with tangent $T = V(X_2)$. By Lemma 3.4 we can write $F(1, X_1, X_2)$ in the form

$$f = X_1^k g(X_1) + X_2 h(X_1, X_2),$$

where

$$X_1^k g = a_2 X_1^2 + a_3 X_1^3 + \cdots \quad \text{and} \quad h = b + b_1 X_1 + b_2 X_2 + \cdots.$$

Here $2 \leq k = \text{mult}_p(C \cap T) < \infty$; $b \neq 0$; and $a_2 = 0$ if and only if $k \geq 3$, i.e. if p is an inflection point. Using Lemma 4.4, we find that

$$\det H_F(p) = (n-1)^2 \begin{vmatrix} 0 & 0 & b \\ 0 & 2a_2 & b_1 \\ b & b_1 & 2b_2 \end{vmatrix} = -2(n-1)^2 b^2 a_2.$$

This immediately gives (b). To prove (a), it suffices to show that there exists a smooth point p that is not an inflection point. This follows from (for instance) the implicit function theorem (Section 6.9).

To prove (c) we have to patiently track down the lowest-order terms of the Taylor expansion of $\det H_F$ about p . We get

$$\det H_F = X_1^{k-2} \tilde{G}(X_0, X_1) + X_2 \cdot \tilde{H}(X_0, X_1, X_2),$$

where $\tilde{G}(1, 0) \neq 0$. This implies (c) because it follows from the inequality $\text{mult}_p(H(C) \cap T) < k$ that C and $H(C)$ cannot have a common component at a smooth point.

For $k = 3$, $H(C)$ is smooth at p , with a tangent distinct from T . This gives (d). \square

Bézout's theorem for $C \cap H(C)$ yields a corollary.

Corollary. *An algebraic curve $C \subset \mathbb{P}_2(\mathbb{C})$ of degree $n \geq 2$ that contains no lines has at most $3n(n-2)$ inflection points.*

Now we can also use the preceding arguments to see when the Hessian curve degenerates.

Proposition. *$C \subset H(C)$ if and only if C is a union of lines. More precisely:*

- a) *If C contains a line L , then $L \subset H(C)$.*
- b) *Let $C' \subset C$ be an irreducible component with $C' \subset H(C)$. Then C' is a line.*

Proof. a) Let $C = V(F)$, $L = V(X_0)$, and $F = X_0 G$. Then $F_i = X_0 G_i$ and $F_{ij} = X_0 G_{ij}$ for $i, j = 1, 2$. By Lemma 4.4,

$$X_0^2 \cdot \det H_F = X_0^3 \cdot \Delta; \quad \det H_F = X_0 \cdot \Delta.$$

Here Δ is the determinant of a matrix that contains G , G_i , and G_{ij} .

b) It must be shown that a component $C' \subset C$ that is not a line cannot be a component of $H(C)$. To do this, choose a point p at which C and C' are smooth and proceed as in the proof of (c) in Theorem 4.5. \square

4.6. The maximum number of inflection points is attained only if C has no singularities and all its inflection points are simple. Here are a few examples.

Examples.

a) If $F = X_0^3 + X_1^3 + X_2^3$, then the Fermat cubic $C = V(F)$ is smooth and $\det H_F = 6^3 X_0 X_1 X_2$, so $H(C)$ splits into three lines. On $X_0 = 0$ there are three inflection points,

$$(0 : 1 : -1), \quad (0 : \zeta : -1), \quad (0 : \zeta^2 : -1),$$

where ζ is a primitive cube root of unity. There are also three inflection points on each of the lines $X_1 = 0$ and $X_2 = 0$, so there are nine altogether. Three of them are real: $(0 : 1 : -1)$, $(1 : 0 : -1)$, and $(1 : -1 : 0)$.

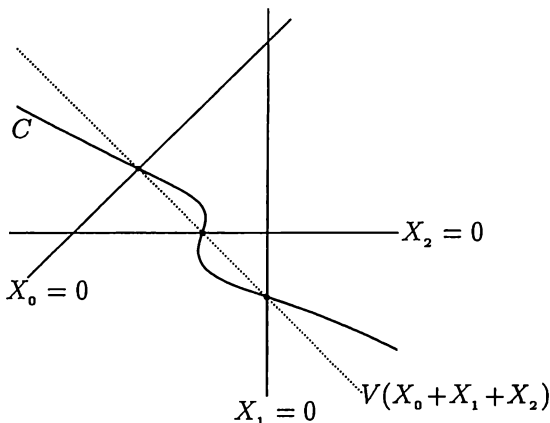

Figure 4.7. The Fermat cubic with its three real inflection points

This is the point of departure for the classification of cubics and the theory of elliptic functions at the time of Hesse and Weierstrass. It turns out that every smooth cubic has exactly three real inflection

points and that these inflection points always lie on a line (see for instance [B-K], 7.3).

b) If $F = X_1^3 - X_0X_2^2$, then for the cuspidal cubic $C = V(F)$ we have $\det H_F = -24X_1X_2^2$. Thus $H(C)$ consists of the cuspidal tangent $V(X_2)$, counted twice, and the line $V(X_1)$ through the cusp $p = (1 : 0 : 0)$ and the inflection point $(0 : 0 : 1)$. We have

$$\begin{aligned} \text{mult}_p(C \cap V(X_2)) &= 3 \quad \text{and} \quad \text{mult}_p(C \cap V(X_1)) = 2, \text{ so} \\ \text{mult}_p(C \cap H(C)) &= 2 \cdot 3 + 2 = 8. \end{aligned}$$

c) For the folium of Descartes C with $F = X_1^3 + X_2^3 - X_0X_1X_2$, we have

$$\det H_F = -2(3X_1^3 + 3X_2^3 + X_0X_1X_2),$$

so the Hessian curve $H(C)$ is a reflected folium of Descartes. Its intersection with C consists of $p = (1 : 0 : 0)$ and the three inflection points at infinity

$$(0 : 1 : -1), \quad (0 : \zeta : -1), \quad \text{and} \quad (0 : \zeta^2 : -1),$$

where ζ is a primitive cube root of unity. Computing a resultant gives

$$\text{mult}_p(C \cap H(C)) = 6 = 2(1 + 2),$$

which corresponds to the intersection behavior of the four branches of the curve at p .

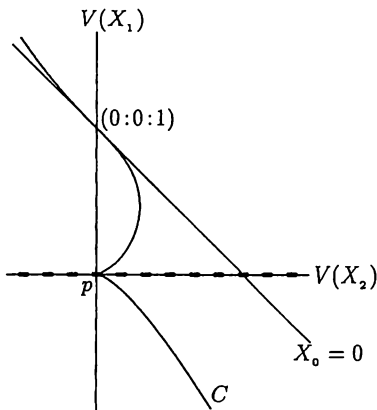

Figure 4.8. The cuspidal cubic and its Hessian curve

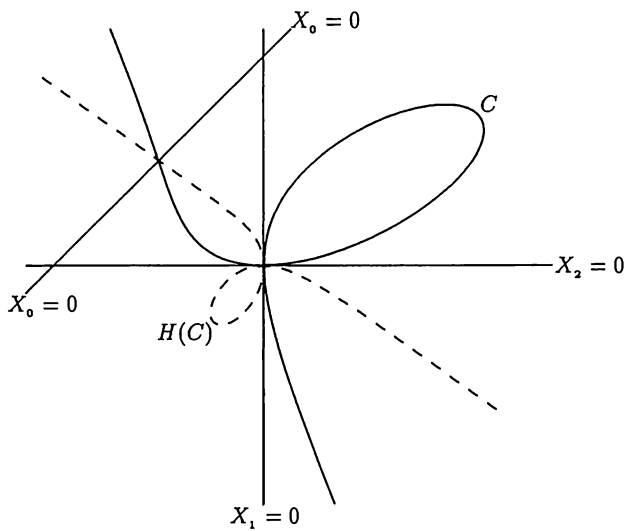

Figure 4.9. The folium of Descartes and its Hessian curve

The Dual Curve and the Plücker Formulas

An algebraic curve has many “invariants,” which in the simplest cases are natural numbers independent of the particular coordinates. Some examples are the degree of the curve and the number of components, singularities, inflection points, or bitangents. As we have seen, these numbers are not independent of each other: irreducible curves have singularities and inflection points only if the degree is at least 3; curves that contain no lines have bitangents only if the degree is at least 4; for fixed degree, singularities decrease the number of inflection points. Exact relationships among different invariants are contained in the Plücker formulas.

To prove the Plücker formulas we need a few complicated tools, in particular a local technique for computing the intersection multiplicities that occur. We use the formulas in this chapter even though they will not be justified until later, in the hope that the reader who anticipates nice applications will be more strongly motivated to study the following very technical chapters.

5.1. The first hurdle is the introduction of the dual curve, a subset of the *dual projective space* $\mathbb{P}_2^*(\mathbb{C})$. To a point $y = (y_0 : y_1 : y_2) \in \mathbb{P}_2^*(\mathbb{C})$ there corresponds the line

$$V(y_0X_0 + y_1X_1 + y_2X_2) \subset \mathbb{P}_2(\mathbb{C}).$$

This is the polar of $q = (y_0 : y_1 : y_2) \in \mathbb{P}_2(\mathbb{C})$ with respect to the quadric $V(X_0^2 + X_1^2 + X_2^2)$ (see Section 4.1). In order to see more of it in the real numbers, and to make the duality clear, one usually replaces it by the “circle” $V(X_0^2 - X_1^2 - X_2^2)$. Then the polar that corresponds to the pole $q = (q_0 : q_1 : q_2)$ is $V(q_0 X_0 - q_1 X_1 - q_2 X_2)$ (see [Fi], 3.4.1).

Definition. Let $C \subset \mathbb{P}_2(\mathbb{C})$ be an algebraic curve. Then

$$C^* := \{L \in \mathbb{P}_2^*(\mathbb{C}) : L \text{ is tangent to } C \text{ at some } p \in C\}$$

is called the *dual curve* of C .

By the definition in Section 3.4, the condition on L means that $\text{ord}_p(C) < \text{mult}_p(C \cap L)$. For each $p \in C$ there are only finitely many such lines. If C itself is a line, then C^* consists of a single point.

Theorem. Let $C \subset \mathbb{P}_2(\mathbb{C})$ be an algebraic curve that has no lines as components. Then

- a) $C^* \subset \mathbb{P}_2^*(\mathbb{C})$ is an algebraic curve;
- b) if C is irreducible, then C^* is irreducible and $\deg C^* \geq 2$;
- c) $C^{**} = C$.

Two very different techniques are used to prove this theorem:

- i) computing an *equation* for C^* from an equation for C ;
- ii) describing a *parametrization* for C^* by way of a parametrization for C .

Method (ii) is more elegant and geometrically more plausible, but requires more theoretical background. It starts with the fact that for a smooth curve C , there is a map

$$\sigma : C \rightarrow C^* \subset \mathbb{P}_2^*, \quad p \mapsto \left(\frac{\partial F}{\partial X_0}(p) : \frac{\partial F}{\partial X_1}(p) : \frac{\partial F}{\partial X_2}(p) \right).$$

This is explained in Section 5.3.

Method (i) is quite elementary, and further develops the arguments of Section 2.5 on determining the points of intersection of a curve with a line: Let $C = V(F)$, and let $L = V(y_0 X_0 + y_1 X_1 + y_2 X_2)$

be an arbitrary line. If $y_2 \neq 0$, we can use the equation of the line to eliminate X_2 from F . Let $n = \deg F$ and set

$$\begin{aligned} G(X_0, X_1) &:= y_2^n F \left(X_0, X_1, -\frac{1}{y_2}(y_0 X_0 + y_1 X_1) \right) \\ &= b_0 X_1^n + b_1 X_1^{n-1} X_0 + \cdots + b_n X_0^n, \end{aligned}$$

where $b_0, \dots, b_n \in \mathbb{C}[y_0, y_1, y_2]$ are homogeneous of degree n . The zeros of G correspond to the points of intersection of C and L . Now let $D \in \mathbb{C}[Y_0, Y_1, Y_2]$ be the discriminant of $g(X_1) = G(1, X_1)$, that is, the resultant of g and dg/dX_1 . Here the coordinates of $y = (y_0 : y_1 : y_2)$ are viewed as variables. D is homogeneous of degree $2n^2 - n$, and $D \neq 0$ by Corollary 4.3. Thus

$$C' := V(D) \subset \mathbb{P}_2^*$$

is an algebraic curve.

Now, if the line L determined by y is tangent to C , it has at least a double intersection point with C , so G has a multiple zero. If it is $(0 : 1)$, then $b_0(y) = 0$; otherwise g has a multiple zero. In either case, $D(y) = 0$, so $y \in C'$. This shows that $C^* \subset C'$, and we have a good chance of finding an equation for C^* from the factors of D . First, a few examples.

Examples

a) If $C \subset \mathbb{P}_2(\mathbb{C})$ is a smooth quadric, it has a corresponding symmetric matrix $A \in \text{GL}(3, \mathbb{C})$, so

$$F(X) = {}^t X A X,$$

where ${}^t X := (X_0, X_1, X_2)$ is a minimal polynomial of C . Since

$$\deg F = 2 {}^t X A,$$

the coordinates of $T_p C$ in $\mathbb{P}_2^*(\mathbb{C})$ are given by $(p_0 : p_1 : p_2) \cdot A$. Consider the map

$$\sigma : \mathbb{P}_2(\mathbb{C}) \rightarrow \mathbb{P}_2^*(\mathbb{C}), \quad x \mapsto {}^t x A = y.$$

Then $C^* = \sigma(C)$, and since

$$y \in C^* \iff x = {}^t (y A^{-1}) \in C \iff 0 = {}^t x A x = y A^{-1} ({}^t y),$$

C^* is the quadric described by A^{-1} . This proves the theorem above for quadrics.

If $F = a_0X_0^2 + a_1X_1^2 + a_2X_2^2$, then eliminating X_2 and computing the discriminant give

$$D = b_0(4b_0b_2 - b_1^2) = 4b_0Y_2^2(a_1a_2Y_0^2 + a_2a_0Y_1^2 + a_0a_1Y_2^2) = 4b_0Y_2^2F^*.$$

Here $b_0 = a_2Y_1^2 + a_1Y_2^2$, and F^* is clearly an equation for C^* .

b) The dual curve of the cuspidal cubic $C = V(X_1^3 - X_0X_2^2)$ can be found by considering the rational parametrization

$$\varphi : \mathbb{P}_1(\mathbb{C}) \rightarrow C \subset \mathbb{P}_2(\mathbb{C}), \quad (t_0 : t_1) \mapsto (t_0^3 : t_0t_1^2 : t_1^3).$$

We set

$$\phi = (\phi_0, \phi_1, \phi_2) = (t_0^3, t_0t_1^2, t_1^3).$$

Then, for $t \neq (1 : 0)$, the tangent to C at the point $\varphi(t)$ is spanned by the vectors $\partial\phi/\partial t_0$ and $\partial\phi/\partial t_1$ in \mathbb{C}^3 , i.e. by the rows of the matrix

$$\begin{pmatrix} 3t_0^2 & t_1^2 & 0 \\ 0 & 2t_0t_1 & 3t_1^2 \end{pmatrix}.$$

A linear equation for the tangent can be obtained by taking the minors of this matrix as coefficients—that is, from the cross product

$$(3t_1^4, -9t_0^2t_1^2, 6t_0^3t_1) = 3t_1(t_1^3, -3t_0^2t_1, 2t_0^3)$$

of the rows. Thus $y = (t_1^3 : -3t_0^2t_1 : 2t_0^3) \in \mathbb{P}_2^*(\mathbb{C})$ are the coordinates of the tangent not only for $t_1 \neq 0$ but also for $t = (1 : 0)$, because $V(X_2)$ is the cuspidal tangent. This gives a rational parametrization

$$\varphi^* : \mathbb{P}_1(\mathbb{C}) \rightarrow C^* \subset \mathbb{P}_2^*(\mathbb{C}), \quad (t_0 : t_1) \mapsto (t_1^3 : -3t_0^2t_1 : 2t_0^3).$$

The inflection point $(0 : 0 : 1) = \varphi^*(1 : 0)$ of C^* corresponds to the cusp $(1 : 0 : 0) = \varphi(1 : 0)$ of C , and the cusp $(1 : 0 : 0) = \varphi^*(0 : 1)$ corresponds to the inflection point $(0 : 0 : 1) = \varphi(0 : 1)$ of C .

Repeating the computation above with C^* shows that $C^{**} = C$. Eliminating X_0 in $F = X_1^3 - X_0X_2^2$ gives

$$G(X_1, X_2) = y_0^2(y_0X_1^3 + y_1X_1X_2^2 + y_2X_2^3),$$

$$D = Y_0^{12}(4Y_1^3 + 27Y_0Y_2^2) = Y_0^{12}F^*.$$

Substituting the parametrization into D , we see that F^* is a minimal polynomial of C^* .

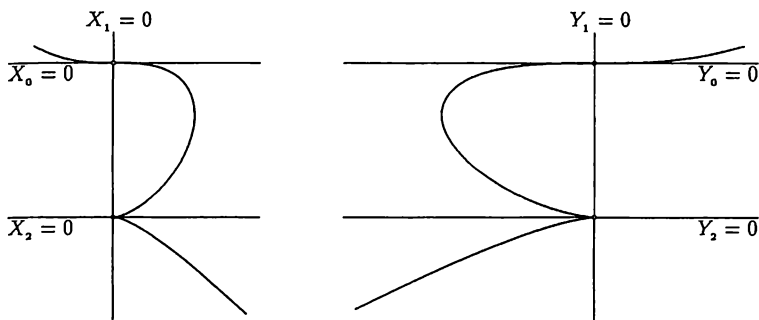

Figure 5.1. The cuspidal cubic and its dual curve

The first two examples might give the impression that there was no major difference between C and C^* . Nothing could be further from the truth, as the following example shows.

c) By Section 0.4, the nodal cubic has the rational parametrization

$$\begin{aligned} \varphi : \mathbb{P}_1(\mathbb{C}) &\rightarrow C \subset \mathbb{P}_2(\mathbb{C}), \\ (t_0 : t_1) &\mapsto (t_0^3 : t_0(t_1^2 - t_0^2) : t_1(t_0^2 - t_1^2)), \end{aligned}$$

and an argument as in Example (b) gives the parametrization

$$\begin{aligned} \varphi^* : \mathbb{P}_1(\mathbb{C}) &\rightarrow C^* \subset \mathbb{P}_2^*(\mathbb{C}), \\ (t_0 : t_1) &\mapsto ((t_0^2 - t_1^2)^2 : t_0^2(t_0^2 - 3t_1^2) : -2t_0^3t_1) \end{aligned}$$

for the dual curve. This is a heart-shaped quartic, which is called the *cardioid*; see Figure 5.2.

The double point $p = \varphi(1 : 1) = \varphi(1 : -1) \in C$ has two corresponding points, $q = \varphi^*(1 : 1)$ and $q' = \varphi^*(1 : -1)$, on the bitangent $V(Y_0) \subset \mathbb{P}_2^*(\mathbb{C})$. The inflection point $\tilde{p} = (0 : 0 : 1) = \varphi(0 : 1) \in C$ has a corresponding cusp $\tilde{q} = (1 : 0 : 0) \in C^*$. With a bit of computation, we also find that $\varphi^{**} = \varphi$.

If we use the equation $F = X_1^3 + X_0X_1^2 - X_0X_2^2$ for the nodal cubic, then the discriminant method yields

$$F^* = 4(Y_1^2 - Y_2^2)^2 - 4Y_0Y_1(Y_1^2 - 9Y_2^2) - 27Y_0^2Y_2^2$$

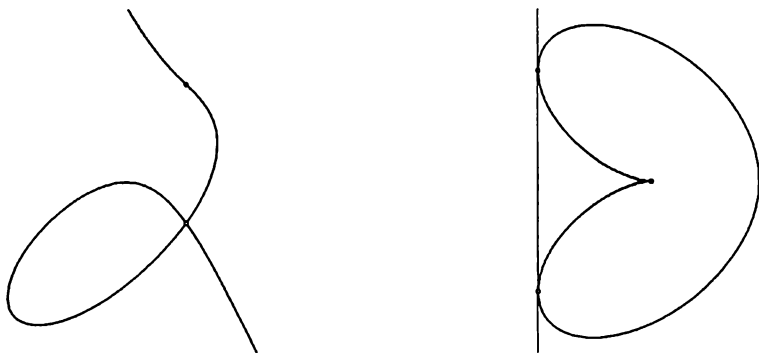

Figure 5.2. The nodal cubic and its dual cardioid

as an equation for the cardioid. Courageous readers who are good at computations are invited to substitute the parametrization into the equation.

d) The *hypocycloid of three cusps* C from Section 0.6 is placed so that the cusps lie at the basis points $p_0 = (1 : 0 : 0)$, $p_1 = (0 : 1 : 0)$, and $p_2 = (0 : 0 : 1)$. A rational parametrization of C can be obtained as follows: We start with the quadric

$$Q = V(Z_0^2 + Z_1^2 + Z_2^2 - 2Z_0Z_1 - 2Z_1Z_2 - 2Z_2Z_0) \subset \mathbb{P}_2(\mathbb{C})$$

parametrized by

$$\psi : \mathbb{P}_1(\mathbb{C}) \rightarrow Q,$$

$$(t_0 : t_1) \mapsto (4t_0^2 : (t_0 + t_1)^2 : (t_0 - t_1)^2) = (Z_0 : Z_1 : Z_2).$$

Now we apply a so-called *Cremona transformation*

$$X_0 = Z_1Z_2, \quad X_1 = Z_2Z_0, \quad X_2 = Z_0Z_1,$$

with “inverse transformation”

$$Z_0 = X_1X_2, \quad Z_1 = X_2X_0, \quad Z_2 = X_0X_1.$$

It is easy to see that this gives a bijective map

$$\sigma : \mathbb{P}_2 \setminus V(X_0X_1X_2) \rightarrow \mathbb{P}_2 \setminus V(Z_0Z_1Z_2),$$

where $\sigma = \sigma^{-1}$. The action of this map on the “basis triangle” $V(X_0X_1X_2)$ is a bit unusual: If the basis points are denoted as above

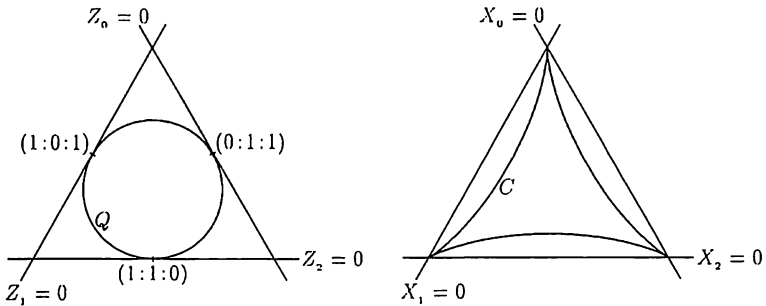

Figure 5.3. Cremona transformation of the circle and of the hypocycloid

by $p_0 = (1 : 0 : 0)$, $p_1 = (0 : 1 : 0)$, and $p_2 = (0 : 0 : 1)$, then $\sigma(V(X_i)) = p_i$. In the other direction, one can say that the points p_i at which σ becomes indeterminate are “blown up” under σ to the lines $V(X_i)$.

The quadric Q does not pass through any of the basis points, so we can combine ψ with σ to get the parametrization

$$(X_0 : X_1 : X_2) = ((t_0 + t_1)^2(t_0 - t_1)^2 : 4t_0^2(t_0 - t_1)^2 : 4t_0^2(t_0 + t_1)^2).$$

Its image is a *hypocycloid*

$$C = V(X_0^2X_1^2 + X_1^2X_2^2 + X_2^2X_0^2 - 2X_0X_1X_2(X_0 + X_1 + X_2)).$$

The resulting parametrization of C^* is

$$(Y_0 : Y_1 : Y_2) = (-8t_0^3 : (t_0 + t_1)^3 : (t_0 - t_1)^3).$$

This is a cubic with the three real inflection points

$$(0 : 1 : -1), \quad (1 : 0 : -1), \quad \text{and} \quad (1 : -1 : 0)$$

on the line $Y_0 + Y_1 + Y_2 = 0$. (See Figure 5.4.) Corresponding to the parameter values $(t_0 : t_1) = (1 : \pm i\sqrt{3})$, we get the double point $(1 : 1 : 1)$ of C^* and the bitangent

$$X_0 + X_1 + X_2 = 0$$

to C . The two points of tangency of the bitangent are

$$(1 : \zeta : \zeta^2) \text{ and } (1 : \zeta^2 : \zeta), \text{ where } \zeta = \exp\left(\frac{2\pi i}{3}\right).$$

These are also the non-real points of intersection of C and Q .

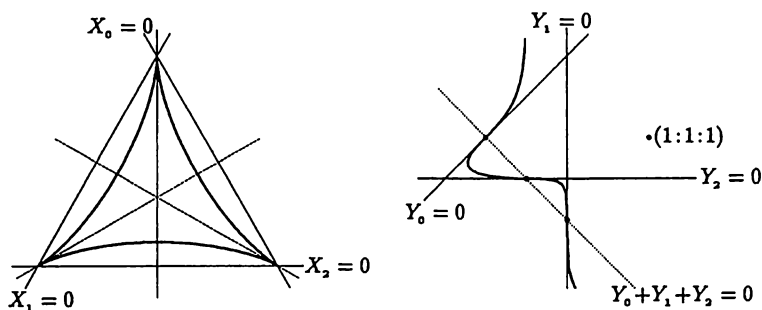

Figure 5.4. The hypocycloid of three cusps and its dual curve

Computing an equation for C^* by the discriminant method is hard. If we examine the parametrization carefully, we find that

$$F^* = (Y_0 + 4Y_1 + 4Y_2)(2Y_0 - Y_1 - Y_2)^2 + 27Y_0(Y_1 - Y_2)^2.$$

5.2. Having given these examples, we now want to finish the *proof of part (a)* of the theorem on the dual curve that was begun in Section 5.1. We claim that there are lines $L_1^*, \dots, L_k^* \subset \mathbb{P}_2^*$ such that

$$C' = C^* \cup L_1^* \cup \dots \cup L_k^*. \quad (*)$$

Thus, simplifying D by taking out linear factors will lead to an equation for C^* .

The first type of linear factor comes from the points $C \cap V(X_0)$. Let $x = (0 : x_1 : x_2) \in C$. We may assume that $(0 : 0 : 1) \notin C$, so $x_1 \neq 0$. If $y \in \mathbb{P}_2^*$ is a line through x , then it must have the form $y = (y_0 : -x_2 : x_1)$. Since $b_0(y)x_1^n = G(0, x_1) = 0$, we have $b_0(y) = 0$. Hence $x_1Y_1 + x_2Y_2$ is a divisor of b_0 and thus also of D , and

$$L' := V(x_1Y_1 + x_2Y_2) \subset C'$$

is an irreducible component (see Example (a)).

If $x = (x_0 : x_1 : x_2)$ is singular, we may assume that $x_0 = 1$. If y is a line through x , then $G(1, X_1)$ has a multiple zero at $X_1 = x_1$, so $D(y) = 0$. Hence the line

$$L'' := V(x_0Y_0 + x_1Y_1 + x_2Y_2) \subset C'$$

is another irreducible component (see Example (b)).

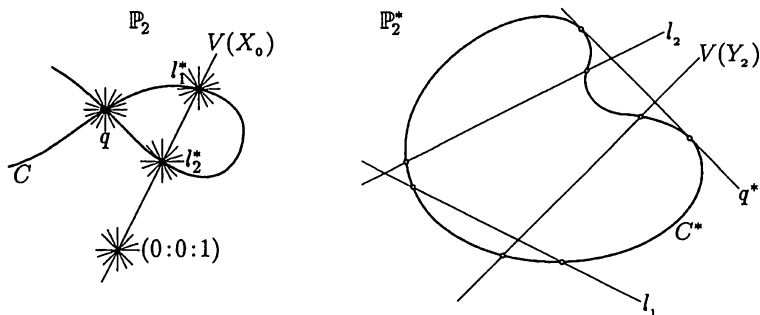
Figure 5.5. Linear factors of D

Now let L_1^*, \dots, L_k^* be the finitely many lines of type L' and L'' constructed above. To prove (*) it remains to show that C^* is the closure of

$$C' \setminus (L_1^* \cup \dots \cup L_k^*)$$

in the topology of \mathbb{P}_2^* . But this follows from Theorem 3.6. We have proved part (a) of Theorem 5.1. \square

5.3. In the examples of Section 5.1, we were able to check assertions (b) and (c) of the theorem by means of a rational parametrization. Using a compact Riemann surface instead of the Riemann sphere gives a similar *parametrization* for arbitrary irreducible curves.

Theorem. *For every irreducible algebraic curve $C \subset \mathbb{P}_2(\mathbb{C})$, there exist a compact Riemann surface S and a holomorphic map*

$$\varphi : S \rightarrow C$$

that is biholomorphic away from the singularities of C .

This is called a *resolution of singularities* of C . This result is proved in Chapter 9. It is crucial that S is connected.

If $p \in C$ is a singular point, $\varphi^{-1}(p) \subset S$ may consist of several (at most finitely many) points. The local branches of C through p correspond to this inverse image; these branches give rise to the distinct tangents through p and the multi-valuedness of the desired

map $\sigma : C \rightarrow C^*$. We will now use $\varphi : S \rightarrow C$ to construct a holomorphic (and globally single-valued) parametrization

$$\varphi^* : S \rightarrow C^*.$$

First we do this locally. Let $o \in S$ be a fixed point, and let t be a coordinate, centered at o , in a sufficiently small open neighborhood $U \subset S$. For $\varphi|U$ there exists a *local lift*, i.e. a holomorphic map

$$\phi : U \rightarrow \mathbb{C}^3 \setminus \{0\}, \quad t \mapsto (\phi_0(t), \phi_1(t), \phi_2(t)),$$

such that $\varphi|U = (\phi_0 : \phi_1 : \phi_2)$. Let $\dot{\phi}_i = d\phi_i/dt$ and

$$A = \begin{pmatrix} \phi_0 & \phi_1 & \phi_2 \\ \dot{\phi}_0 & \dot{\phi}_1 & \dot{\phi}_2 \end{pmatrix}.$$

The map φ is an immersion at a point t if and only if the rows of A are linearly independent (for that t). In this case, the tangent $T_{\varphi(t)}C \subset \mathbb{P}_2$ is spanned by the two vectors $\phi(t), \dot{\phi}(t) \in \mathbb{C}^3$. The equation of this tangent is given by

$$a_0(t)X_0 + a_1(t)X_1 + a_2(t)X_2 = 0,$$

where $a_i := (-1)^i \det A_i$. Here A_i , for $i = 0, 1, 2$, comes from omitting the i th column of A . Thus we obtain

$$\varphi^*(t) = (a_0(t) : a_1(t) : a_2(t)) \in \mathbb{P}_2^*$$

if φ is an immersion in t . The minors a_i are holomorphic; that is, the map

$$U \rightarrow \mathbb{C}^3, \quad t \mapsto (a_0(t), a_1(t), a_2(t))$$

is holomorphic. Now it is easy to see that extending this to the points where φ is not an immersion will give a holomorphic map

$$\varphi^* : U \rightarrow \mathbb{P}_2^*.$$

Lemma 1. *Let $0 \in U \subset \mathbb{C}$ and let $\Psi : U \rightarrow \mathbb{C}^3$ be holomorphic, where the only zero of Ψ is 0. Then the map*

$$\psi : U \setminus \{0\} \rightarrow \mathbb{P}_2(\mathbb{C}), \quad t \mapsto (\Psi_0(t) : \Psi_1(t) : \Psi_2(t)),$$

admits a holomorphic extension to 0.

Proof. If $k \geq 1$ is the minimum of the orders of the zeros of the Ψ_i at 0, then

$$\Psi(t) = t^k \tilde{\Psi}(t), \quad \text{where } \tilde{\Psi}(0) \neq (0, 0, 0).$$

Setting $\psi(0) := (\tilde{\Psi}_0(0) : \tilde{\Psi}_1(0) : \tilde{\Psi}_2(0))$ gives the desired extension. \square

Lemma 2. *The local parametrizations $\varphi^* : U \rightarrow \mathbb{P}_2^*$ obtained in this way are independent of the choice of the local lift ϕ and the local coordinate t .*

The *proof* is left to the reader as an exercise. In the course of the proof one obtains a global parametrization, i.e. a holomorphic map $\varphi^* : S \rightarrow \mathbb{P}_2^*$. By Theorem 3.6, $\varphi^*(S) = C^*$.

It is immediate that C^* is irreducible. For suppose $C^* = C_1 \cup C_2$, where $C_1 \neq C_2$. Then consider the sets $S_i := \varphi^{*-1}(C_i) \subset S$ for $i = 1, 2$. Since the C_i are algebraic curves and φ^* is holomorphic, the subsets $S_i \neq S$ can be described locally as zero sets of holomorphic functions. Since S is compact and connected, they must be finite. But this contradicts $S = S_1 \cup S_2$.

If C^* were a line, then infinitely many tangents to C would pass through a fixed point $q \in \mathbb{P}_2$, which is impossible by Section 4.3. This proves part (b) of Theorem 5.1.

5.4. If we dualize the projective space twice, we recover the original space; in symbols, $(\mathbb{P}_n^*)^* = \mathbb{P}_n$. Assertion (c) of Theorem 5.1 states that such a duality also holds for plane algebraic curves. We will not only prove the equation $C^{**} = C$ but also show how the critical points of a curve change under dualization. To do this, we use a special local form of the holomorphic parametrization of Section 5.3.

Lemma. *Let $U \subset \mathbb{C}$ be an open neighborhood of the origin, and let $\varphi : U \rightarrow \mathbb{P}_2(\mathbb{C})$ be a holomorphic map such that $\varphi(U)$ is not contained in a line. Then there are uniquely determined $\alpha_1, \alpha_2 \in \mathbb{N}$ such that, after a linear transformation of $\mathbb{P}_2(\mathbb{C})$, φ can be written as $\varphi(t) = (\varphi_0(t) : \varphi_1(t) : \varphi_2(t))$, where*

$$\varphi_0 = 1, \quad \varphi_1 = t^{1+\alpha_1} + \dots, \quad \varphi_2 = t^{2+\alpha_1+\alpha_2} + \dots.$$

Here \dots stands for terms of higher order in t .

The numbers α_1, α_2 are called *local numerical invariants* of the parametrization φ at the point 0.

Proof. Let $\phi : U \rightarrow \mathbb{C}^3 \setminus \{0\}$ be a lift of φ , and consider the sequence of derivatives with respect to t :

$$\phi(0), \phi'(0), \dots, \phi^{(k)}(0), \dots \in \mathbb{C}^3.$$

Since $\varphi(U)$ does not lie on a line, there are $\alpha_1, \alpha_2 \in \mathbb{N}$ such that

$$\left(\phi(0), \phi^{(1+\alpha_1)}(0), \phi^{(2+\alpha_1+\alpha_2)}(0) \right) \text{ is a basis of } \mathbb{C}^3.$$

Choose the minimal α_1, α_2 with this property and adapt the coordinates as follows: Let $\phi(0) = (1, 0, 0)$ and $\phi_0 = 1$. Then

$$(\phi_1(t), \phi_2(t)) = t^{1+\alpha_1} (\phi'_1(t), \phi'_2(t)), \quad \text{where } (\phi'_1(0), \phi'_2(0)) \neq (0, 0),$$

by the definition of α_1 . We can change coordinates again so that $(\phi'_1(0), \phi'_2(0)) = (1, 0)$. By the definition of α_2 ,

$$\phi'_2(t) = t^{1+\alpha_2} \phi''_2(t), \quad \text{where } \phi''_2(0) \neq 0.$$

Thus

$$\phi_2(t) = t^{2+\alpha_1+\alpha_2} \phi''_2(t).$$

Finally, if we change coordinates so that $\phi''_2(0) = 1$, then the assertion follows. Uniqueness follows easily from the minimality of α_1 and α_2 . \square

Let $C = \varphi(U)$. This is a piece of a curve, and is defined and holomorphic in a neighborhood of $p = \varphi(0)$. The order of C and its intersection multiplicity with a line can be defined by means of an analytic equation, as was done in Chapter 3. An elementary computation with power series gives

$$1 + \alpha_1 = \text{ord}_p(C) \quad \text{and} \quad 2 + \alpha_1 + \alpha_2 = \text{mult}_p(C \cap T_p C).$$

(Precise justifications are given in Chapter 8.)

In particular, it follows that

$$p \text{ is a singularity of } C \iff \alpha_1 \neq 0$$

$$p \text{ is an inflection point of } C \iff \alpha_2 \neq 0 \text{ (and } \alpha_1 = 0).$$

5.5. Now we can use the special coordinates of Section 5.4 to compute the minors of Section 5.3 and explicitly describe the passage from a curve C to its dual curve C^* . Let

$$\varphi : S \rightarrow \mathbb{P}_2(\mathbb{C}) \quad \text{and} \quad \varphi^* : S \rightarrow C^* \subset \mathbb{P}_2(\mathbb{C})$$

be holomorphic parametrizations. For $o \in S$ and $o \in U \subset S$, let $\varphi|U = (\phi_0 : \phi_1 : \phi_2)$, with

$$\begin{aligned} \phi_0 &= 1 & \dot{\phi}_0 &= 0 \\ \phi_1 &= t^{1+\alpha_1} + \dots & \text{thus} \quad \dot{\phi}_1 &= (1 + \alpha_1)t^{\alpha_1} + \dots \\ \phi_2 &= t^{2+\alpha_1+\alpha_2} + \dots; & \dot{\phi}_2 &= (2 + \alpha_1 + \alpha_2)t^{1+\alpha_1+\alpha_2} + \dots \end{aligned}$$

Computing the minors gives

$$\begin{aligned} a_0 &= (1 + \alpha_2)t^{2+2\alpha_1+\alpha_2} + \dots \\ a_1 &= -(2 + \alpha_1 + \alpha_2)t^{1+\alpha_1+\alpha_2} + \dots \\ a_2 &= (1 + \alpha_1)t^{\alpha_1} + \dots \end{aligned}$$

According to the lemma in Section 5.4, to obtain the parametrization $\varphi^*|U$ from the map $(a_0, a_1, a_2) : U \rightarrow \mathbb{C}^3$ we have to factor out the highest common power of t (which is t^{α_1}). This gives

$$\begin{aligned} \phi_0^* &= (1 + \alpha_2)t^{2+\alpha_2+\alpha_1} + \dots \\ \phi_1^* &= -(2 + \alpha_1 + \alpha_2)t^{1+\alpha_2} + \dots \\ \phi_2^* &= (1 + \alpha_1) + \dots \end{aligned}$$

Letting α_1^* and α_2^* denote the local numerical invariants of φ^* , we see that

$$\alpha_1^* = \alpha_2 \quad \text{and} \quad \alpha_2^* = \alpha_1.$$

To obtain φ^{**} and hence C^{**} , we have to differentiate ϕ^* and compute minors again. The result is

$$c \cdot t^{\alpha_1} (1 + \dots : t^{1+\alpha_1} + \dots : t^{2+\alpha_1+\alpha_2} + \dots) = c \cdot t^{\alpha_2} \varphi^{**}(t),$$

where $c = (1 + \alpha_1)(1 + \alpha_2)(2 + \alpha_1 + \alpha_2)$. In particular,

$$\varphi^{**}(o) = (1 : 0 : 0) = \varphi(o), \quad \text{so} \quad C^{**} = C$$

because $o \in S$ was arbitrary.

This concludes the proof of Theorem 5.1 on the dual curve. \square

Exercise. Consider how a linear change of coordinates of $\mathbb{P}_2(\mathbb{C})$ affects the dual map φ^* .

5.6. As further preparation for the Plücker formulas, we need characterizations of the simplest singularities of curves. By Section 3.3, a point $p \in C$ is singular if and only if $\text{ord}_p(C) \geq 2$. The simplest case is $\text{ord}_p(C) = 2$. If $F(X_0, X_1, X_2)$ is a minimal polynomial of C , $p = (1 : 0 : 0)$, and $f(X_1, X_2) = F(1, X_1, X_2)$, then we have the expansion

$$f = f_{(2)} + f_{(3)} + \cdots + f_{(n)},$$

where $f_{(k)} \in \mathbb{C}[X_1, X_2]$ are homogeneous polynomials and we may assume that $n = \deg C$. For

$$f_{(2)} = c_0 X_1^2 + c_1 X_1 X_2 + c_2 X_2^2,$$

there are two cases to be considered.

a) If $c_1^2 \neq 4c_0c_2$, then $f_{(2)}$ has two distinct zeros in $\mathbb{P}_1(\mathbb{C})$; that is, C has two distinct tangents at p . In the terminology of Section 3.4, p is an ordinary double point. In this case, we can change coordinates so that $f_{(2)} = X_1 X_2$. For each of the two tangents T at p , we have $\text{mult}_p(C \cap T) \geq 3$. We call p a *simple double point* if

$$\text{ord}_p(C) = 2 \quad \text{and} \quad \text{mult}_p(C \cap T) = 3.$$

The second condition means that X_1 and X_2 are not divisors of $f_{(3)}$, so if

$$f_{(3)} = d_0 X_1^3 + d_1 X_1^2 X_2 + d_2 X_1 X_2^2 + d_3 X_2^3,$$

then $d_0 \neq 0$ and $d_3 \neq 0$. We assume that $d_0 = d_3 = -1$. Then the *affine equation of a simple double point* is given by

$$f = X_1 X_2 - X_1^3 - X_2^3 + h,$$

where

$$\text{ord}_p(h) \geq 3 \quad \text{and} \quad X_1 X_2 \text{ divides } h_{(3)}.$$

In the language of local branches, the condition $\text{mult}_p(C \cap T) = 3$ means that no branch at p has an inflection point.

In the terminology of Section 6.14, a curve has two local branches at a simple double point, and these branches in themselves are smooth. The two tangents have equations $X_1 = 0$ and $X_2 = 0$. By the implicit

function theorem (Sections 6.9 and A.3), the branch with tangent $X_2 = 0$ has a parametrization

$$t \mapsto (t, \varphi(t)),$$

where φ is holomorphic and $\varphi(0) = 0$. We must have $f(t, \varphi(t)) = 0$. Because of the special form of f , it follows that

$$\varphi(t) = t^2 + \sum_{\nu \geq 3} \beta_\nu t^\nu.$$

A parametrization

$$t \mapsto \left(t^2 + \sum_{\nu \geq 3} \gamma_\nu t^\nu, t \right)$$

for the other branch can be obtained in the same way.

b) For $c_1^2 = 4c_0c_2$, $f_{(2)}$ has a double zero, so C has only one tangent at p ; p is a *cusp* of C . We can change coordinates so that $f_{(2)} = X_2^2$. Then $T = V(X_2)$ is the *cuspidal tangent*. The cusp is called *simple* if

$$\text{mult}_p(C \cap T) = 3.$$

With $f_{(3)}$ as above, this means that $d_0 \neq 0$. We may assume that $d_0 = -1$. This gives

$$f = X_2^2 - X_1^3 + X_2g + h,$$

where g is homogeneous of degree 2 and $\text{ord}_p(h) \geq 4$, as the *affine equation of a simple cusp*.

As will be proved in Chapter 7, there is a local parametrization around p of the form

$$t \mapsto (t^n, \varphi(t)),$$

where $n = \text{ord}_p C = 2$. Comparing coefficients in $f(t^n, \varphi(t)) = 0$ shows that

$$\varphi(t) = t^3 + \sum_{\nu \geq 4} \alpha_\nu t^\nu.$$

This gives the local parametrization

$$t \mapsto (t^2, t^3 + \dots)$$

of the simple cusp, and for the local numerical invariants (see Sections 5.4 and 5.5) it follows that

$$\alpha_1 = 1, \alpha_2 = 0 \quad \text{and} \quad \alpha_1^* = 0, \alpha_2^* = 1.$$

Thus simple cusps correspond to simple inflection points under duality.

5.7. For an algebraic curve $C \subset \mathbb{P}_2(\mathbb{C})$, the maximum possible number of tangents that can be drawn from a point $q \in \mathbb{P}_2(\mathbb{C})$ to smooth points of C is called the *class* of C .

Remark 1. Let $C \subset \mathbb{P}_2(\mathbb{C})$ be irreducible, with $\deg C \geq 2$, and let $C^* \subset \mathbb{P}_2^*(\mathbb{C})$ be the dual curve. Then the class n^* of C equals $\deg C^*$. The maximum number n^* of tangents is attained for almost all $q \in \mathbb{P}_2(\mathbb{C})$.

Proof. Under duality, to a point $q \in \mathbb{P}_2$ there corresponds a line $q^* \subset \mathbb{P}_2^*$, namely the pencil of lines in \mathbb{P}_2 that pass through q . By the definition of the dual curve, to each point in $q^* \cap C^*$ there corresponds a tangent to C through q . By Section 2.5, $q^* \cap C^*$ consists of n^* points, counted with multiplicities, and for almost all lines q^* all the points of intersection are simple (Corollary 4.3). \square

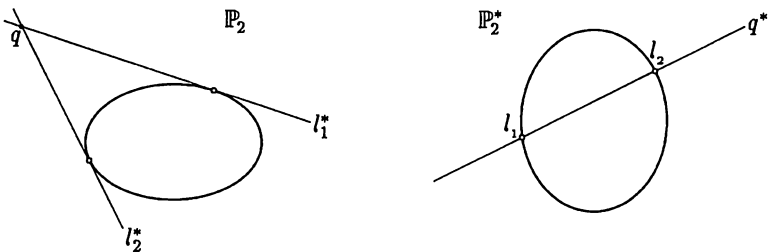

Figure 5.6

For brevity, we call an algebraic curve $C \subset \mathbb{P}_2(\mathbb{C})$ a *Plücker curve* if it has the following properties:

- a) C is irreducible and $\deg C \geq 2$.
- b) The singularities of C and C^* are at most simple double points and simple cusps.

The following quantities are invariants:

$$\begin{aligned} d &:= \# \text{ double points of } C, & d^* &:= \# \text{ double points of } C^*, \\ s &:= \# \text{ cusps of } C, & s^* &:= \# \text{ cusps of } C^*. \end{aligned}$$

Remark 2. For a Plücker curve C , we have

- a) $d^* = \# \text{ bitangents of } C$,
- b) $s^* = \# \text{ inflection points of } C$,
- a)* $d = \# \text{ bitangents of } C^*$,
- b)* $s = \# \text{ inflection points of } C^*$.

Proof. (a) follows by duality arguments, as in Remark 1, and (b) was proved in Section 5.6. (a)* and (b)* are dual to (a) and (b). \square

The following relations hold among all these invariants.

Plücker formulas. For a Plücker curve $C \subset \mathbb{P}_2(\mathbb{C})$ of degree n and class n^* , we have

- 1) $n^* = n(n-1) - 2d - 3s$ (class formula),
- 2) $s^* = 3n(n-2) - 6d - 8s$ (inflection point formula),
- 1)* $n = n^*(n^* - 1) - 2d^* - 3s^*$,
- 2)* $s = 3n^*(n^* - 2) - 6d^* - 8s^*$.

Remark 3. Note that, in the case of a Plücker curve C , the singularities of C^* are restricted as well. As an exercise, the reader is invited to consider the following:

- a) Translate the condition that C^* has a simple double point or a simple cusp into equivalent conditions on the corresponding inflection points or bitangents of C .
- b) Every irreducible quadric or cubic is a Plücker curve.
- c) Give an example of an irreducible quartic that is not a Plücker curve.
- d) For every $n \geq 2$ there is a Plücker curve of degree n .

5.8. First, we give a few simple examples.

Examples.

a) For an irreducible quadric, $n = 2$; the Plücker formulas give

$$2 \leq n^* = 2 - 2d - 3s \quad \text{and} \quad 0 \leq s^* = 6d - 8s.$$

Thus $n^* = 2$ and $d = s = d^* = 0$, which of course is also clear without the Plücker formulas.

b) By Section 3.8, an irreducible cubic has at most one singular point. The Plücker formulas give

$$n^* = 6, \quad s^* = 9, \quad d^* = 0 \quad \text{for } d = s = 0,$$

$$n^* = 4, \quad s^* = 3, \quad d^* = 0 \quad \text{for } d = 1,$$

$$n^* = 3, \quad s^* = 1, \quad d^* = 0 \quad \text{for } s = 1.$$

(See the examples in Section 5.1.)

c) For a smooth Plücker quartic,

$$n^* = 12, \quad s^* = 24, \quad d^* = 28,$$

and $d^* < 28$ if $d > 0$ or $s > 0$. Felix Klein's quartic in Section 0.7 has 28 bitangents, which are even real, but in contrast only 8 real inflection points. Hence over the complex numbers there are no further bitangents, no singularities, but 16 more inflection points.

The Plücker formulas admit a number of generalizations, and many geometers since Plücker's time have pursued them. In the case of the class formula, for instance, one can ask with what weight an arbitrary singularity of a curve should be counted (the weight is 2 for simple double points, 3 for simple cusps). This first generalization, given by Weierstrass and Max Noether, can be found in Section A.5.3. Clebsch's genus formula, which we prove for Plücker curves in Section 9.8 and in general in Section A.5.4, shows a connection with the estimate of the number of singularities.

5.9. The *proof of the Plücker formulas* of Section 5.7 is straightforward in principle because it can be reduced to Bézout's theorem. The only difficulty is in computing the intersection multiplicities.

It suffices to prove formulas (1) and (2); (1)* and (2)* follow by dualizing.

To prove the *class formula* we intersect the curve C with a polar P_qC , where the point q is chosen to be sufficiently general. First, by Remark 1 of Section 5.7, there must be exactly n^* tangents through q to smooth points p_1, \dots, p_{n^*} of C . Since C is a Plücker curve, it suffices to choose q not to lie on any of the finitely many bitangents and inflectional tangents of C .

We now use the properties of P_qC from Sections 4.2 and 4.3, and apply Bézout's theorem in the form for divisors (the polynomial D_qF is not necessarily minimal). By the proposition of Section 4.3,

$$\text{mult}_p(C \cap P_qC) = 1 \quad \text{for } p \in \{p_1, \dots, p_{n^*}\}.$$

Hence, by Bézout,

$$n(n-1) = n^* + \sum_{p \in \text{Sing } C} \text{mult}_p(C \cap P_qC).$$

For smooth curves, $n^* = n(n-1)$; the sum over the singularities in the formula above *reduces the class*. We may further assume that q does not lie on any of the tangents through a singular point. It remains to show that, with this assumption,

$$\text{mult}_p(C \cap P_qC) = \begin{cases} 2 & \text{if } p \text{ is a simple double point,} \\ 3 & \text{if } p \text{ is a simple cusp.} \end{cases}$$

For a double point $p = (1 : 0 : 0)$ we have, by Section 5.6,

$$F = X_0^{n-2}X_1X_2 + G(X_0, X_1, X_2),$$

$$\text{where } \text{ord}_p(G(1, X_1, X_1)) \geq 3.$$

Thus

$$D_qF = q_2X_0^{n-2}X_1 + q_1X_0^{n-2}X_2 + H(X_0, X_1, X_2),$$

$$\text{where } \text{ord}_p(H(1, X_1, X_2)) \geq 2.$$

Now, $q_1 \neq 0$ and $q_2 \neq 0$ by the choice of q . Hence the polar P_qC is smooth at p , and (see Example (d) of Section 4.1) it follows that

$$\text{mult}_p(C \cap P_qC) = 2.$$

If p is a simple cusp, then

$$F = X_0^{n-2} X_2^2 - X_0^{n-3} X_1^3 + X_0^{n-2} X_2 g(X_1, X_1) + H(X_0, X_1, X_2)$$

by Section 5.6, so

$$D_q F = 2q_2 X_0^{n-2} X_2 + G(X_0, X_1, X_2),$$

$$\text{where } \text{ord}_p(G(1, X_1, X_2)) \geq 2.$$

Now, $q_2 \neq 0$ since q does not lie on the cuspidal tangent $V(X_2)$. It follows that $P_q C$ is smooth at p , with tangent $V(X_2)$. This is the critical case for the intersection multiplicity by Theorem 3.5, so $\text{mult}_p(C \cap P_q C) > 2$. Examples 3.5 and 4.1 c) make it seem plausible that the multiplicity must be 3, but using the appropriate resultant to prove this is quite hard. The method of Section 8.4 makes the proof obvious: Substituting the local parametrization

$$X_0 = 1, \quad X_1(t) = t^2, \quad X_2(t) = t^3 + \dots$$

of the cusp into $D_q F$ gives

$$\varphi(t) = 2q_2 t^3 + \psi(t),$$

where $\text{ord}_0(\psi) \geq 4$; hence

$$\text{mult}_p(C \cap P_q C) = \text{ord}_0(\varphi) = 3.$$

Similarly, the *inflection point formula* (2) follows from the intersection behavior of C with the Hessian curve $H(C)$ (see Section 4.4). The inequality $s^* \leq 3n(n-2)$ from Section 4.5 can be made precise:

$$s^* = 3n(n-2) - \sum_{p \in \text{Sing } C} \text{mult}_p(C \cap H(C)).$$

Here we used the fact that the s^* points where $H(C)$ intersects C at smooth points of C are all simple (Theorem 4.5) because, by hypothesis, C^* has only simple cusps. Thus (see the examples in Section 4.6) it remains to show that

$$\text{mult}_p(C \cap H(C)) = \begin{cases} 6 & \text{if } p \text{ is a simple double point,} \\ 8 & \text{if } p \text{ is a simple cusp.} \end{cases}$$

If $p = (1 : 0 : 0)$ is a simple double point, we can set $X_0 = 1$. Starting with the equation

$$f = X_1 X_2 - X_1^3 - X_2^3 + h,$$

we look for the terms of lowest order in X_1, X_2 in the representation of $\det H_F$ of Section 4.4. Using this, we obtain the expansion of $\det H_F$ at p :

$$\det H_F(1, X_1, X_2) = (n-1)(n-2)X_1X_2 + n(n-1)(X_1^3 + X_2^3) + \tilde{h}.$$

Hence the Hessian curve $H(C)$ also has a simple double point at p , with the same tangent as C . Recall the parametrization of a branch of C obtained in Section 5.6:

$$X_1 = t, \quad X_2 = t^2 + \dots, \quad \text{or} \quad X_1 = t^2 + \dots, \quad X_2 = t.$$

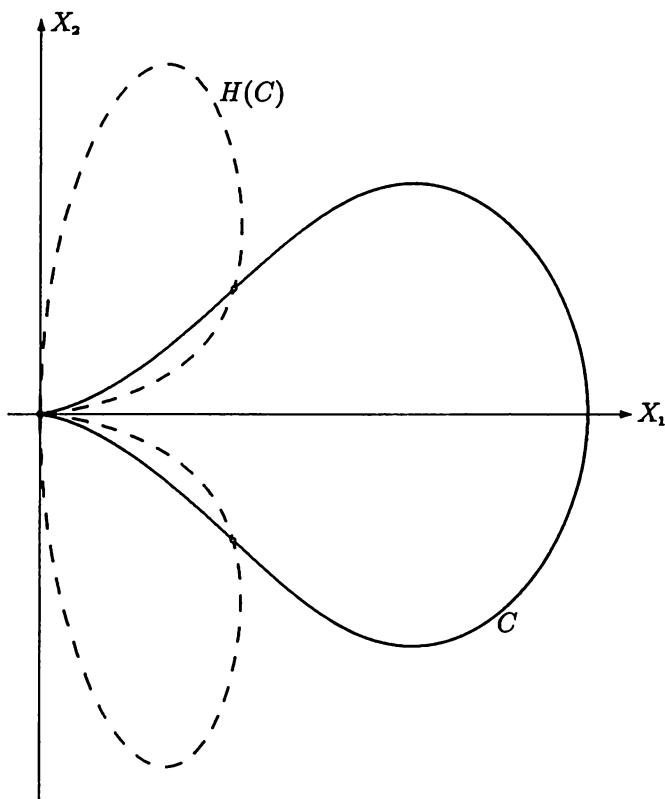

Figure 5.7. A Plücker curve and its Hessian curve

Substituting this into $\det H_F$ gives

$$\varphi(t) = 2(n-1)^2 t^3 + \psi(t),$$

where $\text{ord}_0(\psi) \geq 4$, for each of the two branches. Hence

$$\text{mult}_p(C \cap H(C)) = 2 \cdot \text{ord}_0(\varphi) = 2 \cdot 3 = 6,$$

by Section 8.4. (See also Example (c) of Section 4.6.) Finally, if p is a simple cusp, then starting with

$$f = X_2^2 - X_1^3 + d_1 X_1^2 X_2 + \dots$$

(see Section 5.6) and looking for lowest-order terms—the reader should have a large sheet of paper handy—leads to

$$\begin{aligned} \det H_F(1, X_1, X_2) \\ = 4(n-1)(n-2)(3X_1 - d_1 X_2)X_2^2 - 6(n-1)(n-3)X_1^4 + \dots \end{aligned}$$

If we substitute into this the parametrization

$$X_1(t) = t^2, \quad X_2(t) = t^3 + \dots$$

of C at p , we obtain

$$\varphi(t) = \alpha t^8 + \psi(t), \quad \text{where } \alpha \neq 0 \text{ and } \text{ord}_0(\psi) \geq 9.$$

This also proves that $\text{mult}_p(C \cap H(C)) = 8$. □

We conclude from the Newton polygon of $\det H_F$ (see Appendix 4) that $H(C)$ has one smooth and one singular branch at p . For $n = 3$, the singular branch is a double line (see Example (a) of Section 4.6).

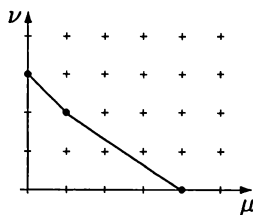

Figure 5.8. Newton polygon of $\det H_F$

The Ring of Convergent Power Series

6.1. The nodal cubic (see Section 0.4) is described by the irreducible polynomial

$$f(X_1, X_2) = X_2^2 - X_1^2(X_1 + 1).$$

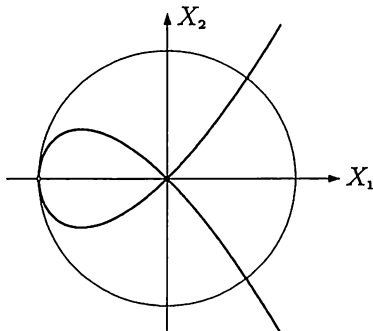

Figure 6.1. The nodal cubic in a neighborhood of the origin

The curve as a whole is irreducible, but considered only in a small neighborhood of the origin, it splits into two “local branches.” To give a more precise description of this intuitive passage from a global to a local approach, we have to switch from polynomials to convergent power series, that is, to analytic functions. This is easy to see for the

nodal cubic. We have

$$f(X_1, X_2) = \left(X_2 + X_1 \sqrt{X_1 + 1} \right) \left(X_2 - X_1 \sqrt{X_1 + 1} \right) = f_1 \cdot f_2,$$

where the square root function is analytic for $|X_1| < 1$. Hence f_1 and f_2 are analytic there, and the local branches can be defined as the zero sets of the two irreducible analytic factors.

This is a first example of the fact that functions more general than polynomials are useful for the local study of algebraic curves. Which functions to choose depend on the point of view. It has become common practice in algebraic geometry to take more general fields than \mathbb{C} as ground field, because then problems in number theory can also be solved. To go in this direction it is appropriate to admit formal power series instead of polynomials. A nice treatment can be found in Walker's book [Wa], which has become a classic.

Here the field \mathbb{C} and the geometric properties are emphasized, and the algebra is more of a tool. In this case, analytic functions are the natural generalization of polynomials. Our first objective along the way to the local properties of curves is the *Weierstrass preparation theorem*, and there are many approaches to it (see [G-R1], I §4). Let us point out two that are particularly noteworthy.

If analytic functions are regarded as holomorphic (i.e. complex-differentiable) and the basic integral formulas are proved for them, then Weierstrass's theorem can be obtained very quickly by Stickelberger's proof [St] (see [Ko1], §1.1, for instance). Whoever prefers this approach can rejoin us in Section 6.11.

If the power series expansion of analytic functions is emphasized, then the proofs become rather hard but in return more direct and explicit. By far the most refined and polished proof of this kind is due to Grauert and Remmert (see [G-R1], [G-R2], and [G-F]). As a student of R. Remmert in 1962, I was very proud to be permitted to read the first drafts. I am pleased to be able to reproduce the result here.

6.2. To study plane curves, we need only power series in two variables. But it takes hardly any more effort to go directly to n variables,

where n is arbitrary. Let

$$\mathbb{C}[[X_1, \dots, X_n]] := \left\{ f = \sum_{(\nu_1, \dots, \nu_n) \in \mathbb{N}^n} a_{\nu_1, \dots, \nu_n} X_1^{\nu_1} \cdots X_n^{\nu_n} : a_{\nu_1, \dots, \nu_n} \in \mathbb{C} \right\}$$

be the *ring of formal power series* with complex coefficients. Multi-indices are used to write this gigantic sum more simply. If

$$\nu := (\nu_1, \dots, \nu_n) \in \mathbb{N}^n \quad \text{and} \quad X := (X_1, \dots, X_n),$$

let

$$|\nu| := \nu_1 + \cdots + \nu_n \quad \text{and} \quad X^\nu := X_1^{\nu_1} \cdots X_n^{\nu_n}.$$

Then

$$f = \sum_{\nu} a_{\nu} X^{\nu} \in \mathbb{C}[[X]].$$

For $d \in \mathbb{N}$, we have the *homogeneous part* of degree d ,

$$f_{(d)} := \sum_{|\nu|=d} a_{\nu} X^{\nu} \in \mathbb{C}[[X]],$$

and the *polynomial part* of degree $\leq k$,

$$f^{(k)} := \sum_{d=0}^k f_{(d)} \in \mathbb{C}[[X]].$$

For $f, g \in \mathbb{C}[[X]]$, setting

$$f + g := \sum_{d=0}^{\infty} (f_{(d)} + g_{(d)}), \quad f \cdot g := \sum_{d=0}^{\infty} \left(\sum_{k+l=d} (f_{(k)} g_{(l)}) \right)$$

gives the ring extension

$$\mathbb{C}[X_1, \dots, X_n] \subset \mathbb{C}[[X_1, \dots, X_n]].$$

Power series, in contrast to polynomials, do not have a degree, which is a global measure. But they have a local measure given by the lowest-order term. This is called the *order*.

Definition. For $f \in \mathbb{C}[[X_1, \dots, X_n]]$,

$$\text{ord } f := \begin{cases} \min \{d : f_{(d)} \neq 0\} & \text{if } f \neq 0, \\ \infty & \text{if } f = 0. \end{cases}$$

Clearly $\text{ord}(f+g) \geq \min\{\text{ord } f, \text{ord } g\}$ for all $f, g \in \mathbb{C}[[X]]$. Moreover,

$$\text{ord}(f \cdot g) = \text{ord } f + \text{ord } g.$$

Consequence. $\mathbb{C}[[X_1, \dots, X_n]]$ is an integral domain.

We can see immediately that

$$\mathfrak{m} = \{f \in \mathbb{C}[[X]] : \text{ord } f \geq 1\}$$

is the only *maximal ideal* and that

$$\mathfrak{m}^k = \{f \in \mathbb{C}[[X]] : \text{ord } f \geq k\}.$$

Remark 1. Let a sequence $(f_n)_{n \in \mathbb{N}}$ in $\mathbb{C}[[X]]$ be given. We call it *convergent to* $f \in \mathbb{C}[[X]]$ if for every k there is an N such that

$$f - f_n \in \mathfrak{m}^k \quad \text{for } n \geq N,$$

and a *Cauchy sequence* if for every k there is an N such that

$$f_m - f_n \in \mathfrak{m}^k \quad \text{for } m, n \geq N.$$

$\mathbb{C}[[X]]$ has the following properties:

- a) $\bigcap_{k \in \mathbb{N}} \mathfrak{m}^k = \{0\}$.
- b) Every Cauchy sequence in $\mathbb{C}[[X]]$ is convergent.

The simple *proof* is left as an exercise for the reader. This type of convergence of a sequence of power series is also called *formal convergence*, or convergence in the *Krull topology*. It is important for controlling recursive processes in the construction of a formal power series. Note that \mathbb{C} can be replaced here by an arbitrary field. This type of convergence of a sequence of series has absolutely nothing to do with the convergence of a series in the sense of Section 6.3.

Remark 2. For $f \in \mathbb{C}[[X]]$, the following conditions are equivalent:

- a) f is a unit.
- b) $\text{ord } f = 0$.
- c) $f \notin \mathfrak{m}$.

Proof. The equivalence of (b) and (c) is trivial, as is the implication (a) \Rightarrow (b).

Let $f = \sum a_\nu X^\nu$, where $a_{0\dots 0} \neq 0$; we can assume that $a_{0\dots 0} = 1$ and set $g := 1 - f$. The series

$$h := 1 + g + g^2 + \dots \in \mathbb{C}[X]$$

converges in the Krull topology because $\text{ord } g > 0$, and f is a unit because

$$f \cdot h = (1 - g)(1 + g + g^2 + \dots) = 1. \quad \square$$

6.3. The convergence of a formal series is studied by substituting special values $(x_1, \dots, x_n) \in \mathbb{C}^n$ for the variables X_1, \dots, X_n and adding the summands in any order.

Example. The geometric series $\sum X_1^{\nu_1} \dots X_n^{\nu_n}$ is absolutely convergent for $|x_\nu| < 1$, and

$$\sum_\nu x_1^{\nu_1} \dots x_n^{\nu_n} = \frac{1}{(1 - x_1) \dots (1 - x_n)}.$$

The *proof* is left as an exercise for the reader (induction on n).

This formula yields the following fundamental result.

Abel's lemma. Let $f = \sum a_\nu X^\nu$, $x = (x_1, \dots, x_n) \in \mathbb{C}^n$, and $M \in \mathbb{R}$ be given, where $x_j \neq 0$ for all j and

$$|a_\nu x^\nu| \leq M \quad \text{for all } \nu = (\nu_1, \dots, \nu_n).$$

If $0 < \varrho_j < |x_j|$, then f is uniformly and absolutely convergent in the polydisk

$$D = \{z \in \mathbb{C}^n : |z_j| \leq \varrho_j\}.$$

In particular, the limit of the sum is independent of the order of summation.

Proof. Let $\vartheta_j := \varrho_j / |x_j|$. Then $0 < \vartheta_j < 1$, and

$$\sum |a_\nu z^\nu| \leq \sum |a_\nu x^\nu| \vartheta \leq \frac{M}{(1 - \vartheta_1) \dots (1 - \vartheta_n)}$$

for $|z_j| \leq \varrho_j = \vartheta_j |x_j|$. □

Corollary. For $f = \sum a_\nu X^\nu \in \mathbb{C}[[X]]$, the following conditions are equivalent:

- i) There exists $x \in \mathbb{C}^n$, with $x_j \neq 0$ for all j , such that $\sum a_\nu x^\nu$ converges.
- ii) There exists $\varrho = (\varrho_1, \dots, \varrho_n) \in \mathbb{R}^n$, with $\varrho_j > 0$, such that $\sum a_\nu \varrho^\nu$ converges.
- iii) There exists $\sigma = (\sigma_1, \dots, \sigma_n) \in \mathbb{R}^n$, with $\sigma_j > 0$, such that $\sum |a_\nu| \sigma^\nu$ converges.

Proof. (i) \Rightarrow (ii) \Rightarrow (iii) follows from Abel's lemma, because the summands of a convergent series are bounded. (iii) \Rightarrow (i) is trivial. \square

6.4. It can be shown that within its domain of convergence a power series represents a holomorphic (i.e. complex-differentiable) function and, conversely, that any holomorphic function can be expanded locally in a power series. The proof is similar to the proof for one complex variable (see [G-F], for example). It follows easily that the convergent power series form a ring. We will use power-series methods to prove this directly. The proof, following Grauert-Remmert [G-R1], is very elegant.

Definition. A formal power series is called *convergent* if it satisfies one of the conditions of the corollary above.

The set of convergent power series is denoted by

$$\mathbb{C}\langle X_1, \dots, X_n \rangle \subset \mathbb{C}[[X_1, \dots, X_n]].$$

Note that the series in $\mathbb{C}\langle X \rangle$ do not have a common domain of convergence.

Let $\varrho = (\varrho_1, \dots, \varrho_n) \in \mathbb{R}^n$, where $\varrho_j > 0$. Consider the map

$$\mathbb{C}[[X_1, \dots, X_n]] \rightarrow \mathbb{R}_+ \cup \{\infty\}, \quad f = \sum a_\nu X^\nu \mapsto \|f\|_\varrho := \sum |a_\nu| \varrho^\nu.$$

Proposition 1. Let $f, g \in \mathbb{C}[[X]]$ and $\lambda \in \mathbb{C}$.

- a) $\|f\|_\varrho = 0 \iff f = 0$.
- b) $\|\lambda f\|_\varrho = |\lambda| \cdot \|f\|_\varrho$.

c) $\|f + g\|_\rho \leq \|f\|_\rho + \|g\|_\rho.$

d) If $f = \sum_{d=0}^{\infty} f_{(d)}$ is the decomposition into homogeneous parts, then

$$\|f\|_\rho = \sum_{d=0}^{\infty} \|f_{(d)}\|_\rho.$$

e) If f and g are polynomials, then $\|f \cdot g\|_\rho \leq \|f\|_\rho \cdot \|g\|_\rho.$

Proposition 2. For $f \in \mathbb{C}\langle X \rangle$, $\lim_{\rho \rightarrow 0} \|f\|_\rho = |f(0)|.$

The proofs of both propositions are easy exercises. Now let

$$B_\rho := \{f \in \mathbb{C}\llbracket X \rrbracket : \|f\|_\rho < \infty\}.$$

By the definition of convergence, $B_\rho \subset \mathbb{C}\langle X \rangle$. For $f = \sum a_\nu X^\nu \in B_\rho$, it is clear that

$$|a_\nu| \leq \frac{\|f\|_\rho}{\rho^\nu} \quad (\text{Cauchy's estimate}).$$

Theorem. B_ρ is a Banach algebra. Moreover,

a) If $\rho \leq \rho'$, then $B_{\rho'} \subset B_\rho.$

b) $\bigcup_\rho B_\rho = \mathbb{C}\langle X \rangle.$

Corollary 1. $\mathbb{C}\langle X \rangle \subset \mathbb{C}\llbracket X \rrbracket$ is a subring.

Proof. For $f, g \in \mathbb{C}\langle X \rangle$, there is a ρ such that $f, g \in B_\rho$. Since $f + g$ and $f \cdot g$ are in B_ρ , the assertion follows. \square

Corollary 2. Let $f \in \mathbb{C}\langle X \rangle$. If f is a unit in $\mathbb{C}\llbracket X \rrbracket$, then f is also a unit in $\mathbb{C}\langle X \rangle$. In particular,

$$f \text{ is a unit in } \mathbb{C}\langle X \rangle \iff f(0) \neq 0.$$

Proof. As in Remark 2 of Section 6.2, let $f(0) = 1$ and $g := 1 - f$. Since $g(0) = 0$, Remark 2 implies that $\theta := \|g\|_\rho < 1$ for some $\rho > 0$. It follows from

$$\|h\|_\rho \leq \sum_\nu \theta^\nu = \frac{1}{1 - \theta}$$

that $f^{-1} = h \in B_\rho \subset \mathbb{C}\langle X \rangle$. \square

Proof of the theorem. B_ρ is a normed vector space by (a), (b), and (c) of Proposition 1. To show that it is a normed algebra, we decompose $f, g \in B_\rho$ into homogeneous parts:

$$f = \sum_{k=0}^{\infty} f_{(k)}, \quad g = \sum_{l=0}^{\infty} g_{(l)}.$$

Then

$$f \cdot g = \sum_d h_{(d)}, \quad \text{where } h_{(d)} = \sum_{k+l=d} f_{(k)}g_{(l)}.$$

Hence

$$\begin{aligned} \|f \cdot g\| &= \sum_d \|h_{(d)}\| \leq \sum_d \sum_{k+l=d} \|f_{(k)}\| \cdot \|g_{(l)}\| \\ &= \left(\sum_k \|f_{(k)}\| \right) \cdot \left(\sum_l \|g_{(l)}\| \right) = \|f\| \cdot \|g\|, \end{aligned}$$

by (d) and (e). In particular, this implies the ring property of B_ρ . It remains to show that B_ρ is complete. Let

$$f_j := \sum a_\nu^{(j)} X^\nu, \quad \text{where } j \in \mathbb{N} \text{ is a Cauchy sequence in } B_\rho.$$

It follows from Cauchy's estimate that the sequence of coefficients $(a_\nu^{(j)})_{j \in \mathbb{N}}$ is a Cauchy sequence in \mathbb{C} for every multi-index ν . Let

$$f := \sum a_\nu X^\nu, \quad \text{where } a_\nu = \lim_j a_\nu^{(j)} \in \mathbb{C}.$$

It must be shown that $f \in B_\rho$ and $f = \lim_j f_j$. For $\varepsilon > 0$ there is a j_0 such that

$$\sum_\nu |a_\nu^{(j+i)} - a_\nu^{(j)}| \rho^\nu = \|f_{j+1} - f_j\| < \frac{\varepsilon}{2} \quad \text{for } j \geq j_0 \text{ and } i \geq i_0.$$

For $s \in \mathbb{N}$ there is an i_0 such that

$$\sum_{|\nu|=0}^s |a_\nu - a_\nu^{(j+i)}| \rho^\nu < \frac{\varepsilon}{2} \quad \text{for } j \geq j_0 \text{ and } i \geq i_0.$$

Hence

$$\begin{aligned} \sum_{|\nu|=0}^s |a_\nu - a_\nu^{(j)}| \rho^\nu &\leq \sum_{|\nu|=0}^s |a_\nu - a_\nu^{(j+1)}| \rho^\nu + \sum_{|\nu|=0}^s |a_\nu^{(j+1)} - a_\nu^{(j)}| \rho^\nu \\ &< \frac{\varepsilon}{2} + \frac{\varepsilon}{2} = \varepsilon. \end{aligned}$$

This holds for all s , so

$$\|f - f_j\| = \sum_{\nu} |a_{\nu} - a_{\nu}^{(j)}| \varrho^{\nu} \leq \varepsilon \quad \text{for } j \geq j_0.$$

Since

$$\|f\| \leq \|f - f_{j_0}\| + \|f_{j_0}\| \leq \varepsilon + \|f_{j_0}\| < \infty,$$

it follows that $f \in B_{\varrho}$. \square

Note that convergence in the sense of the norm on the Banach algebra B_{ϱ} is not comparable with formal convergence in the sense of the Krull topology of Section 6.2.

6.5. We can substitute other polynomials for the variables in a polynomial: If $g_1, \dots, g_n \in \mathbb{C}[Y_1, \dots, Y_m]$, then

$$\begin{aligned} \Phi_g : \mathbb{C}[X_1, \dots, X_n] &\longrightarrow \mathbb{C}[Y_1, \dots, Y_m], & X_j &\longmapsto g_j, \\ f &\longmapsto \Phi_g(f) = f(g_1(Y), \dots, g_n(Y)) =: f(g) \end{aligned}$$

defines a homomorphism of \mathbb{C} -algebras. This is not always true of power series. For instance,

$$\mathbb{C}[X] \longrightarrow \mathbb{C}[Y], \quad X \longmapsto 1,$$

does not give a map because for $f = \sum X^n$ the “series” $1 + 1 + \dots$ does not converge formally. But we do have the following theorem.

Theorem. For $g_1, \dots, g_n \in \mathbb{C}[Y_1, \dots, Y_m]$, where $\text{ord } g_j \geq 1$, there is a \mathbb{C} -algebra homomorphism

$$\overline{\Phi}_g : \mathbb{C}[X_1, \dots, X_n] \longrightarrow \mathbb{C}[Y_1, \dots, Y_m], \quad f \longmapsto f(g),$$

(called the substitution homomorphism) with the following properties:

- 1) If g_1, \dots, g_n are polynomials, then $\overline{\Phi}_g$ is an extension of Φ_g .
- 2) If g_1, \dots, g_n are convergent, then

$$\overline{\Phi}_g(\mathbb{C}\langle X_1, \dots, X_n \rangle) \subset \mathbb{C}\langle Y_1, \dots, Y_m \rangle.$$

Proof. To define $f(g) = \overline{\Phi}_g(f)$, we consider (in the notation of Section 6.1) the polynomial part $f^{(k)}$ of $f \in \mathbb{C}[X]$. Then

$$f^{(k)}(g) := f^{(k)}(g_1, \dots, g_n) \in \mathbb{C}[Y].$$

If $0 \leq k < l$, then $\text{ord}(f^{(l)} - f^{(k)}) \geq k + 1$, so

$$\text{ord}\left(f^{(l)}(g) - f^{(k)}(g)\right) \geq k + 1$$

because $\text{ord } g_j \geq 1$. Thus $(f^{(k)}(g))$ is a Cauchy sequence in the Krull topology on $\mathbb{C}[[Y]]$, and we can define

$$f(g) := \lim_{k \rightarrow \infty} f^{(k)}(g).$$

Of the properties asserted for this map $\bar{\Phi}_g$, only (2) requires some care.

It suffices to prove the following: For $\varrho = (\varrho_1, \dots, \varrho_n) \in \mathbb{R}^n$, where $\varrho_j > 0$, there exists $\sigma = (\sigma_1, \dots, \sigma_m) \in \mathbb{R}^m$ such that $\sigma_i > 0$ and

$$\bar{\Phi}_g(B_\varrho) \subset B_\sigma \subset \mathbb{C}[[Y]].$$

Since $g_j(0) = 0$, for every j there also exists $\sigma(j) \in \mathbb{R}^m$ such that $\|g_j\|_{\sigma(j)} \leq \varrho_j$. Hence there exists σ such that $\sigma_i > 0$ and

$$\|g_j\|_\sigma \leq \varrho_j \quad \text{for } j = 1, \dots, n.$$

This has the desired property, because for $f = \sum a_\nu X^\nu$ we have

$$\begin{aligned} \|f^{(k)}(g)\|_\sigma &= \left\| \sum_{d=0}^k f_{(d)}(g) \right\|_\sigma \\ &\leq \sum_{d=0}^k \|f_{(d)}(g)\|_\sigma \\ &\leq \sum_{d=0}^k \sum_{|\nu|=d} |a_\nu| \cdot \|g_1\|_\sigma^{\nu_1} \cdots \|g_n\|_\sigma^{\nu_n} \\ &\leq \sum_{d=0}^k \sum_{|\nu|=d} |a_\nu| \cdot \varrho_1^{\nu_1} \cdots \varrho_n^{\nu_n} \\ &= \|f^{(k)}\|_\varrho. \end{aligned}$$

Thus $\|f(g)\|_\sigma = \lim_{k \rightarrow \infty} \|f^{(k)}(g)\|_\sigma \leq \lim_{k \rightarrow \infty} \|f^{(k)}\|_\varrho = \|f\|_\varrho$. \square

In the special case $m = n$, there is some chance that $\bar{\Phi}_g$ will be an isomorphism. We will return to this when we discuss the implicit function theorem in Section 6.9.

6.6. In the preparation theorem, one variable is set apart. We begin with some preliminary remarks. A series $f \in \mathbb{C}[[X_1, \dots, X_n]]$ can be expanded in terms of X_n :

$$f = \sum_{j=0}^{\infty} f_j X_n^j, \quad \text{where } f_j \in \mathbb{C}[[X_1, \dots, X_{n-1}]].$$

If $\varrho \in (\varrho_1, \dots, \varrho_n) \in \mathbb{R}^n$ and $\varrho' = (\varrho_1, \dots, \varrho_{n-1})$, then

$$\|f\|_{\varrho} = \sum_{j=0}^{\infty} \|f_j\|_{\varrho'} \varrho_n^j.$$

Hence if f converges, so do all the f_j . We start by considering what happens if we set $X_1 = \dots = X_{n-1} = 0$.

Definition. Let $f \in \mathbb{C}[[X_1, \dots, X_n]]$ and

$$\bar{f}(X_n) := f(0, \dots, 0, X_n) \in \mathbb{C}[[X_n]].$$

f is called *general in X_n* if $\bar{f} \neq 0$, and *general in X_n of order k* if

$$\text{ord } \bar{f} = k, \quad \text{i.e. } \bar{f} = b_k X_n^k + \dots, \quad \text{where } b_k \neq 0.$$

Clearly $\text{ord } f \leq \text{ord } \bar{f} = \min\{j : f_j(0) \neq 0\}$ if $f = \sum f_j X_n^j$.

Lemma. If $0 \neq f \in \mathbb{C}[[X_1, \dots, X_n]]$, where $k := \text{ord } f$, then there is a shear

$$\begin{aligned} X_i &= Y_i + c_i Y_n & \text{if } i = 1, \dots, n-1, \\ X_n &= Y_n, \end{aligned}$$

such that

$$g(Y) = f(X(Y)) \in \mathbb{C}[[Y_1, \dots, Y_n]]$$

is general in Y_n of order k . The series g is convergent if and only if f is convergent.

Proof. Let

$$f_{(d)} = \sum_{|\nu|=d} a_{\nu_1 \dots \nu_n} X_1^{\nu_1} \dots X_n^{\nu_n}.$$

Since the shear is linear, $g_{(d)} = f_{(d)}(X(Y))$. For $d = k$, in particular,

$$\begin{aligned} g_{(k)} &= \sum_{|\nu|=k} a_{\nu_1 \dots \nu_n} (Y_1 + c_1 Y_n)^{\nu_1} \dots (Y_{n-1} + c_{n-1} Y_n)^{\nu_{n-1}} Y_n^{\nu_n} \\ &= \left(\sum a_{\nu_1 \dots \nu_n} c_1^{\nu_1} \dots c_{n-1}^{\nu_{n-1}} \right) Y_n^k + h(Y), \end{aligned}$$

where $h(0, \dots, 0, Y_n) = 0$. The coefficient of Y_n^k is a polynomial in c_1, \dots, c_{n-1} , which is not identically zero because $f_{(k)} \neq 0$. Hence c_1, \dots, c_{n-1} can be chosen so that the coefficient does not vanish. The convergence statement follows from Section 6.5. \square

Of special interest is the case where only finitely many summands appear in the expansion in terms of X_n :

$$f \in \mathbb{C}\langle X_1, \dots, X_{n-1} \rangle[X_n], \quad f = f_0 + f_1 X_n + \dots + f_k X_n^k.$$

In this case, the coefficients f_j have a common radius of convergence ϱ' , so they are holomorphic in

$$D' = \{x' = (x_1, \dots, x_{n-1}) \in \mathbb{C}^{n-1} : |x_i| < \varrho_i\}.$$

Hence f is holomorphic in $D' \times \mathbb{C}$, and indeed in a special way: for fixed $x' \in D'$, f is a polynomial of degree $\leq k$. Hence f has at most k zeros for fixed x' .

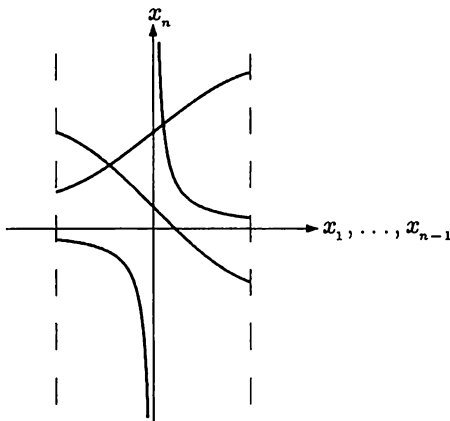

Figure 6.2. Zeros of a polynomial $f \in \mathbb{C}\langle X_1, \dots, X_{n-1} \rangle[X_n]$

Definition. Let $f \in \mathbb{C}\langle X_1, \dots, X_{n-1} \rangle[X_n]$, $f = \sum_{j=0}^k f_j X_n^j$, $f_k \neq 0$. f is called a *Weierstrass polynomial* if

$$f_0(0) = \dots = f_{k-1}(0) = 0, \quad f_k = 1.$$

Thus, for $x' = 0$, the zeros of a Weierstrass polynomial are concentrated with multiplicity k at $X_n = 0$. Since f has degree k for each fixed x' , it has k zeros.

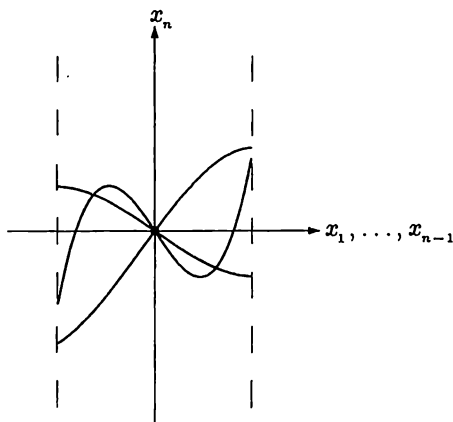

Figure 6.3. Zeros of a Weierstrass polynomial

6.7. Now we have finished the preliminaries and can formulate the main result.

Weierstrass preparation theorem. *Let $g \in \mathbb{C}\langle X_1, \dots, X_n \rangle$ be general in X_n of order k . Then there is exactly one representation*

$$\begin{aligned} g &= \alpha \cdot p \\ &= \alpha(X_1, \dots, X_n) \cdot (X_n^k + a_1(X_1, \dots, X_{n-1})X_n^{k-1} + \dots \\ &\quad + a_k(X_1, \dots, X_{n-1})), \end{aligned}$$

where $\alpha \in \mathbb{C}\langle X_1, \dots, X_n \rangle$ is a unit and $p \in \mathbb{C}\langle X_1, \dots, X_{n-1} \rangle[X_n]$ is a Weierstrass polynomial of degree k (i.e. $a_i(0) = 0$ for $i = 1, \dots, k$).

Complement. *If g is in $\mathbb{C}\langle X_1, \dots, X_{n-1} \rangle[X_n]$, then so is α .*

Thus, in some neighborhood of the origin, the zeros of g are the same as those of the Weierstrass polynomial p . The size of this neighborhood cannot be predicted, because it is unclear how far away

from 0 the power series converges or how close to 0 the function α has zeros. (We know for certain only that $\alpha(0) \neq 0$.)

The relationship between g and k can be seen from Section 6.6: ord $g \leq k$ in each case, and equality holds in suitable coordinates. Moreover, if g itself is a polynomial, then

$$k \leq \deg_{X_n} g,$$

and in general the degree of g is larger. You should make it clear to yourself how this is connected to the distribution of the zeros. Even for $g \in \mathbb{C}\langle X_1, \dots, X_n \rangle$, the preparation theorem makes an important statement about the behavior at the origin. We will apply this later, in the case $n = 2$, to the local study of algebraic curves.

To prove the preparation theorem, we use its twin sister, the Weierstrass division theorem.

Weierstrass division theorem. *Let $f, g \in \mathbb{C}\langle X_1, \dots, X_n \rangle$ and let g be general in X_n of order k . Then there exist $q \in \mathbb{C}\langle X_1, \dots, X_n \rangle$ and $r \in \mathbb{C}\langle X_1, \dots, X_{n-1} \rangle[X_n]$ such that $\deg_{X_n} r \leq k - 1$ and*

$$f = q \cdot g + r.$$

These conditions determine q and r uniquely.

In particular, if $f, g \in \mathbb{C}\langle X_1, \dots, X_{n-1} \rangle[X_n]$ and

$$g = g_0 + g_1 X_n + \cdots + g_k X_n^k, \quad \text{where } g_k(0) \neq 0,$$

then g_k is a unit in the ring $\mathbb{C}\langle X_1, \dots, X_{n-1} \rangle$, and the classical division theorem in polynomial rings even gives $q \in \mathbb{C}\langle X_1, \dots, X_{n-1} \rangle[X_n]$. Thus the Weierstrass formula is an analogue of this classical formula from elementary algebra.

The preparation theorem and the division theorem hold in exactly the same way with \mathbb{R} instead of \mathbb{C} . One way of seeing this is to observe that the following proof uses only the complete valuation of \mathbb{C} .

An analogue of the preparation theorem is valid for formal power series over an arbitrary field K . This can be proved by completely elementary means, using a careful comparison of coefficients. But it can also be proved with the methods of Section 6.8, by way of the following exercise.

Exercise. Let K be an arbitrary field with the *trivial valuation*

$$|a| = \begin{cases} 0 & \text{if } a = 0, \\ 1 & \text{otherwise.} \end{cases}$$

As in Section 6.4, let

$$\|f\|_{\varrho} := \sum |a_{\nu}| \varrho^{\nu} \leq \infty \quad \text{and} \quad B_{\varrho} := \{f \in K[[X]] : \|f\|_{\varrho} < \infty\}$$

for $f \in K[[X]]$ and $\varrho = (\varrho_1, \dots, \varrho_n) \in \mathbb{R}^n$, where $\varrho_i > 0$.

Prove:

- a) $\|\cdot\|$ is a norm on B_{ϱ} . (See the proposition in Section 6.4.)
- b) $\|f \cdot g\|_{\varrho} \leq \|f\|_{\varrho} \cdot \|g\|_{\varrho}$ for $f, g \in B_{\varrho}$.
- c) Every Cauchy sequence in B_{ϱ} converges.
- d) $B_{\varrho'} \subset B_{\varrho}$ for $\varrho \leq \varrho'$, and $\bigcup_{\varrho} B_{\varrho} = K[[X]]$.
- e) If $g = \sum X^{\nu}$ is the geometric series, then $\|f\|_{\varrho} \leq \|g\|_{\varrho}$ for all f and ϱ .
- f) If $0 < \varrho_j < 1$ for all j , then $B_{\varrho} = K[[X]]$.
- g) $h \in K[[X]]$ is a unit if and only if $\text{ord } h = 0$.
- h) If $\text{ord } h \geq 1$, then $\lim_{\varrho \rightarrow 0} \|h\|_{\varrho} = 0$.

6.8. In this section we will prove everything that was asserted and explained in Section 6.7. The following abbreviations will be used:

$$\begin{aligned} X' &:= (X_1, \dots, X_{n-1}), \\ X &:= (X_1, \dots, X_n), \\ A' &:= \mathbb{C}\langle X' \rangle \subset A := \mathbb{C}\langle X \rangle. \end{aligned}$$

With this notation, Weierstrass's theorems take place in the rings

$$A' \subset A'[X_n] \subset A.$$

As an appetizer, we offer the *proof of the complement*. Let $g \in A'[X_n]$, where $g = \alpha \cdot p$, $\alpha \in A$, be the factorization given by the preparation theorem. Since p is normalized, we can divide in $A'[X_n]$ with a remainder:

$$g = qp + r, \quad q, r \in A'[X_n], \quad \text{deg } r < k.$$

By uniqueness, this is the factorization given by the Weierstrass division theorem; another is

$$g = \alpha p + 0.$$

Thus $r = 0$ and $\alpha = q \in A'[X_n]$. \square

Proof of the preparation theorem from the division theorem. We divide $f = X_n^k$ by the given g :

$$X_n^k = q \cdot g + \sum_{i=1}^k a_i X_n^{k-i}, \quad \text{where } a_i \in A'.$$

Written differently, this says that

$$q \cdot g = X_n^k - \sum_{i=1}^k a_i X_n^{k-i}.$$

We substitute $X_1 = \cdots = X_{n-1} = 0$:

$$q(0, X_n) \cdot (cX_n^k + \cdots) = X_n^k - \sum_{i=1}^k a_i(0) X_n^{k-i}, \quad \text{where } c \neq 0.$$

Comparing the coefficients of X_n^l gives

$$q(0, 0) = \frac{1}{c} \neq 0 \quad \text{and} \quad a_1(0) = \cdots = a_k(0) = 0.$$

Thus q is a unit, and setting $\alpha = q^{-1}$ completes the proof of the existence statement of the preparation theorem.

Suppose there are two representations

$$g = \alpha \cdot p = \tilde{\alpha} \cdot \tilde{p}, \quad \text{where } p = X_n^k - r, \quad \tilde{p} = X_n^k - \tilde{r}.$$

Then

$$X_n^k = \alpha^{-1} \cdot g + r = \tilde{\alpha}^{-1} \cdot g + \tilde{r}.$$

Hence, by uniqueness in the division theorem, $\alpha = \tilde{\alpha}$ and $r = \tilde{r}$. It follows that $p = \tilde{p}$. \square

Proof of the Weierstrass division theorem. In the “classical” proof, q and r are first constructed as formal series, and convergence is proved afterwards. This is quite difficult (see [T], for instance). Here we reproduce the ingenious proof of Grauert and Remmert, which ties the formal construction and proof of convergence together ([G-R1] and [G-R2]).

We have to split several power series according to the given order k . The following notation is useful. For $f \in A$, set

$$f = \sum_{j=0}^{\infty} f_j X_n^j \quad (\text{where } f_j \in A'), \quad \widehat{f} := \sum_{j=1}^{k-1} f_j X_n^j, \quad \widetilde{f} := \sum_{j=k}^{\infty} f_j X_n^{j-k}.$$

Then $f = \widehat{f} + \widetilde{f} X_n^k$. Letting $\varrho = (\varrho_1, \dots, \varrho_n)$, it follows as in Section 6.4 that

$$\|f\|_e = \|\widehat{f}\|_e + \varrho_n^k \|\widetilde{f}\|_e; \quad \text{in particular, } \|\widetilde{f}\|_e \leq \varrho_n^{-k} \|f\|_e. \quad (1)$$

If $g = \widehat{g} + \widetilde{g} X_n^k$, then $\widehat{g} \in A$ is a unit by hypothesis. Let ϱ be chosen so that $f, g, \widetilde{g}^{-1} \in B_e$. We consider the auxiliary function

$$h := X_n^k - g\widetilde{g}^{-1} = -\widehat{g}\widetilde{g}^{-1} \in B_e,$$

and claim that for a given ϑ with $0 < \vartheta < 1$, the radius ϱ can be decreased so that

$$\|h\|_e \leq \vartheta \cdot \varrho_n^k. \quad (2)$$

By the definition of h ,

$$h = \widehat{h} + \widetilde{h} X_n^k = h_0 + h_1 X_n + \dots + h_{k-1} X_n^{k-1} + \widetilde{h} X_n^k, \quad \text{where}$$

$$h_0(0) = \dots = h_{k-1}(0) = \widetilde{h}(0) = 0.$$

Since $\widetilde{h}(0) = 0$, we can decrease ϱ so that

$$\|\widetilde{h}\|_e \leq \frac{\vartheta}{2}; \quad \text{thus } \|\widetilde{h} X_n^k\|_e \leq \frac{\vartheta}{2} \varrho_n^k. \quad (3)$$

Moreover,

$$\|\widehat{h}\|_e \leq \|h_0\|_{e'} + \|h_1\|_{e'} \varrho_n + \dots + \|h_{k-1}\|_{e'} \varrho_n^{k-1},$$

where $e' = (\varrho_1, \dots, \varrho_{n-1})$. Since $h_0(0) = \dots = h_{k-1}(0) = 0$, we can decrease ϱ' further while holding ϱ_n fixed, until

$$\|h_j\|_{e'} \leq \frac{\vartheta}{2k} \varrho_n^{k-j} \quad \text{for } j = 0, \dots, k-1; \quad \text{thus } \|\widehat{h}\|_e \leq \frac{\vartheta}{2} \varrho_n^k. \quad (4)$$

(2) follows from (3) and (4).

The function h is now used as follows: for $\varphi \in A$, we define $h(\varphi) := h \cdot \widetilde{\varphi} \in A$. By (1) and (2),

$$\|h(\varphi)\|_e \leq \|h\|_e \cdot \|\widetilde{\varphi}\|_e \leq \vartheta \|\varphi\|_e. \quad (5)$$

This lets us start an iteration:

$$\varphi_0 := f, \quad \varphi_{i+1} := h(\varphi_i) = h \cdot \tilde{\varphi}_i. \quad (6)$$

The series $\varphi := \sum_{i=0}^{\infty} \varphi_i$ converges because

$$\|\varphi\|_e \leq \sum_{i=0}^{\infty} \|\varphi_i\|_e \leq \|\varphi_0\|_e \sum_{i=0}^{\infty} \vartheta^i = \|f\|_e \frac{\vartheta}{1-\vartheta} < \infty.$$

We define

$$q := \tilde{\varphi} \tilde{g}^{-1} \in B_\varrho, \quad r := \hat{\varphi} \in B_{\varrho'}[X_n].$$

It follows from

$$\hat{\varphi} = \sum \hat{\varphi}_i, \quad \tilde{\varphi} = \sum \tilde{\varphi}_i, \quad \text{and} \quad \varphi_i - \varphi_{i+1} = g\tilde{g}^{-1}\tilde{\varphi}_i + \hat{\varphi}_i$$

that

$$f = \sum_{i=0}^{\infty} (\varphi_i - \varphi_{i+1}) = g\tilde{g}^{-1} \sum \tilde{\varphi}_i + \sum \hat{\varphi}_i = qg + r.$$

This proves *existence*. Note that in general the series $\varphi = \sum \varphi_i$ is not formally convergent (Section 6.2), so it cannot be used to compute φ recursively. Note also that no predictions can be made about the radii of convergence of q and r in terms of f and g , because (2) must hold.

To prove *uniqueness*, it suffices to show that

$$0 = qg + r \quad \text{implies} \quad q = r = 0.$$

There exists ϱ such that $q, g, r, \tilde{g}^{-1} \in B_\varrho$. For $h := X_n^k - g\tilde{g}^{-1}$, the series used above, we have

$$q\tilde{g}h = q\tilde{g}X_n^k + r. \quad (7)$$

Let the radius ϱ again be chosen so that (2) holds. Using (7) and the fact that $\deg_{X_n} r < k$ gives

$$\begin{aligned} M &:= \|q\tilde{g}\|_e \varrho_n^k = \|q\tilde{g}X_n^k\|_e \\ &\leq \|q\tilde{g}X_n^k + r\|_e = \|q\tilde{g}h\|_e \leq \|q\tilde{g}\|_e \vartheta \varrho_n^k = \vartheta M. \end{aligned}$$

Thus $M = 0$ since $0 < \vartheta < 1$, and $\|q\tilde{g}\|_e = 0$ since $\varrho_n \neq 0$. Hence $q\tilde{g} = 0$. But $\tilde{g} \neq 0$, so $q = r = 0$. \square

Exercise. Prove uniqueness in the Weierstrass preparation theorem by using the following theorem.

Theorem on the continuity of the roots. *Let*

$$D' := \{x = (x_1, \dots, x_{n-1}) \in \mathbb{C}^{n-1} : |x_i| < \rho_i\},$$

$$E := \{y \in \mathbb{C} : |y| < \rho\},$$

and let f be holomorphic in the polydisk $D' \times E$. Suppose there exists $0 < r < \rho$ such that the holomorphic functions

$$f_x : E \rightarrow \mathbb{C}, \quad y \mapsto f(x, y)$$

have no zeros in the annulus $r \leq |y| < \rho$. Then there exists $k \in \mathbb{N}$ such that for each $x \in D'$ the function f_x has exactly k zeros in E , counted with multiplicities.

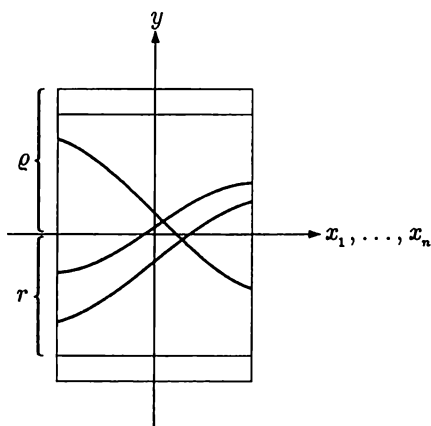

Figure 6.4. Continuity of the roots

Proof. Let $f'_x := df_x/dy$ and $r < R < \rho$, and set

$$k(x) := \frac{1}{2\pi i} \int_{|y|=R} \frac{f'_x(y)}{f_x(y)} dy \in \mathbb{N}.$$

For fixed x , $k(x)$ counts the zeros of f_x in $|y| < R$, and since $k(x)$ depends continuously on x it is constant. \square

6.9. An important special case of the preparation theorem occurs when the given series f has order $k = 1$ in the distinguished variable. In this case we change the notation slightly: let

$$f = \sum_{j=0}^{\infty} f_j Y^j \in \mathbb{C}\langle X_1, \dots, X_n, Y \rangle,$$

where $f_j \in \mathbb{C}\langle X_1, \dots, X_n \rangle$, $f(0) = 0$, and $f_1(0) \neq 0$. Then f is general in Y of order 1, and by the preparation theorem there exist a unit $\alpha \in \mathbb{C}\langle X_1, \dots, X_n, Y \rangle$ and $\varphi \in \mathbb{C}\langle X_1, \dots, X_n \rangle$ such that $\varphi(0) = 0$ and

$$f = \alpha(Y - \varphi).$$

Hence

$$f(X, \varphi(X)) = \alpha(X, \varphi(X))(\varphi(X) - \varphi(X)) = 0.$$

If $\psi \in \mathbb{C}\langle X_1, \dots, X_n \rangle$ is an arbitrary series satisfying $\psi(0) = 0$ and $f(X, \psi(X)) = 0$, then

$$0 = f(X, \psi(X)) = \alpha(X, \psi(X))(\psi(X) - \varphi(X)).$$

It follows from $\psi(0) = 0$ and $\alpha(0, 0) \neq 0$ that $\alpha(0, \psi(0)) \neq 0$. Since α and ψ are continuous, we have

$$\alpha(x, \psi(x)) \neq 0 \quad \text{and hence} \quad \psi(x) = \varphi(x)$$

in a neighborhood of $0 \in \mathbb{C}^n$. The next theorem follows from this and from the identity theorem for power series.

Implicit function theorem. Let $f \in \mathbb{C}\langle X_1, \dots, X_n, Y \rangle$, where

$$f(0) = 0 \quad \text{and} \quad \frac{\partial f}{\partial Y}(0) \neq 0.$$

Then there is exactly one series $\varphi \in \mathbb{C}\langle X_1, \dots, X_n, Y \rangle$ such that

$$\varphi(0) = 0 \quad \text{and} \quad f(X_1, \dots, X_n, \varphi(X_1, \dots, X_n)) = 0.$$

This theorem also holds in real analysis, for differentiable functions. But it is not at all obvious that the solution φ is analytic if f is. In Appendix 3 we give an explicit recursive procedure for constructing φ . In Section 7.11, Corollary 2, we prove a sharper version that is often useful.

The proof above also shows that the Weierstrass preparation theorem can be viewed as a generalization of the implicit function theorem. When $k > 1$, however, the implicit equation $f(X, Y) = 0$ can no longer be solved with an ordinary function $Y = \varphi(X)$. We need a “ k -valued function” instead. This is the topic of Chapter 7.

One way of proving the following theorem is by induction on m , with the theorem above as the first step of the induction (see [A], for instance).

Theorem on systems of implicit functions. *Let*

$$f_1, \dots, f_m \in \mathbb{C}\langle X_1, \dots, X_n, Y_1, \dots, Y_m \rangle$$

be given, with

$$f_i(0) = 0 \quad \text{and} \quad \det \left(\frac{\partial f_i}{\partial Y_j}(0) \right) \neq 0.$$

Then there is exactly one system $\varphi_1, \dots, \varphi_m \in \mathbb{C}\langle X_1, \dots, X_n \rangle$ such that $\varphi(0) = 0$ and

$$f_i(X, \varphi_1(X), \dots, \varphi_m(X)) = 0.$$

Corollary. *Let $g_1, \dots, g_n \in \mathbb{C}\langle Y_1, \dots, Y_n \rangle$ be given, with $g_i(0) = 0$ and*

$$\det \left(\frac{\partial g_i}{\partial Y_j}(0) \right) \neq 0.$$

Then the substitution homomorphism

$$\mathbb{C}\langle X_1, \dots, X_n \rangle \rightarrow \mathbb{C}\langle Y_1, \dots, Y_n \rangle, \quad f(X_1, \dots, X_n) \mapsto f(g_1, \dots, g_n),$$

of Section 6.5 is an isomorphism.

This corresponds to the Jacobian criterion for local diffeomorphisms in real analysis. The *proof* of the corollary from the theorem above is recommended to the reader as an exercise.

6.10. For a later application, we need another statement about the zeros of a polynomial that has holomorphic coefficients but is not necessarily a Weierstrass polynomial. We use the notation

$$\bar{f}(Y) := f(0, Y) \in \mathbb{C}[Y],$$

where $A := \mathbb{C}\langle X_1, \dots, X_n \rangle$ and $f = a_0 Y^k + a_1 Y^{k-1} + \dots + a_k \in A[Y]$.

Hensel's lemma. Let $f \in A[Y]$ be normalized (i.e. $a_0 = 1$), and let

$$\bar{f} = (Y - c_1)^{k_1} \cdot \dots \cdot (Y - c_r)^{k_r},$$

where the $c_\rho \in \mathbb{C}$ are distinct. Then there are normalized polynomials $f_1, \dots, f_r \in A[Y]$ such that

$$f = f_1 \cdot \dots \cdot f_r, \quad \deg f_\rho = k_\rho, \quad \text{and} \quad \bar{f}_\rho = (Y - c_\rho)^{k_\rho} \text{ for } \rho = 1, \dots, r.$$

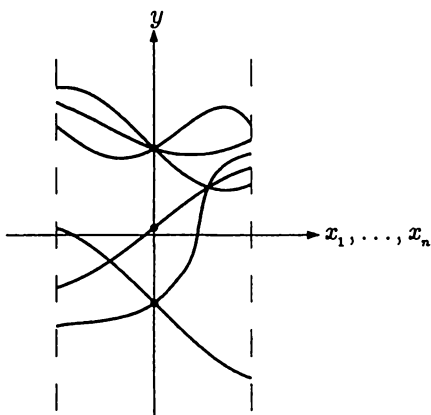

Figure 6.5. For Hensel's lemma

Proof. The existence of f_1, \dots, f_r follows from repeated applications of the preparation theorem. We proceed by induction on r . For $r = 1$, set $f_1 = f$.

If $r > 1$, we apply a change of coordinates sending c_r to zero. Let

$$g(X, Y) := f(X, Y + c_r) \in A[Y].$$

This polynomial is general in Y of order k_r . By the preparation theorem and its complement (Section 6.7),

$$g = \alpha \cdot p,$$

where $\alpha, p \in A[Y]$ and $\deg p = k_r$. We set

$$f^*(Y) := \alpha(Y - c_r), \quad f_r(Y) := p(Y - c_r).$$

Then f_r is normalized, $f = f^* \cdot f_r$, and

$$\overline{f^*} = (Y - c_1)^{k_1} \cdots (Y - c_{r-1})^{k_{r-1}}.$$

The existence of f_1, \dots, f_{r-1} follows by applying the induction hypothesis to f^* . \square

Complement. It can also be shown that the f_ρ are uniquely determined and pairwise relatively prime (see [G-R1]).

6.11. We can now use the preparation theorem to transfer the known divisibility theory in the ring of polynomials to power series. As a geometric application, we then obtain the local decomposition of a curve into “branches.”

Theorem. *The ring $\mathbb{C}\langle X_1, \dots, X_n \rangle$ of convergent power series is a unique factorization domain.*

We use the same notation as before:

$$X' = (X_1, \dots, X_{n-1}), \quad A' = \mathbb{C}\langle X' \rangle, \quad A = \mathbb{C}\langle X_1, \dots, X_n \rangle.$$

To set up an argument by induction on n , we use the intermediate ring

$$A' \subset A'[X_n] \subset A.$$

But we have to be very careful in divisibility arguments because the units in these rings are different. For instance, $1 - X_n$ is a unit in A (geometric series) but not in $A'[X_n]$. We begin by observing that the Weierstrass polynomials $p \in A'[X_n]$, i.e. polynomials

$$p = X_n^k + a_1 X_n^{k-1} + \cdots + \tilde{a}_k, \quad \text{where } k \in \mathbb{N}, a_i \in \mathfrak{m}' \subset A',$$

are especially well behaved under ring extension.

Proposition 1. *For a Weierstrass polynomial $p \in A'[X_n]$, the following conditions are equivalent:*

- a) $k = 0$, i.e. $p = 1$.
- b) p is a unit in $A'[X_n]$.
- c) p is a unit in A .

The *proof* is very easy.

Proposition 2. Let $f = g \cdot h$ in $A'[X_n]$. Then

- a) if g and h are Weierstrass polynomials, so is f ;
- b) if f is a Weierstrass polynomial, there exist units $\lambda, \mu \in A'$ such that λg and μh are Weierstrass polynomials.

Proof. (a) is clear. To prove (b), we write

$$g = b_0 X_n^l + \cdots + b_l, \quad \text{where } b_i \in A',$$

$$h = c_0 X_n^m + \cdots + c_m, \quad \text{where } c_j \in A'.$$

Since $b_0 \cdot c_0 = 1$, we can choose $\lambda := c_0$ and $\mu := b_0$. Setting $X' = 0$ in $f = (\lambda g)(\mu h)$ gives

$$b_1, \dots, b_l, c_1, \dots, c_m \in m'. \quad \square$$

Lemma. For a Weierstrass polynomial $p \in A'[X_n]$, the following are equivalent:

- a) p is irreducible in $A'[X_n]$.
- b) p is irreducible in A .

Proof. (a) \Rightarrow (b): Let p be reducible in A , i.e. $p = f_1 \cdot f_2$, where $f_i \in A$ are nonunits and we may assume they are general in X_n . By the preparation theorem,

$$f_i = \alpha_i q_i, \quad \text{so } p = (\alpha_1 \alpha_2) q_1 q_2.$$

Since $q_1 q_2$ is a Weierstrass polynomial, uniqueness gives $\alpha_1 \alpha_2 = 1$; hence $p = q_1 q_2$. Suppose one of the $q_i \in A'[X_n]$ is a unit. Then $q_i = 1$ and $f_i = \alpha_i$, contradicting the hypothesis.

(b) \Rightarrow (a): Let p be reducible in $A'[X_n]$, i.e. $p = p_1 p_2$, where we may assume by Proposition 2 that p_1 and p_2 are Weierstrass polynomials of degree k_i . Then $k_i \geq 1$ by Proposition 1, so p is reducible in A . \square

The *proof of the theorem* is by induction on n . For $n = 0$ there is nothing to prove because \mathbb{C} is a unique factorization domain. By the

induction hypothesis we may assume that A' is a unique factorization domain. Then $A'[X_n]$ is also a unique factorization domain by Gauss's theorem.

Now we show that every $f \in A$ admits a factorization into irreducible elements, unique up to order and units. We may assume that f is general in X_n . By the preparation theorem,

$$f = \alpha \cdot p,$$

where $\alpha \in A$ is a unit and $p \in A'[X_n]$ is a Weierstrass polynomial. Since $A'[X_n]$ is a unique factorization domain, there is a factorization

$$p = p_1 \cdot \dots \cdot p_r$$

into irreducible elements, which is unique up to the order in which the factors occur once p_1, \dots, p_r have been normalized to be Weierstrass polynomials (Proposition 2 b)). By the lemma,

$$f = \alpha p_1 \cdot \dots \cdot p_r$$

is a factorization of f into irreducible elements. If

$$f = f_1 \cdot \dots \cdot f_s$$

is another such factorization in A , then f_1, \dots, f_s can be represented in appropriate coordinates as

$$f_1 = \alpha_1 \cdot q_1, \dots, f_s = \alpha_s \cdot q_s,$$

where $\alpha_1, \dots, \alpha_s \in A$ are units and q_1, \dots, q_s are Weierstrass polynomials. By uniqueness in the preparation theorem, it follows that

$$p_1 \cdot \dots \cdot p_r = q_1 \cdot \dots \cdot q_s.$$

Since $A'[X_n]$ is a unique factorization domain, $r = s$ and $p_i = q_i$ up to the order in which they occur. Thus $f_i = \alpha_i \cdot p_i$, as was to be shown. \square

Exercise 1. Prove by induction on $\text{ord } f$ (see Section 6.2) that every $f \in A$ has a factorization into irreducible elements. Also prove by induction on n , using the preparation theorem, that every irreducible element in A is prime. This gives a somewhat different proof that A is a unique factorization domain.

Exercise 2. $K[[X_1, \dots, X_n]]$ is a unique factorization domain for any field K . Use the preparation theorem for formal power series.

Another important consequence of the Weierstrass preparation theorem is the following:

Theorem. $\mathbb{C}\langle X_1, \dots, X_n \rangle$ is Noetherian.

The usual proof for the ring of polynomials carries over through the preparation theorem. In curve theory, however, this result is not needed.

6.12. Now we have all the necessary tools to transfer to power series what we proved in Chapter 1 about the zero sets of polynomials. Polynomials are functions on all of \mathbb{C}^n ; power series are functions only in neighborhoods of the origin, and the size of the neighborhood depends on the series. This requires special terminology.

Definition. Let $D = \{x = (x_1, \dots, x_n) \in \mathbb{C}^n : 0 \leq |x_i| < \rho_i\}$ be a polydisk, and let $M \subset D$. M is called a *principal analytic set* if there exists $f \in \mathbb{C}\langle X_1, \dots, X_n \rangle$ that converges throughout D and satisfies

$$M = \{x \in D : f(x) = 0\} =: V_D(f).$$

If f is a polynomial for $n = 2$, this reduces to the definition of an algebraic curve in Chapter 1. If the polynomial f is a unit in $\mathbb{C}[X_1, X_2]$, then $V(f) = \emptyset$. This is the first step in translating set-theoretic relations among varieties into the divisibility theory of polynomials. For power series, things are different: Being a unit means that $f(0) \neq 0$, hence that $0 \notin V_D(f)$. This says nothing about the behavior of $V_D(f)$ away from the origin. Still, in a smaller neighborhood $V' \subset V$ of 0 ("locally at 0"), $V_D(f)$ coincides with the empty set. This motivates the following definition.

Definition. Let $M_1 \subset D_1$ and $M_2 \subset D_2$ be principal analytic sets. M_1 and M_2 are said to be *equivalent* if there is a polydisk $D \subset D_1 \cap D_2$ such that

$$M_1 \cap D = M_2 \cap D.$$

An equivalence class of principal analytic sets is called a *germ of a principal analytic set* or, when $n = 2$, a *germ of a curve*.

To keep the notation simple we write $V(f)$ for the *germ* defined by $V_D(f) \subset D$. It is no longer a subset of a polydisk, but can be represented by a subset of a polydisk. In the same way, we define

$$V(f_1) \subset V(f_2)$$

$:\Leftrightarrow$ there are representatives $V_{D_i}(f_i)$ and $D \subset D_1 \cap D_2$ such that

$$V_{D_1}(f_1) \cap D \subset V_{D_2}(f_2) \cap D,$$

and similarly for $V(f_1) \cup V(f_2)$ and $V(f_1) \cap V(f_2)$. In particular,

$$V(f) = \emptyset \Leftrightarrow 0 \notin V_D(f) \quad \text{for some (hence any) representative.}$$

Hence $V(f) = \emptyset \Leftrightarrow f$ is a unit in $\mathbb{C}\langle X_1, \dots, X_n \rangle$, which gets the translation machinery started.

Exercise. If f is a divisor of g , then $V(f) \subset V(g)$. If $f = f_1 \cdots f_r$, then

$$V(f) = V(f_1) \cup \cdots \cup V(f_r).$$

6.13. We now give an analogue of the result in Section 1.3.

Study's lemma. *Let $f, g \in A = \mathbb{C}\langle X_1, \dots, X_n \rangle$. If f is irreducible and the germs satisfy $V(f) \subset V(g)$, then f is a divisor of g in A .*

Proof. We proceed by induction on n . The case $n = 0$ is trivial. Let $X' = (X_1, \dots, X_{n-1})$ and $A' = \mathbb{C}\langle X' \rangle$. By the preparation theorem, we may assume that f and g are Weierstrass polynomials in $A'[X_n]$, so

$$f = X_n^k + a_1 X_n^{k-1} + \cdots + a_k,$$

$$g = X_n^l + b_1 X_n^{l-1} + \cdots + b_l,$$

where $k, l \geq 1$ and $a_i, b_j \in A'$, $a_i(0) = b_j(0) = 0$. Since A' is a unique factorization domain, we can apply the resultant theorem A.1.1. Since f is also irreducible in $A'[X_n]$ (Lemma 6.11), we need only show that $R_{f,g} = 0$ in A' . Let f and g be convergent in the polydisk

$$D = \{(x_1, \dots, x_n) \in \mathbb{C}^n : 0 \leq |x_i| < \varrho_i\}.$$

Let

$$D' = \{x' = (x_1, \dots, x_{n-1}) \in \mathbb{C}^{n-1} : |x_j| < \varrho_j\}.$$

Substituting an $x' \in D'$ into f and g , we get $f_{x'}, g_{x'} \in \mathbb{C}[X_n]$. We have $f_0 = X_n^k$, $g_0 = X_n^l$, so

$$V(f_0) = V(g_0) = \{0\}.$$

Because of the continuity of the roots (Section 6.8) and the relationship $V(f) \subset V(g)$ for the germs, we can choose D such that, for $x' \in D'$, all the roots of $f_{x'}$ and $g_{x'}$ lie in $\{x_n \in \mathbb{C} : |x_n| < \varrho_n\}$ and $V(f_{x'}) \subset V(g_{x'})$. Hence $f_{x'}$ and $g_{x'}$ have a common prime factor in $\mathbb{C}[X_n]$, and therefore

$$R_{f,g}(x') = R_{f_{x'},g_{x'}} = 0 \quad \text{in } \mathbb{C}.$$

This holds for all $x' \in D'$, so $R_{f,g} = 0$ in A' by the identity theorem. \square

6.14. We now obtain the decomposition into components of a germ of a principal analytic set, exactly as we did for algebraic curves in Section 1.4.

Definition. A germ of a principal analytic set is called *reducible* if there exist $V(f_1)$ and $V(f_2)$ such that $V(f_i) \neq \emptyset$, $V(f_1) \neq V(f_2)$, and

$$V(f) = V(f_1) \cup V(f_2).$$

Lemma. Let $V(f)$ be a germ of a principal analytic set. $V(f)$ is irreducible if and only if there exist an irreducible $g \in \mathbb{C}\langle X_1, \dots, X_n \rangle$ and $k \in \mathbb{N}^*$ such that $f = g^k$.

Theorem. Let $V(f)$ be a germ of a principal analytic set. Then $V(f)$ admits a decomposition

$$V(f) = V(f_1) \cup \dots \cup V(f_r),$$

where the $V(f_\rho)$ are irreducible. This decomposition is unique up to the order in which the components appear.

These are called the *irreducible components*.

The *proofs* are completely analogous to those in Section 1.4, and are recommended to the reader as an exercise.

As in Section 1.6, we call a series $f \in \mathbb{C}\langle X_1, \dots, X_n \rangle$ *minimal* if every prime factor f_ρ of f occurs only once, i.e.

$$f = f_1 \cdot \dots \cdot f_r.$$

If f is minimal, we call

$$\text{ord}(V(f)) := \text{ord } f$$

the *order of the germ*.

If $f \in \mathbb{C}\langle X_1, X_2 \rangle$ is minimal and p is a point on the algebraic curve $C = V(f)$, we can define the *local branches of C at p* : We change coordinates so that $p = 0$, then factor f in $\mathbb{C}\langle X_1, X_2 \rangle$ into prime factors f_1, \dots, f_r and consider the germs of sets

$$V(f_1), \dots, V(f_r).$$

Exercise. Determine the local branches at the origin of the three- and four-leaf clovers of Section 3.3.

Parametrizing the Branches of a Curve by Puiseux Series

7.1. The most important geometric result of the last chapter was that around any point on a curve one can find a decomposition into local branches. In Chapter 8 we will exhibit the relationship between the local branches and the tangents and show how using local analytic methods, rather than the awkward resultant, considerably simplifies the computation of the intersection multiplicity. The algebraic and analytic tools have to be developed quite a bit further before we can do this. We restrict to two variables.

If $f \in \mathbb{C}\langle X, Y \rangle$ is minimal, with $f(0, 0) = 0$, then the branch $V(f)$ is called *smooth* if

$$\text{grad } f := \left(\frac{\partial f}{\partial X}(0), \frac{\partial f}{\partial Y}(0) \right) \neq (0, 0).$$

If $\partial f / \partial Y \neq 0$, the implicit function theorem (Section 6.9) gives us a *local parametrization*

$$x \mapsto \Phi(x) = (x, \varphi(x))$$

of $V(f)$, i.e. a series φ such that $f(x, \varphi(x)) \equiv 0$. If $f = X^3 - Y^2$, for instance, then no such parametrization Φ can exist, as can be seen by a

simple comparison of coefficients. However, there is a parametrization

$$t \mapsto \Phi(t) = (t^2, \varphi(t)), \quad \text{where } \varphi(t) = t^3.$$

Since $x = t^2$ we can formally set $t = x^{\frac{1}{2}}$. This gives a parametrization of the cuspidal cubic

$$x \mapsto \left(x, x^{\frac{3}{2}}\right)$$

with fractional exponents. We will show that locally any branch of a curve has a parametrization of the form

$$t \mapsto (t^n, \varphi(t)) \quad \text{or} \quad x \mapsto \left(x, \varphi\left(x^{\frac{1}{n}}\right)\right),$$

for some power series φ . Such φ are called *Puiseux series*.

The reader interested only in existence can start with Section 7.8. The “geometric” proof given there, however, gives no way to compute the solution φ as a series in the coefficients of f . At least for the lowest-order terms of φ , this was already necessary in Section 5.4. So, in Sections 7.2 to 7.7, we first describe the classical constructive method of Newton and Puiseux. This uses a different kind of geometry, in which the coefficients of a series in two variables correspond to lattice points in the plane.

The applications of Puiseux parametrizations then follow in Chapters 8 and 9.

7.2. Let a formal power series $f(X, Y) \in \mathbb{C}[[X, Y]]$ be given, with $f(0, 0) = 0$. A pair (φ_1, φ_2) of series in $\mathbb{C}[[T]]$ is called a *formal parametrization* of f if $(\varphi_1, \varphi_2) \neq (0, 0)$, $\varphi_1(0) = \varphi_2(0) = 0$, and

$$f(\varphi_1(T), \varphi_2(T)) = 0 \quad \text{in } \mathbb{C}[[T]].$$

Here the substitution of φ_1 and φ_2 into f is to be understood in the sense of Section 6.5. The next theorem states that there is always such a parametrization, with a particularly simple φ_1 .

Theorem on Puiseux series. *Let the series $f \in \mathbb{C}[[X, Y]]$ be general in Y of order $k \geq 1$ (see Section 6.6). Then there exist a natural number $n \geq 1$ and $\varphi \in \mathbb{C}[[T]]$ such that $\varphi(0) = 0$ and*

$$f(T^n, \varphi(T)) = 0 \quad \text{in } \mathbb{C}[[T]].$$

Complement. *If f is convergent, so is φ .*

The proof of the theorem and its complement will take quite a while (Sections 7.3 to 7.11). For the formal part, \mathbb{C} can be replaced by any algebraically closed field. The proof of convergence, however, uses methods of complex analysis and topology.

7.3. We begin with the construction of the formal Puiseux series. Let

$$f = \sum a_{\mu\nu} X^\mu Y^\nu.$$

Our assumption that $a_{00} = 0$ and $a_{01} \neq 0$ in the implicit function theorem made it possible to construct φ by a relatively easy iteration (see Section A.3). In the more general case it is very helpful to sketch the distribution of the nonvanishing coefficients of a series. This method was already used by Newton ([B-K], p. 374). For $f \in \mathbb{C}[[X, Y]]$, we define the *carrier* of f as

$$\text{carr}(f) = \{(\mu, \nu) \in \mathbb{N}^2 : a_{\mu\nu} \neq 0\}.$$

The carrier of a Weierstrass polynomial $f \in \mathbb{C}[[X]][Y]$ is pictured in Figure 7.1.

The carrier of a homogeneous polynomial of degree k lies on a line with slope -1 . To construct the Puiseux series we introduce a generalization of homogeneous polynomials.

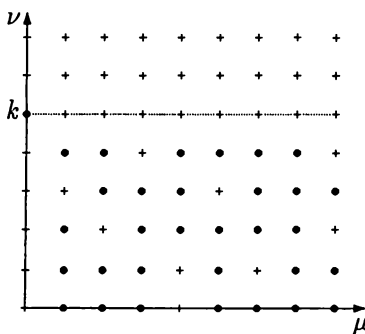

Figure 7.1. Carrier of a Weierstrass polynomial

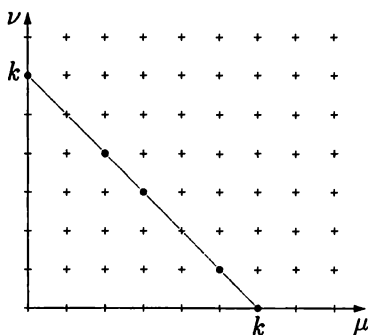

Figure 7.2. Carrier of a homogeneous polynomial

Definition. A polynomial $f \in \mathbb{C}[X, Y]$ is called *quasihomogeneous* if there exist $p, q, l \in \mathbb{N}^*$ such that

$$f = \sum_{q\mu + p\nu = l} a_{\mu\nu} X^\mu Y^\nu.$$

In other words, the carrier of f lies on the line whose equation is $q\mu + p\nu = l$. We call p, q the *weights*. For $p = q = 1$, the polynomial is homogeneous.

If we assume f to be general in Y of order k , then the line must pass through the point $(0, k)$, and it follows that $l = kp$. In particular, $p \neq 0$. In this case the line has equation

$$q\mu + p\nu = kp$$

and slope $-q/p$, and intersects the axis $\nu = 0$ at $s = kp/q$; see Figure 7.3.

Lemma. *If $f \in \mathbb{C}[X, Y]$ is quasihomogeneous with weights p and q , and general in Y of order $k \geq 1$, then there is at least one $\lambda \in \mathbb{C}$ such that*

$$f(T^q, \lambda T^p) = 0.$$

If the carrier of f has at least two points, then we can choose $\lambda \neq 0$.

Thus, taking $n = q$ and $\varphi(T) = \lambda T^p$ gives a solution to the Puiseux problem.

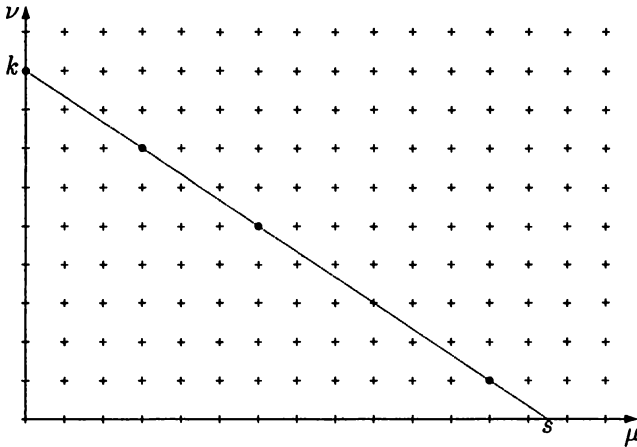

Figure 7.3. Carrier of a quasihomogeneous polynomial

Proof. We start by setting

$$X = T^q, \quad Y = \lambda T^p = \lambda X^{\frac{p}{q}},$$

where purely formal computations will be carried out with the fractional exponents. Then

$$\begin{aligned} f(X, Y) &= f(T^q, \lambda T^p) = \sum_{q\mu + p\nu = kp} a_{\mu\nu} T^{q\mu} \lambda^\nu T^{p\nu} \\ &= T^{kp} \sum_{q\mu + p\nu = kp} a_{\mu\nu} \lambda^\nu =: T^{kp} g(\lambda). \end{aligned}$$

The polynomial $g(\lambda) \in \mathbb{C}[\lambda]$ has degree $k \geq 1$, so it has a zero $\lambda \in \mathbb{C}$. If the carrier of f contains a point (μ, ν) with $\nu < k$, then g has a zero $\lambda \neq 0$. \square

Example. Let $f(X, Y) = Y^4 - 2XY^2 + X^2$. Then $k = 4$, $p = 1$, $q = 2$, and $g(\lambda) = \lambda^4 - 2\lambda^2 + 1$. The zeros are $\lambda = \pm 1$, so

$$X = T^2, \quad Y = \pm T = \pm X^{\frac{1}{2}}.$$

7.4. For a series $f \in \mathbb{C}[[X, Y]]$, we have a homogeneous initial polynomial $f_{(n)}$ of degree $n = \text{ord } f$ (see Section 6.2). For a series that is general in Y of order k we have only $n \leq k$; that is, the initial polynomial $f_{(n)}$ need not be general in Y . Hence, in solving the Puiseux

problem, we must replace the homogeneous initial polynomial $f_{(n)}$ by a *quasihomogeneous initial polynomial* \tilde{f} that is general in Y . According to Newton, we can find it as follows:

Consider the carrier of a series that is general in Y , and place a ruler along the axis $\mu = 0$. Then rotate it around the point $(0, k)$ so that it intersects the axis $\nu = 0$ at a positive μ , and keep rotating until it hits a point in the carrier. The points in the carrier of f that lie on the line thus obtained determine \tilde{f} . Formalized a bit, this gives the definition.

Definition. Let $f = \sum a_{\mu\nu} X^\mu Y^\nu \in \mathbb{C}[[X, Y]]$ be general in Y of order $k \geq 1$. If Y^k is not a divisor of f , then there exist relatively prime $p, q \in \mathbb{N}$, $q \neq 0$, with the following properties:

- $q\mu + p\nu \geq pk$ for all $(\mu, \nu) \in \text{carr}(f)$.
- There exists at least one $(\mu, \nu) \in \text{carr}(f)$ such that $\mu \geq 1$, $\nu < k$, and $q\mu + p\nu = pk$.

We call

$$\tilde{f} := \sum_{q\mu + p\nu = pk} a_{\mu\nu} X^\mu Y^\nu \in \mathbb{C}[X, Y]$$

the *quasihomogeneous initial polynomial* of f . Since $(0, k)$ lies on the line, \tilde{f} is itself general in Y of order k .

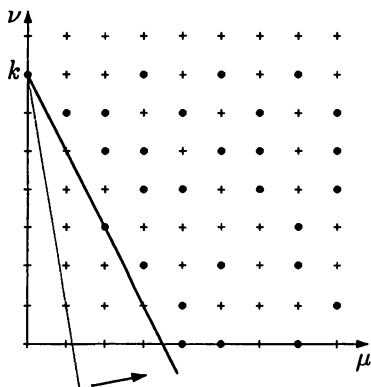

Figure 7.4. Determining the quasihomogeneous initial polynomial

Putting things together, we have a representation

$$f = \tilde{f} + h, \quad \text{where } h = \sum_{q\mu + p\nu \geq pk + 1} a_{\mu\nu} X^\mu Y^\nu \in \mathbb{C}[[X, Y]].$$

The series h contains the “higher-order” terms. The line used in the definition of \tilde{f} is the steepest segment of the so-called *Newton polygon*, which can be used to study the factorization of f (see Appendix 4).

7.5. The quasihomogeneous initial polynomial of Section 7.4 and the solution of the Puiseux problem for a quasihomogeneous polynomial given in Section 7.3 provide the basis for an iteration. Suppose that Y^k is not a divisor of f , and let

$$f = \tilde{f} + h.$$

Setting $\tilde{Y} = \lambda X^{\frac{p}{q}}$ and $s = pk/q$, we have

$$\tilde{f}(X, \tilde{Y}) = X^s \sum_{q\mu + p\nu = pk} a_{\mu\nu} \lambda^\nu = X^s g(\lambda) = 0$$

by Section 7.3. A λ satisfying $g(\lambda) = 0$ gives a \tilde{Y} that solves the Puiseux problem for \tilde{f} ; we may take \tilde{Y} as an approximate solution for f . To do this, we start with

$$X = X_1^q, \quad Y = \tilde{Y} + X_1^p Y_1 = X_1^p (\lambda + Y_1),$$

then substitute this into f to get a condition on X_1 and Y_1 :

$$\begin{aligned} f(X, Y) &= \tilde{f}(X, Y) + h(X, Y) = X_1^{pk} (g(\lambda + Y_1) + X_1 h^*(X_1, Y_1)) \\ &= X_1^{pk} f_1(X_1, Y_1). \end{aligned}$$

In particular,

$$f_1(0, Y_1) = g(\lambda + Y_1).$$

The following lemma is crucial for the formal convergence of the iteration in Section 7.6.

Lemma. *Let f and f_1 be as above.*

- a) f_1 is general in Y_1 of order k_1 , where $1 \leq k_1 \leq k$.
- b) If $k_1 = k$, then $q = 1$.

Proof. a) Let $\gamma(Y_1) := g(\lambda_0 + Y_1) \in \mathbb{C}[Y_1]$, where $\lambda_0 \in \mathbb{C}^*$ and $g(\lambda_0) = 0$. Then

$$k_1 = \text{ord } \gamma = \text{multiplicity of the zero } \lambda_0 \text{ of } g \leq \deg g = k.$$

b) If $k_1 = k$, then by (a) there exists $c \in \mathbb{C}^*$ such that

$$g(\lambda) = c(\lambda - \lambda_0)^k = \sum_{q\mu + p\nu = kp} a_{\mu\nu} \lambda^\nu = a_{0k} \lambda^k + a_{\mu, k-1} \lambda^{k-1} + \dots$$

By the binomial formula, there exists $\mu > 0$ such that

$$a_{\mu, k-1} = -ck\lambda_0 \neq 0 \quad \text{and} \quad q\mu + p(k-1) = pk,$$

so the carrier of \tilde{f} has a point on the line $\nu = k - 1$.

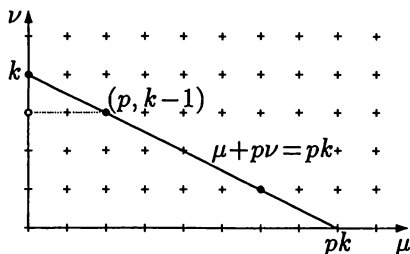

Figure 7.5. Carrier of \tilde{f}

Now, q is a divisor of p since $q\mu = p$, and $q = 1$ since p and q were assumed to be relatively prime. \square

7.6. Now the technical tools are available to set up an iteration process for the solution of the Puiseux problem. To begin with, all we can do is ensure that the procedure converges formally (see Section 6.2).

We are given $f(X, Y)$, general in Y of order k . What we want is $Y = \varphi(X^{\frac{1}{n}})$. We start with

$$f_0 = f, \quad X_0 = X, \quad Y_0 = Y, \quad k_0 = k.$$

To get from i to $i + 1$ we do the following: If $Y_i^{k_i}$ is a divisor of f_i , then $Y_i = 0$ is a solution of $f_i(X_i, Y_i) = 0$. Otherwise, by Section 7.4, f_i has a decomposition

$$f_i = \tilde{f}_i + h_i,$$

where \tilde{f}_i is quasihomogeneous and the equation of the carrier of \tilde{f}_i is

$$q_i \mu + p_i \nu = k_i p_i.$$

Since the carrier of \tilde{f}_i has at least two points, by Section 7.3 there exist $\lambda_i \in \mathbb{C}^*$ and a solution

$$\tilde{Y}_i = \lambda_i X_i^{\frac{p_i}{q_i}} \quad \text{of} \quad \tilde{f}_i(X_i, \tilde{Y}_i) = 0.$$

Setting

$$X_i = X_{i+1}^{q_i}, \quad Y_i = \tilde{Y}_i + X_{i+1}^{p_i} Y_{i+1} = X_i^{p_i} (\lambda_i + Y_{i+1})$$

gives

$$f_i(X_i, Y_i) = X_{i+1}^{p_i k_i} f_{i+1}(X_{i+1}, Y_{i+1}),$$

and f_{i+1} is general in Y_{i+1} of order k_{i+1} . By part (a) of the lemma in Section 7.5,

$$k = k_0 \geq k_1 \geq \cdots \geq k_i \geq k_{i+1} \geq \cdots \geq 1.$$

By part (b) there is an $N \in \mathbb{N}$ such that $q_j = 1$ for $j > N$. Hence

$$X = X_0 = X_1^{q_0} = X_2^{q_0 q_1} = \cdots = X_N^{q_0 \cdots q_N} = X_j^n$$

for $n = q_0 \cdots q_N$ and $j > N$. Fractional exponents can be avoided by setting

$$X = T^n \quad \text{and} \quad X_i = T^{q_i \cdots q_N} \quad \text{for} \quad 0 \leq i \leq N.$$

This shows that the denominators in the exponent of X (or the powers of T) cannot grow without bound.

Now we turn to Y . By construction,

$$\begin{aligned} Y &= Y_0 = \tilde{Y}_0 + X_1^{p_0} Y_1 = \tilde{Y}_0 + X_1^{p_0} \cdot (\tilde{Y}_1 + X_2^{p_1} Y_2) = \cdots \\ &= \tilde{Y}_0 + \sum_{i=1}^{\infty} X_1^{p_0} \cdots X_i^{p_{i-1}} \cdot \tilde{Y}_i \\ &= \lambda_0 X_0^{\frac{p_0}{q_0}} + \sum_{i=1}^{\infty} \lambda_i X_1^{p_0} \cdots X_i^{p_{i-1} + \frac{p_i}{q_i}} \\ &= \sum_{i=0}^{\infty} \lambda_i T^{m_i}, \end{aligned}$$

where

$$m_0 = p_0 q_1 \cdots q_N \quad \text{and} \quad m_{i+1} = m_i + p_{i+1} \prod_{j>i+1} q_j.$$

Since $p_i \geq 1$, we have shown that under the iteration, the powers of $T = X^{\frac{1}{n}}$ increase at each step. In other words, the construction of Y converges formally. Although not all powers of T have to appear, the series above can be written in the form

$$Y = \varphi(T) = \sum_{j=1}^{\infty} c_j T^j = \sum_{j=1}^{\infty} c_j X^{\frac{j}{n}} = \varphi(X^{\frac{1}{n}}),$$

where $c_j \in \mathbb{C}$.

It remains to show that this *Puiseux series* solves the given problem, i.e. that

$$f(T^n, \varphi(T)) = 0 \quad \text{in } \mathbb{C}[[T]].$$

To do this, we show that $f(T^n, \varphi(T))$ is in $m^r \subset \mathbb{C}[[T]]$ for every r (see Remark 1 in Section 6.2). By construction, f_i is divisible by $X_{i+1}^{p_i k_i}$. Hence $f = f_0$ is divisible by

$$X_1^{p_0 k_0} \cdot X_2^{p_1 k_1} \cdot \dots \cdot X_{i+1}^{p_i k_i} = T^r,$$

where

$$r = k_0 p_0 q_1 \cdot \dots \cdot q_N + k_1 p_1 q_2 \cdot \dots \cdot q_N + \dots + k_{N-1} p_{N-1} q_N + \sum_{j=N}^i k_j p_j.$$

But $k_j, p_j \geq 1$, so $r_i > i$ and hence is arbitrarily large. This proves the formal part of the theorem on the Puiseux series.

In the construction of φ , the choice of a root $\lambda_i \in \mathbb{C}^*$ comes up at every step. We will not see until later that, even so, only finitely many distinct series can arise.

Example. For

$$f = Y^4 - 2Y^2X - 4Y^2X^2 - 3Y^2X^3 + X^2 + 4X^3 + 7X^4 + 6X^5 + 2X^6,$$

we have

$$\tilde{f} = Y^4 - 2Y^2X + X^2, \quad \lambda_0 = -1, \quad X = X_1^2, \quad Y = X_1(Y_1 - 1),$$

$$f_1 = Y_1^4 - 4Y_1^3 + 4Y_1^2 - 4X_1^2Y_1^2 + 8X_1^2Y_1 - 3X_1^4Y_1^2 \\ + 6X_1^4Y_1 + 4X_1^4 + 6X_1^6 + 2X_1^8,$$

$$\tilde{f}_1 = 4Y_1^2 + 8X_1^2Y_1 + 4X_1^4, \quad \lambda_1 = -1.$$

It follows from $f_1(X_1, Y_1) = 0$ that $f(T^2, -T - T^3) = 0$. The process terminates after the second iteration. Of course, this happens only for very special f .

7.7. Using the Puiseux series leads to a parametrization of the special form

$$T \mapsto (T^n, \varphi(T)).$$

We will show that any arbitrary parametrization can be brought into this form through a transformation of the parameter T .

We obtain a corollary of the theorem on the Puiseux series.

Corollary. *Let (ψ_1, ψ_2) be a formal parametrization of g in the sense of Section 7.2, with $\text{ord } \psi_1 = k < \infty$. Then there exists a series $\beta \in \mathbb{C}[[T]]$ such that $\text{ord } \beta = 1$ and*

$$\psi_1(\beta(T)) = T^k.$$

Thus a new formal parametrization of g is given by

$$(T^k, \psi_2(\beta(T))).$$

For $\varphi(T) := \psi_2(\beta(T))$, we have $\text{ord } \varphi = \text{ord } \psi_2$.

Remark. The (as yet unproved) complement on the convergence of the Puiseux series can be used to prove an analogous version of the corollary for convergent parametrizations. This corresponds to the usual change of parameters $S = \beta(T)$.

Proof of the corollary. Let

$$\psi_1(t) = \sum_{j=k}^{\infty} a_j T^j, \quad \text{where } a_k \neq 0.$$

Then the series

$$f(X, Y) := X - \psi_1(Y)$$

is general in Y of order k . By the theorem, there exist n and $\beta \in \mathbb{C}[[T]]$ such that

$$0 = f(T^n, \beta(T)) = T^n - \psi_1(\beta(T)).$$

To see that $n = k$, we have to examine the passage from $f = f_0$ to f_1 in Section 7.5. With the notation used there and the special f defined here, we have

$$\tilde{f} = X - a_k Y^k, \quad p = 1, \quad q = k; \quad \text{hence} \quad \tilde{Y} = \lambda X^{\frac{1}{k}}.$$

Thus

$$\gamma(Y_1) = g(\lambda + Y_1) = 1 - a_k(\lambda + Y_1)^k = -ka_k\lambda^{k-1}Y_1 + \dots.$$

It follows that $k_1 = 1$. Hence $q_i = 1$ for $i \geq 1$, and $n = k$. Since $p = 1$ and $\lambda \neq 0$, we finally obtain $\text{ord } \beta = 1$. \square

7.8. Now we turn to the problem of convergence of the Puiseux series (formulated as a *complement* in Section 7.2). In the special case of the implicit function theorem, the convergence of φ can still be derived relatively easily from the convergence of f (see Appendix 3). For the Puiseux series, this is more complicated (see [Che], 8.6, for example).

We choose a completely different approach here (see [B-K]). Using methods from complex analysis and topology, we prove just the existence of sufficiently many convergent solutions. Afterwards we use an algebraic trick to show that the formally constructed series is equal to one of the convergent solutions, so must itself be convergent.

Before formulating the geometric version of Puiseux's theorem, we recall a special case of the resultant: the *discriminant* D_f of a polynomial $f \in A[Y]$ for a ring A .

Remark. Let $U \subset \mathbb{C}$ be a domain, and let $A := \mathcal{O}(U)$ be the ring of holomorphic functions in U . For $f \in A[Y]$, with $a_0 = 1$ and $x \in U$, let

$$f_x := Y^k + a_1(x)Y^{k-1} + \dots + a_k(x) \in \mathbb{C}[Y].$$

Then f_x has a multiple zero in \mathbb{C} if and only if $D_f(x) = 0$.

Proof. $D_f(x) = D_{f_x}$, and the assertion follows from Corollary 2 in Appendix 1.2. \square

Puiseux's theorem (geometric version). Let

$$f(X, Y) = Y^k + a_1(X)Y^{k-1} + \dots + a_k(X) \in \mathbb{C}\langle X \rangle[Y], \quad k \geq 1,$$

be an irreducible Weierstrass polynomial. Let $\varrho > 0$ be chosen such that

- a) a_1, \dots, a_k converge in $U := \{x \in \mathbb{C} : |x| < \varrho\}$,
- b) $D_f(x) \neq 0$ in $U^* := U \setminus \{0\}$.

Furthermore, let

$$V := \{t \in \mathbb{C} : |t| < \varrho^{\frac{1}{k}}\},$$

$$C := \{(x, y) \in U \times \mathbb{C} : f(x, y) = 0\}.$$

Then there exists a series $\varphi \in \mathbb{C}\langle T \rangle$ that converges in V and has the following properties:

- i) $f(t^k, \varphi(t)) = 0$ for all $t \in V$;
- ii) $\Phi : V \rightarrow C, t \mapsto (t^k, \varphi(t))$, is bijective.

The situation for $k = 3$ and $\varrho = 1$ is illustrated in the following sketch, where only the real component of the Y -direction is drawn,

$$p_k : V \rightarrow U \quad \text{is given by } t \mapsto t^k,$$

$$\pi : U \times \mathbb{C} \rightarrow U, \quad (x, y) \mapsto x, \quad \text{is projection.}$$

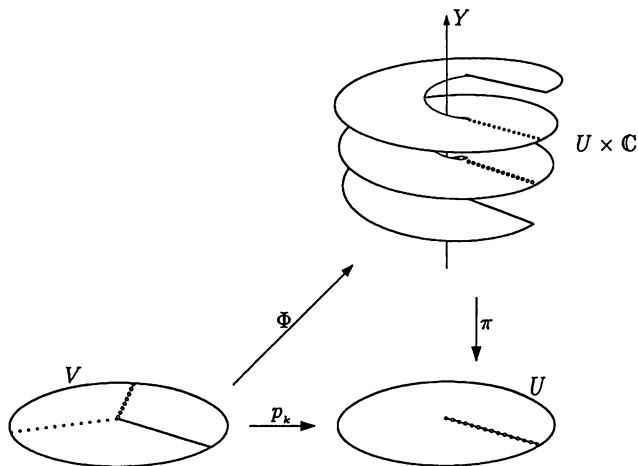

Figure 7.6. Puiseux's theorem (geometric version)

7.9. This geometric form of Puiseux's theorem is due to Picard. The proof reproduced here from [Fol] uses techniques from the theory of holomorphic functions. The topological techniques from covering space theory are collected in Appendix 2. The notation and hypotheses in the lemmas are as in the theorem above.

First, note that condition (b) is satisfied for sufficiently small ϱ : Corollary 1 of Appendix 1.2 implies that since f is irreducible, $D_f \neq 0$ in $\mathbb{C}\langle X \rangle$; thus 0 is an isolated zero of the function D_f .

Lemma 1. *Let $C^* = C \setminus \{(0, 0)\} \subset U^* \times \mathbb{C}$. Then the projection*

$$\pi^* = \pi|_{C^*} : C^* \rightarrow U^*$$

is a covering map.

Proof. It must be shown that for every $x \in U^*$ there is a disk W around x in U^* such that, for every connected component \widetilde{W} of $\pi^{*-1}(W) \subset C^*$,

$$\pi|_{\widetilde{W}} : \widetilde{W} \rightarrow W$$

is a homeomorphism. Since $D_f(x) \neq 0$, we have

$$f_x = f(x, Y) = (Y - c_1) \cdots (Y - c_k),$$

with distinct $c_1, \dots, c_k \in \mathbb{C}$. Now we change coordinates to get $x = 0$. By Hensel's lemma (Section 6.10), there exist $f_1, \dots, f_k \in \mathbb{C}\langle X \rangle[Y]$ such that $\deg f_i = 1$ and $f = f_1 \cdots f_k$. Since the f_i are linear, there exist $\psi_1, \dots, \psi_k \in \mathbb{C}\langle X \rangle$ such that

$$f_i = Y - \psi_i, \quad \text{so} \quad f(X, Y) = (Y - \psi_1(X)) \cdots (Y - \psi_k(X))$$

in $\mathbb{C}\langle X \rangle[Y]$. We can choose a disk W around x so small that the series ψ_1, \dots, ψ_k converge in W and the images \widetilde{W}_i of the maps

$$W \rightarrow \widetilde{W}_i \subset U^* \times \mathbb{C}, \quad x \mapsto (x, \psi_i(x)),$$

are disjoint. Then the projections

$$\pi|_{\widetilde{W}_i} : \widetilde{W}_i \rightarrow W$$

are homeomorphisms for $i = 1, \dots, k$. □

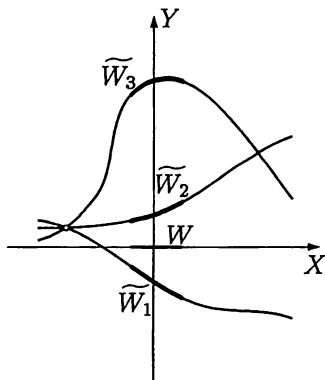

Figure 7.7

Lemma 2. C^* is connected.

Proof. Suppose there is a connected component D of C^* such that

$$\emptyset \neq D \neq C^*.$$

Then

$$\eta := \pi|_D : D \rightarrow U^*$$

is itself an l -fold covering, where $1 \leq l \leq k$ (see Remark 2 of Appendix 2.1). If the disk W around x is chosen as in the proof of Lemma 1, the connected components \widetilde{W}_i of $\pi^{-1}(W)$ can be numbered so that

$$\eta^{-1}(W) = \widetilde{W}_1 \cup \cdots \cup \widetilde{W}_l.$$

We define

$$g(x, y) := \begin{cases} Y^l & \text{for } x = 0, \\ \prod_{(x,c) \in D} (Y - c) & \text{for } x \in U^*. \end{cases}$$

Now we use the functions ψ_i of Lemma 1, which are holomorphic in W . For $x \in W$, it follows that

$$g(x, Y) = \prod_{i=1}^l (Y - \psi_i(x)) = Y^l + a_1(x)Y^{l-1} + \cdots + a_l(x),$$

where the a_i are the elementary symmetric functions in ψ_1, \dots, ψ_l . Hence the coefficients a_i of g are holomorphic in U^* . By the continuity

of the roots (Section 6.8), the extension defined by setting $a_i(0) = 0$ is continuous. Hence

$$g(x, Y) \in \mathcal{O}(U)[Y], \quad 1 \leq \deg g \leq l < k$$

by Riemann's removable singularities theorem, and g is a divisor of f in $\mathbb{C}(X)[Y]$ by construction. This contradicts the irreducibility of f . \square

Lemma 3. *Let $V^* := V \setminus \{0\}$. Then there exists a homeomorphism $\Phi^* : V^* \rightarrow C^*$ such that the diagram*

$$\begin{array}{ccc} V^* & \xrightarrow{\Phi^*} & C^* \\ p_k^* \searrow & & \swarrow \pi^* \\ & U^* & \end{array}$$

commutes. Here $p_k^ = p_k|_{V^*}$.*

Proof. The maps p_k^* and π^* are both k -fold coverings of U^* , with a connected total space. By the classification of such coverings in topology (see Remark 1 in Section A.2.1), they differ only by a homeomorphism Φ^* as indicated. The origin is a *branch point* of order k (see Section 9.6). \square

Lemma 4. *The continuous map*

$$\Phi^* : V^* \rightarrow C^* \subset \mathbb{C}$$

whose existence is given by Lemma 3 is holomorphic, and setting $\Phi(0) := (0, 0)$ gives a holomorphic extension

$$\Phi : V \rightarrow \mathbb{C}, \quad t \mapsto (t^k, \varphi(t)).$$

Proof. The map Φ^* of Lemma 3 has the form

$$\Phi^*(t) = (t^k, \varphi^*(t)), \quad \text{where } \varphi^* : V^* \rightarrow \mathbb{C} \text{ is continuous.}$$

Hence it suffices to show that φ^* is holomorphic at every point $s \in V^*$. If $x = s^k$, then $\varphi^*(s)$ must be one of the k roots $c_1, \dots, c_k \in \mathbb{C}$ of f_x ; thus $\varphi^*(s) = c_i$. We choose a disk W around x as in the proof of

Lemma 1, and let \widetilde{W}_i be the connected component containing (x, c_i) . Setting $\widetilde{V} := \Phi^{*-1}(\widetilde{W}_i)$ gives

$$\Phi^*(t) = (t^k, \varphi^*(t)) = (t^k, \psi_i(t^k)) \quad \text{for } t \in \widetilde{V}.$$

Hence $\varphi^*(t) = \psi_i(t^k)$. Since ψ_i is holomorphic by the proof of Lemma 1, φ^* is holomorphic in \widetilde{V} . If we extend φ by setting $\varphi(0) := 0$, then by the continuity of the roots of f we obtain a continuous extension

$$\varphi : V \rightarrow \mathbb{C} \quad \text{of} \quad \varphi^* : V^* \rightarrow \mathbb{C}.$$

By the removable singularities theorem, φ is holomorphic. Thus Φ is holomorphic. \square

This completes the proof of the theorem of Section 7.8.

7.10. In the proof that the Puiseux series converges, knowing all possible solutions of the Puiseux problem is crucial. We use the notation and hypotheses of the theorem of Section 7.8 to prove another result.

Complement. Let $\Phi(t) = (t^k, \varphi(t))$ be a convergent solution and let $\zeta = \exp(2\pi i/k) \in \mathbb{C}$ be a primitive k th root of unity. For $\nu = 1, \dots, k$, let

$$\varphi_\nu(t) := \varphi(\zeta^\nu t) \quad \text{and} \quad \Phi_\nu(t) := (t^k, \varphi_\nu(t)).$$

Then Φ_1, \dots, Φ_k are distinct parametrizations of C ; that is, the series $\varphi_1, \dots, \varphi_k$ are distinct.

Proof. Note that the roots of unity act on elements of the domain of φ , not on elements of the range. Hence this statement can also be proved purely algebraically for formal series (see [Wa]). In the convergent case, however, the proof is much simpler: The maps

$$V \rightarrow V, \quad t \mapsto \zeta^\nu t,$$

are bijective, and for $\nu = 1, \dots, k$ they are distinct. Hence the bijective maps

$$\Phi_\nu : V \rightarrow C$$

are distinct. \square

From a geometric point of view, the maps Φ_ν differ from each other by permutations of the sheets of the covering $C^* \rightarrow U^*$. Thus

the roots of unity act as *covering transformations* (or *deck transformations*).

The parametrizations $\varphi_1, \dots, \varphi_k$ can now be used to extend the factorization

$$f_x(Y) = (Y - c_1) \cdot \dots \cdot (Y - c_k), \quad \text{where } c_i \in \mathbb{C},$$

which exists for every $x \in U^*$, to all of U .

Corollary. *Let $f \in \mathbb{C}\langle X \rangle[Y]$ be an irreducible Weierstrass polynomial of degree $k \geq 1$,*

$$T \mapsto (T^k, \varphi(T))$$

a parametrization as in Theorem 7.8, and $\varphi_\nu(T) := \varphi(\zeta^\nu T)$, where $\zeta := \exp(2\pi i/k)$. Then

$$f(T^k, Y) = (Y - \varphi_1(T)) \cdot \dots \cdot (Y - \varphi_k(T)) \quad \text{in } \mathbb{C}\langle T \rangle[Y].$$

Proof. Consider the polynomial $f(T^k, Y) \in \mathbb{C}\langle T \rangle[Y]$. It has distinct zeros $\varphi_1, \dots, \varphi_k$ in the integral domain $\mathbb{C}\langle T \rangle$. Since f is normalized, we can use the zeros to split off linear factors one by one. This gives the desired factorization. Note that we need not pass to the quotient field of $\mathbb{C}\langle T \rangle$ for this division. \square

7.11. Now we can prove the complement on the *convergence of the Puiseux series* that was stated in Section 7.2. Let $f \in \mathbb{C}\langle X, Y \rangle$ be the given series general in Y , and let $\varphi \in \mathbb{C}\llbracket S \rrbracket$ be a solution obtained through the formal construction; that is, $f(S^n, \varphi(S)) = 0$. By the preparation theorem,

$$f = \alpha \cdot p_1 \cdot \dots \cdot p_r,$$

where α is a unit and p_1, \dots, p_r are irreducible Weierstrass polynomials. Now,

$$\alpha(S^n, \varphi(S)) \neq 0 \quad \text{implies that} \quad p_j(S^n, \varphi(S)) = 0$$

for some j . Hence we may assume without loss of generality that $f \in \mathbb{C}\langle X \rangle[Y]$ was an irreducible Weierstrass polynomial of degree k , and φ a formal solution of f .

To be able to compare φ with the factorization of f in Corollary 7.10, we have to match up the two parametrizations

$$X = T^k = S^n.$$

In the formal construction, there is no problem in just increasing the denominator n , so we may assume that

$$n = k \cdot l \quad \text{and hence that } X = T^k = S^{k \cdot l}, \quad \text{so } T = S^l.$$

Thus

$$f(S^n, Y) = \prod_{\nu=1}^k (Y - \varphi_\nu(S^l)) \in \mathbb{C}[[S]][Y].$$

Since φ is also a zero of $f(S^n, Y) \in \mathbb{C}[[S]][Y]$ in the integral domain $\mathbb{C}[[S]]$, we must have $\varphi(S) = \varphi_\nu(S^l)$ for some ν . Hence φ itself is convergent. \square

The geometric form of Puiseux's theorem has some important consequences.

In the theorem on the Puiseux series (Section 7.2), nothing could be said about the number n compared to k . The proof above implies the following result.

Corollary 1. *If the irreducible series $f \in \mathbb{C}\langle X, Y \rangle$ is general in Y of order k , then there exists a series $\varphi \in \mathbb{C}\langle T \rangle$ such that*

$$f(T^k, \varphi(T)) = 0 \quad \text{in } \mathbb{C}\langle T \rangle.$$

In the implicit function theorem (Section 6.9), we could prove only that $f(X, \varphi(X)) = 0$, but not that φ fills out a neighborhood of the origin in the zero set of f . By Section 7.9 this is clear, at least for $n = 1$:

Corollary 2. *If $f \in \mathbb{C}\langle X, Y \rangle$, with $f(0, 0) = 0$ and $(\partial f / \partial Y)(0) \neq 0$, then there is exactly one series $\varphi \in \mathbb{C}\langle X \rangle$ such that*

$$f(x, y) = 0 \iff y = \varphi(x)$$

for sufficiently small x and y .

Corollary 3. *If $f \in \mathbb{C}\langle X, Y \rangle$ is irreducible, then f is also irreducible in $\mathbb{C}[[X, Y]]$.*

Proof. We may assume that $f \in \mathbb{C}\langle X \rangle[Y]$ is a Weierstrass polynomial of degree k . By Section 7.10,

$$f(T^k, Y) = (Y - \varphi_1(T)) \cdot \dots \cdot (Y - \varphi_k(T)) \quad \text{in } \mathbb{C}\llbracket T \rrbracket[Y].$$

Since $\varphi_1, \dots, \varphi_k$ are convergent and $\mathbb{C}\llbracket X, Y \rrbracket$ is a unique factorization domain (Exercise 2 of Section 6.11), all possible formal factors of f are convergent. \square

This observation shows that there is no change in the divisibility theory in passing from convergent to formal power series—in contrast to the passage from polynomials to convergent power series (see Section 6.1). Hence one can also do curve theory over more general fields, by using formal power series for the local part. If arguments using the values of the series no longer work, the proofs (by analogy with Complement 7.10, for instance) become more complicated but lead to interesting additional insights. For more on this, we refer the reader to the classic [Wa] or to [Che].

7.12. Since $\mathbb{C}\llbracket X, Y \rrbracket = \mathbb{C}\llbracket X \rrbracket\llbracket Y \rrbracket$, when we deal with polynomials of several variables we can distinguish one of them and determine the resultant with respect to it. The resultant is then a polynomial in the other variables. As we saw in Section 7.11, a polynomial can be split into linear factors by extending the ring of coefficients $\mathbb{C}\llbracket X \rrbracket$. For a later application to resultants, we have to push this a bit further.

To be able to compute with Puiseux series that have arbitrary denominators in the exponent, we will find it useful to extend the ring $\mathbb{C}\llbracket X \rrbracket$ of formal power series as follows: For every $n \geq 1$, there is an injective homomorphism

$$\mathbb{C}\llbracket X \rrbracket \rightarrow \mathbb{C}\llbracket T \rrbracket, \quad X \mapsto T^n.$$

We regard this as a ring extension

$$\mathbb{C}\llbracket X \rrbracket \subset \mathbb{C}\llbracket T \rrbracket = \mathbb{C}\llbracket X^{\frac{1}{n}} \rrbracket, \quad \text{where } X^{\frac{1}{n}} = T, \text{ i.e. } X = T^n.$$

If $m = k \cdot n$, there are injections

$$\mathbb{C}\llbracket X \rrbracket \rightarrow \mathbb{C}\llbracket T \rrbracket \rightarrow \mathbb{C}\llbracket S \rrbracket,$$

$$X \mapsto T^n, \quad T \mapsto S^k,$$

$$X \mapsto (S^k)^n = S^m,$$

which can again be regarded as inclusions

$$\mathbb{C}[X] \subset \mathbb{C}[X^{\frac{1}{n}}] \subset \mathbb{C}[X^{\frac{1}{m}}].$$

Continuing in this way, we form

$$\mathbb{C}[X^*] := \bigcup_{n=1}^{\infty} \mathbb{C}[X^{\frac{1}{n}}].$$

This is an integral domain that contains all formal Puiseux series. For a fixed $\varphi \in \mathbb{C}[X^*]$, there is an $n \in \mathbb{N}$ such that $\varphi \in \mathbb{C}[X^{\frac{1}{n}}]$. Hence

$$\varphi = \sum_{m=0}^{\infty} a_m X^{\frac{m}{n}}, \quad \text{where } a_m \in \mathbb{C},$$

and we can define the rational number

$$\text{ord } \varphi : \min \left\{ \frac{m}{n} : a_m \neq 0 \right\} \geq 0$$

to be the *order of* φ . For brevity, we often write

$$\varphi = cX^{\rho} + \cdots, \quad \text{where } c \in \mathbb{C}^* \text{ and } \rho = \text{ord } \varphi \in \mathbb{Q}_+.$$

The importance of the ring $\mathbb{C}[X^*]$ can be seen in the following lemma.

Lemma. *Every normalized polynomial in $\mathbb{C}\langle X \rangle[Y]$ splits into linear factors in the ring extension $\mathbb{C}[X^*]$.*

This is the crucial step on the path to the following theorem.

Theorem. *The quotient field of $\mathbb{C}[X^*]$ is algebraically closed.*

Here it is important that the ground field \mathbb{C} is algebraically closed and that X is just a single indeterminate. The proof of the theorem from the lemma is left to the reader as a demanding exercise (see [Wa]). Later on we will apply the lemma to $\mathbb{C}[X][Y]$, to reveal the secret of the resultant in Appendix 1. We also recommend that, for practice, the reader prove the lemma in this special case without using Hensel's lemma.

Proof of the lemma. Let $f \in \mathbb{C}\langle X \rangle[Y]$ be normalized, $\deg f = k$, and

$$\bar{f}(Y) := f(0, Y) = (Y - c_1)^{k_1} \cdots (Y - c_r)^{k_r},$$

where c_1, \dots, c_r are distinct. By Hensel's lemma there exist normalized $f_1, \dots, f_r \in \mathbb{C}\langle X \rangle[Y]$ such that $\bar{f}_i = (Y - c_i)^{k_i}$. If some $c_i = 0$, then the preparation theorem can be applied to f_i , so

$$f_i = \alpha_i \cdot p_i,$$

where p_i is a Weierstrass polynomial of degree k_i . If q is an irreducible factor of p_i of degree l , then by Section 6.11 q is itself a Weierstrass polynomial, and by Section 7.10

$$q = (Y - \psi_1) \cdot \dots \cdot (Y - \psi_l), \quad \text{where } \psi_j \in \mathbb{C}[[X^*]].$$

It follows that

$$p_i = (Y - \varphi_{i,1}) \cdot \dots \cdot (Y - \varphi_{i,k_i}), \quad \text{where } \varphi_{i,j} \in \mathbb{C}[[X^*]]. \quad (*)$$

Here $\text{ord } \varphi_{i,j} > 0$. If $c_i \neq 0$ for all i , we apply the change of variables $\tilde{Y} = Y + c_i$ and set $\tilde{f}_i(Y) = f_i(\tilde{Y})$. This gives a factorization similar to (*), but in this case

$$\varphi_{i,j} = c_i + \dots, \quad \text{so } \text{ord } \varphi_{i,j} = 0.$$

Putting things together, let

$$p := p_1 \cdot \dots \cdot p_r = \prod_{i,j} (Y - \varphi_{i,j}).$$

Since f and p have the same zeros (counted with multiplicities) in $\mathbb{C}[[X^*]]$ and are both normalized, we conclude that $f = p$. \square

Another result, which will be used in Appendix 4, follows from this proof and the corollary in Section 7.10.

Complement. *If $f \in \mathbb{C}\langle X \rangle[Y]$ is a Weierstrass polynomial of degree k , there is a factorization*

$$f = (Y - \varphi_1) \cdot \dots \cdot (Y - \varphi_k),$$

where $\varphi_i \in \mathbb{C}[[X^*]]$ and $\text{ord } \varphi_i > 0$ for $i = 1, \dots, k$. If f is irreducible, then all the φ_i have the same order.

Tangents and Intersection Multiplicities of Germs of Curves

8.1. In Section 3.4 we defined tangents at a point on a plane algebraic curve in terms of zeros of the initial polynomial. If the point is smooth, then the initial polynomial is linear and there is exactly one tangent. At a singular point the number of tangents, counted with multiplicities, is given by the order of the curve. With the techniques now available we can understand the geometric properties of these tangents. In particular, we can prove Theorem 3.6, which we have already used several times. An analogue of this theorem is valid for germs of curves.

Definition. Let $f \in \mathbb{C}\langle X, Y \rangle$, where $l = \text{ord } f \geq 1$ and $f_{(l)}$ is the initial polynomial of f . Then the lines in $V(f_{(l)}) \subset \mathbb{C}^2$ are called *tangents to the germ* $C = V(f)$.

If

$$f = f_1^{s_1} \cdot \dots \cdot f_m^{s_m}$$

is a factorization into irreducible elements, then the initial polynomial factors as

$$f_{(l)} = f_{1, (l_1)}^{s_1} \cdot \dots \cdot f_{m, (l_m)}^{s_m}.$$

Thus the tangents to C are the union of the tangents to the components $C_j = V(f_j)$. For a given f , we can choose coordinates so that X is not a divisor of f . Then X is not a divisor of any f_j , so we can assume that

$$f_j \in \mathbb{C}\langle X \rangle[Y]$$

is a Weierstrass polynomial of degree $k_j \geq 1$. The following result is now crucial.

Theorem. *Let $f \in \mathbb{C}\langle X \rangle[Y]$ be an irreducible Weierstrass polynomial of degree k , and let $l := \text{ord } f$. Then there exist $a, b \in \mathbb{C}$ such that $(a, b) \neq (0, 0)$ and*

$$f_{(l)} = (aX + bY)^l.$$

Geometrically, this means that an irreducible germ $V(f)$ has a unique tangent of multiplicity l . Of course, several branches can have the same tangent (Figure 3.4), and $f_{(l)}$ can be a power of a linear form without f being irreducible ($f = f_{(l)}$, for instance)!

Proof. We use the Puiseux parametrization

$$T \mapsto (T^k, \varphi(T)), \quad \text{where } \varphi(T) = cT^r + \dots, \quad c \neq 0, \quad r \geq 1.$$

By Corollary 7.10, we have

$$f(X, Y) = \left(Y - \varphi_1(X^{\frac{1}{k}})\right) \cdots \left(Y - \varphi_k(X^{\frac{1}{k}})\right), \quad \text{where} \\ \varphi_\nu(X^{\frac{1}{k}}) = \varphi(\zeta^\nu X^{\frac{1}{k}}) = c\zeta^{\nu r} X^{\frac{r}{k}} + \dots,$$

with $\zeta = \exp(2\pi i/k)$. Set

$$\tilde{f}(X, Y) := \prod_{\nu=1}^k (Y - c\zeta^{\nu r} X^{\frac{r}{k}}).$$

Clearly $f_{(l)} = \tilde{f}_{(l)}$. Hence

$$f_{(l)} = \begin{cases} aX^r, & \text{with } a \in \mathbb{C}^*, & \text{so } l = r, & \text{if } r < k, \\ (Y - cX)^r, & & \text{so } l = k, & \text{if } r = k, \\ Y^k, & & \text{so } l = k, & \text{if } r > k. \end{cases} \quad \square$$

In the third case the tangent is horizontal. In this case the pair of critical exponents (k, r) , where $1 \leq k < r$, in the Puiseux parametrization is called the *Puiseux pair* of f . We will see in Section 8.3 that it can be described by intersection multiplicities. The Puiseux pair is related to the local invariants of Section 5.4 by

$$k = 1 + \alpha_1, \quad r = 2 + \alpha_1 + \alpha_2.$$

Exercise. For $f = X^r - Y^k$, with $k \geq 1$ and $r \geq 2$, the following conditions are equivalent:

- a) f is irreducible in $\mathbb{C}[X, Y]$.
- b) f is irreducible in $\mathbb{C}[[X, Y]]$.
- c) k and r are relatively prime.

If these conditions hold, the map

$$\mathbb{C} \rightarrow V(f) \subset \mathbb{C}^2, \quad t \mapsto (t^k, t^r),$$

is bijective.

Hint. f and its possible factors are quasihomogeneous in the sense of Section 7.3, with weights k and r ; hence at most polynomials of the form $cX^\mu Y^\nu$ can occur as factors of f . (See [Ku].)

8.2. We now prove a generalization of the theorem stated in Section 3.6.

Corollary. Let $f \in \mathbb{C}\langle X, Y \rangle$ be convergent in the bidisk

$$D = \{(x, y) \in \mathbb{C}^2 : |x| < \varrho, |y| < \sigma\}.$$

Suppose $f(0, 0) = 0$, and let

$$C = \{(x, y) \in D : f(x, y) = 0\}$$

be a representative of the germ of a curve. For a line L through 0 in \mathbb{C}^2 , the following conditions are equivalent:

- i) L is tangent to C at 0.
- ii) L is the limit of secants $0 \vee p_i$, where $p_i \in C$, $p_i \neq 0$, and $\lim p_i = p$.

- iii) L is the limit of tangents at smooth points $0 \neq p_i \in C$, where $\lim p_i = p$.

Proof. By Theorem 8.1, each branch has exactly one tangent. Hence it suffices to prove the assertion for an irreducible Weierstrass polynomial f . We assume that the tangent is described by $Y = 0$. Then the Puiseux parametrization has the form

$$t \mapsto \Phi(t) = (t^k, ct^r + \dots), \quad \text{where } 1 \leq k < r, c \neq 0.$$

(See Section 8.1.) For p close to 0 the direction of the secant $0 \vee p$ is given by

$$(t^k, ct^r + \dots) = t^k(1, ct^{r-k} + \dots),$$

where $t \neq 0$ is small. As $t \rightarrow 0$ this direction approaches $(0, 1)$, the direction of the tangent. The tangent at the point $\Phi(t)$ has direction

$$(kt^{k-1}, crt^{r-1} + \dots) = t^{k-1}(k, crt^{r-k} + \dots).$$

As $t \rightarrow 0$, these tangents also converge to the tangent $Y = 0$ at the origin. \square

8.3. As another application of the Puiseux theorems, we will now describe a method that is very well suited to computing intersection multiplicities (this was already used in the proof of the Plücker formulas in Section 5.9) and establishing theoretical properties (Theorem 3.5, for instance). Our goal is to define a number

$$\text{mult}(C, C')$$

as the *intersection multiplicity* of two germs of curves C and C' , in such a way that this function of two arguments has as many good properties as possible. (See Figure 8.1.)

The trick here is to describe the two arguments C and C' in different ways: C by an equation $f = 0$, and C' by a parametrization. First, it is important to choose f minimal in the sense of Section 6.14.

In the *first step*, we suppose $C' = L$ is a line. Let

$$C = V(f), \quad \text{where } f \in \mathbb{C}\langle X, Y \rangle \text{ is minimal,}$$

and let

$$T \mapsto (\lambda T, \mu T), \quad \text{where } (\lambda, \mu) \neq (0, 0),$$

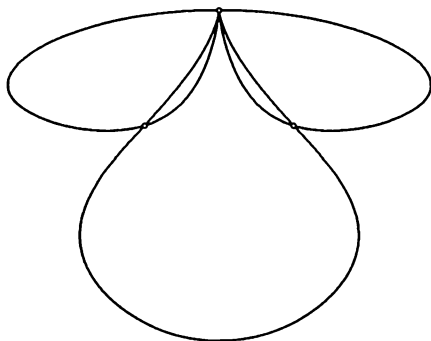

Figure 8.1

be a linear parametrization of L . We define

$$h(T) := f(\lambda T, \mu T) \quad \text{and} \quad \text{mult}(C, L) := \text{ord } h.$$

This is completely analogous to the elementary methods of Sections 1.7 and 2.5. To make the intersection multiplicity more understandable, we explain this definition in detail.

1) $\text{mult}(C, L)$ is independent of

- a) the equation of C ,
- b) the linear parametrization of L ,
- c) linear changes of coordinates in \mathbb{C}^2 .

Proof. a) f is minimal, hence uniquely determined up to a unit. The order of h is independent of the unit.

b) Any other linear parametrization of L is given by

$$T \mapsto (\varrho\lambda T, \varrho\mu T), \quad \text{where } \varrho \in \mathbb{C}^*.$$

Such a ϱ does not change the order of h .

c) We consider f and the parametrization $\phi(t) = (\lambda t, \mu t)$ as maps

$$V \xrightarrow{\phi} D \xrightarrow{f} \mathbb{C},$$

where $V \subset \mathbb{C}$ is open and $D \subset \mathbb{C}^2$ is a bidisk in which f converges. Then $h = f \circ \phi$ is holomorphic and independent of coordinates in

D. Hence the order of h as a power series is also independent of coordinates. \square

2) $\text{mult}(C, L)$ is “linear” in the first argument. In other words, if

$$C = C_1 \cup \cdots \cup C_r$$

is the decomposition into irreducible components, then

$$\text{mult}(C, L) = \text{mult}(C_1, L) + \cdots + \text{mult}(C_r, L).$$

Proof. If $C_i = V(f_i)$ and $h_i(T) := f_i(\lambda T, \mu T)$, then

$$h = h_1 \cdot \cdots \cdot h_r, \quad \text{so} \quad \text{ord } h = \text{ord } h_1 + \cdots + \text{ord } h_r. \quad \square$$

3) If L is described for $\lambda = 1$ by the equation $g(X, Y) = Y - \mu X$, and if $f \in \mathbb{C}\langle X \rangle[Y]$, then

$$\text{mult}(C, L) = \text{ord } R_{f,g}.$$

In other words, the intersection multiplicity can be computed by means of a resultant, as in Section 2.6.

Proof. If $f = a_0 Y^k + \cdots + a_k$, then

$$R_{f,g} = \det \begin{pmatrix} a_0 & a_1 & a_2 & \cdots & a_{k-1} & a_k \\ 1 & -\mu X & & & & \\ & & 1 & -\mu X & & \\ & & & & & \\ & & & & & \\ & & & & 1 & -\mu X \end{pmatrix}$$

$$= (-1)^k (a_0 (\mu X)^k + \cdots + a_k) = (-1)^k f(X, \mu X) = (-1)^k h(T).$$

The best way to expand the determinant is in terms of the first row. \square

4) If f is an irreducible Weierstrass polynomial and the tangent T to $C = V(f)$ is described by $Y = 0$, then the Puiseux pair (k, r) of Section 8.1 has the following interpretation:

$$\text{mult}(C, L) = \begin{cases} k, & \text{if } L \neq T, \\ r, & \text{if } L = T. \end{cases}$$

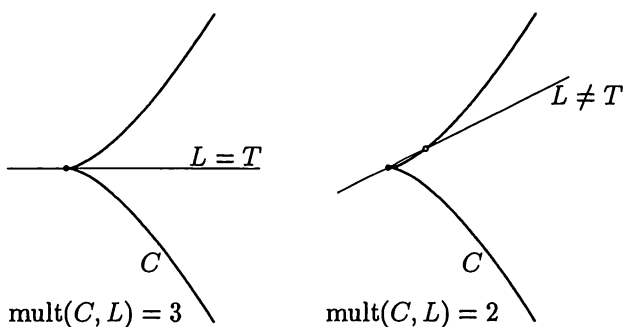

Figure 8.2

Proof. Let $f = Y^k + a_1(X)Y^{k-1} + \cdots + a_k(X)$ and $f_{(k)} = Y^k$ (see Section 8.1). Then $\text{ord } a_k = r$, and it follows from

$$h(T) = f(\lambda T, \mu T) = \mu^k T^k + \cdots + a_k(\lambda T)$$

that

$$\text{ord } h = \begin{cases} k, & \text{if } \mu \neq 0, \\ r, & \text{if } \mu = 0. \end{cases} \quad \square$$

5) If C is irreducible, then the process can be reversed, and a Puiseux parametrization of C can be substituted into an equation for L .

This goes as follows: If $\phi(t) = (t^k, \varphi(t))$, where $\varphi(t) = ct^r + \cdots$, $c \neq 0$, and if $g(X, Y) = \mu X - \lambda Y$ is an equation for L , let

$$\tilde{h} := g(t^k, \varphi(t)) = \mu t^k - \lambda ct^r + \cdots.$$

Then

$$\text{ord } \tilde{h} = \begin{cases} k, & \text{if } \mu \neq 0, \\ r, & \text{if } \mu = 0, \end{cases}$$

so $\text{mult}(C, L) = \text{ord } \tilde{h}$.

6) If the line L is varied for fixed C , then, in general, a multiple intersection point becomes several simple intersection points.

More precisely, this means the following: In the situation of (4), let $C = V(f)$, with tangent $Y = 0$ and Puiseux pair (k, r) . Let the

line L be parametrized by

$$T \mapsto (\lambda T + \varrho, \mu T), \quad \text{where } (\lambda, \mu) \neq (0, 0).$$

Now we consider

$$h(\lambda, \mu, \varrho, T) := f(\lambda T + \varrho, \mu T)$$

as a function of four variables. Before we can apply the preparation theorem, we have to put some restrictions on the variables (λ, μ, ϱ) .

a) We set $\mu = 1$ and keep λ fixed. This means that one of the lines L_0 through 0 that is not the tangent is shifted parallel to a line L_ϱ . For

$$h(\varrho, T) := f(\lambda T + \varrho, T), \quad \text{we have } \text{ord}_T h = k,$$

since f was assumed to be a Weierstrass polynomial. By the preparation theorem,

$$h(\varrho, T) = \alpha(\varrho, T)(T^k + \beta_1(\varrho)T^{k-1} + \cdots + \beta_k(\varrho)),$$

where α is a unit and $\beta_i \in \mathfrak{m}$. Geometrically, this means that for sufficiently general f and small $\varrho \neq 0$, the k -fold intersection point of C with the line L_0 splits into k simple intersection points of C with the line L_ϱ .

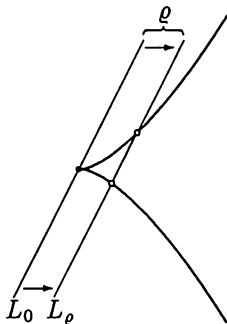

Figure 8.3. Shifting the line

b) Now we move the tangent. To do this, we set $\lambda = 1$. Then, for

$$h(\mu, \varrho, T) := f(T + \varrho, \mu T), \quad \text{we have } \text{ord}_T h(0, 0, T) = r,$$

so

$$h(\mu, \varrho, T) = \alpha(\mu, \varrho, T)(T^r + \beta_1(\mu, \varrho)T^{r-1} + \cdots + \beta_r(\mu, \varrho)).$$

This means that for small motions of the tangent, the r -fold intersection point splits, in general, into r simple intersection points.

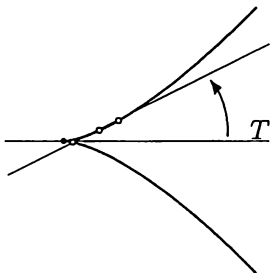

Figure 8.4. Moving the tangent

8.4. Now that the intersection multiplicity

$$\text{mult}(C, C')$$

has been defined when C is an arbitrary germ of a curve and C' is a line, we assume in the *second step* that C' is an irreducible germ. Such a germ can be parametrized by a Puiseux series, and this series can be used to define the intersection multiplicity, as in Section 8.3. We need some technical preliminaries.

Definition. Let an irreducible $g \in \mathbb{C}\langle X, Y \rangle$ and $\varphi_1, \varphi_2 \in \mathbb{C}\langle T \rangle$ be given. The pair $\Phi = (\varphi_1, \varphi_2)$ is called a *local parametrization* of the germ $V(g)$ if there exist neighborhoods of the origins $V \subset \mathbb{C}$ and $U \subset \mathbb{C}^2$ such that

- 1) φ_1, φ_2 are convergent in V and g is convergent in U ,
- 2) $\Phi(V) \subset C := V(g) \subset U$,
- 3) $\Phi : V \rightarrow C$ is bijective.

Theorem. Every irreducible germ of a curve admits a local parametrization. Any two local parametrizations $\Phi = (\varphi_1, \varphi_2)$ and $\Psi = (\psi_1, \psi_2)$

of the same germ $V(g)$ are equivalent; that is, there exists a series $\beta \in \mathbb{C}\langle T \rangle$ such that $\text{ord } \beta = 1$ and $\psi_i(\beta(T)) = \varphi_i(T)$ for $i = 1, 2$.

Proof. By the Weierstrass preparation theorem we may assume that g is a Weierstrass polynomial. Hence the existence of a local parametrization follows immediately from the Puiseux theorem of Section 7.8. By Lemma 6.6, we may assume that

$$\varphi_1(T) = T^k, \quad \text{where } k = \text{ord } g.$$

If $\varphi_i \in \mathbb{C}\langle T \rangle$ and $\psi_i \in \mathbb{C}\langle T \rangle$, then by Corollary 7.7 we may assume that

$$\varphi_1(T) = T^k \quad \text{and} \quad \psi_1(S) = S^l.$$

It follows from condition (3) that $k = l$. By Corollary 7.10, there is a k th root of unity ζ such that

$$\psi_2(\zeta T) = \varphi_2(T).$$

Hence it suffices to combine the change of parameters

$$S = \zeta T = \beta(T)$$

with the transformations from Sections 6.6 and 7.7. □

Definition. Let C and C' be germs of curves, let $C = V(f)$ with minimal $f \in \mathbb{C}\langle X, Y \rangle$, and let C' be irreducible, with local parametrization $\Phi = (\varphi_1, \varphi_2)$. Then the intersection multiplicity is defined by

$$\text{mult}(C, C') := \text{ord}_T f(\varphi_1(T), \varphi_2(T)).$$

Remark. *This definition is independent of*

- a) linear changes of coordinates in \mathbb{C}^2 ,
- b) the equation f of C ,
- c) the local parametrization Φ of C' .

Proof. a) is clear, since linear transformations preserve all orders.

b) is clear, since f is unique up to a unit in $\mathbb{C}\langle X, Y \rangle$.

c) follows from the theorem above, since a change of parameters β with $\text{ord } \beta = 1$ preserves the orders. □

8.5. Now, in the *third step*, we can generalize the intersection multiplicity $\text{mult}(C, C')$ of two germs of curves to arbitrary arguments C and C' by extending linearly. It is often useful, and takes no more effort, to do this immediately for divisors C and C' . Let $f, g \in \mathbb{C}\langle X, Y \rangle$, with prime factorizations

$$f = f_1^{r_1} \cdots f_m^{r_m}, \quad g = g_1^{s_1} \cdots g_n^{s_n}.$$

Then (in the sense of divisors; see Section 6.15)

$$C = V(f) = r_1 V(f_1) + \cdots + r_m V(f_m),$$

$$C' = V(g) = s_1 V(g_1) + \cdots + s_n V(g_n).$$

If $C_i := V(f_i)$ and $C'_j := V(g_j)$, we define

$$\text{mult}(C, C') := \sum_{i,j=1}^{m,n} r_i s_j \text{mult}(C_i, C'_j).$$

Here $\text{mult}(C_i, C'_j)$ is defined as in Section 8.4. Since C_i is given in this definition by an equation, and C'_j by a parametrization, it is not at all clear that the intersection multiplicity is symmetric in the two arguments. This and much more are consequences of the following basic lemma (see [Wa]).

Lemma. *If $f, g \in \mathbb{C}\langle X \rangle[Y]$ are Weierstrass polynomials with resultant $R_{f,g} \in \mathbb{C}\langle X \rangle$, then*

$$\text{mult}(V(f), V(g)) = \text{ord } R_{f,g}.$$

Proof. By the definition of multiplicity and the properties of the resultant given in Appendix 1, we may assume for simplicity that f and g are irreducible. Let $k = \deg f$, $l = \deg g$, $\zeta = \exp 2\pi i/k$, and $\xi = \exp 2\pi i/l$. Let

$$S \mapsto (S^k, \varphi(S)), \quad T \mapsto (T^l, \psi(T))$$

be Puiseux parametrizations of C and C' as in Section 7.8. By Section 7.10,

$$f(X, Y) = \prod_{\kappa=1}^k \left(Y - \varphi(\zeta^\kappa X^{\frac{1}{k}}) \right),$$

$$g(X, Y) = \prod_{\lambda=1}^l \left(Y - \psi(\xi^\lambda X^{\frac{1}{l}}) \right).$$

Let

$$h(T) := f(T^l, \psi(T)) = aT^p + \dots,$$

where $a \neq 0$ and $p = \text{ord}_T h$. Then

$$h_\lambda(T) := f(T^l, \psi(\xi^\lambda T)) = a\xi^{p\lambda} T^p + \dots$$

for $\lambda = 1, \dots, l$. Since

$$h_1(T) \cdot \dots \cdot h_l(T) = bT^{pl} + \dots = bX^p + \dots, \quad \text{where } b \neq 0,$$

we have

$$\text{ord}_T h = \text{ord}_X (h_1 \cdot \dots \cdot h_l).$$

These equations, together with Section A.1.4, give

$$\begin{aligned} \text{mult}(V(f), V(g)) &= \text{ord}_T h = \text{ord}_X (h_1 \cdot \dots \cdot h_l) \\ &= \text{ord}_X \prod_{\lambda=1}^l f(X, \psi(\xi^\lambda T)) \\ &= \text{ord}_X \prod_{\lambda=1}^l \prod_{\kappa=1}^k \left(\psi(\xi^\lambda X^{\frac{1}{l}}) - \varphi(\zeta^\kappa X^{\frac{1}{k}}) \right) \\ &= \text{ord}_X R_{f,g}. \end{aligned} \quad \square$$

Since $R_{g,f} = \pm R_{f,g}$, there is an immediate corollary.

Corollary. *If C, C' are germs of curves, then*

$$\text{mult}(C, C') = \text{mult}(C', C).$$

8.6. The methods of Section 8.5 yield another important result.

Theorem. *If C, C' are germs of curves, then*

$$\text{mult}(C, C') \geq \text{ord } C \cdot \text{ord } C'.$$

Equality holds if and only if C and C' do not have a common tangent.

Proof. Again, we may assume that C and C' are irreducible; that $C = V(f)$ and $C' = V(g)$, where f and g are Weierstrass polynomials; and that the coordinates are chosen as in Section 6.7 so that

$$\text{ord } C = \deg f =: k \quad \text{and} \quad \text{ord } C' = \deg g =: l.$$

We may also assume that the line $Y = 0$ is not tangent to C or C' . According to Section 8.1, with these assumptions the Puiseux parametrizations have the form

$$\begin{aligned} S &\mapsto (S^k, \varphi(S)), & \text{where } \varphi(S) &= aS^k + \cdots, & a \neq 0, \\ T &\mapsto (T^l, \psi(T)), & \text{where } \psi(T) &= bT^l + \cdots, & b \neq 0. \end{aligned}$$

The equations of the tangents are then $Y = aX$ and $Y = bX$. It follows that

$$\prod_{\lambda=1}^l \prod_{\kappa=1}^k \left(\psi(\xi^\lambda X^{\frac{1}{l}}) - \varphi(\zeta^\kappa X^{\frac{1}{k}}) \right) = (b-a)^{kl} X^{kl} + \cdots,$$

so

$$\text{mult}(C, C') = kl \text{ if } a \neq b, \text{ and } \text{mult}(C, C') > kl \text{ if } a = b. \quad \square$$

8.7. Now we finally have all the tools we need to compare the intersection multiplicity of algebraic curves defined in Section 2.7 with the intersection multiplicity of germs introduced in this chapter.

Let $C = V(F)$, $C' = V(G) \subset \mathbb{P}_2(\mathbb{C})$ be two algebraic curves, and let $p \in C \cap C'$. The intersection multiplicity of C and C' at p ,

$$\text{mult}_p(C \cap C'),$$

was defined in Section 2.7 by means of a resultant. But we could also consider the germs C_p and C'_p of C and C' at p . Let

$$\text{mult}(C_p \cap C'_p)$$

denote the intersection multiplicity described in this chapter. The result one might hope for turns out to be true ([Wa], IV §5).

Theorem. *With the notation and hypotheses above,*

$$\text{mult}_p(C \cap C') = \text{mult}(C_p \cap C'_p).$$

Proof. First we have to recall which special coordinates were chosen in Section 2.7. Since $(0 : 0 : 1) \notin C \cup C'$, we were able to choose

$$F = X_2^m + A_1 X_2^{m-1} + \cdots + A_m, \quad G = X_2^n + B_1 X_2^{n-1} + \cdots + B_n,$$

$$\text{where } A_i, B_j \in \mathbb{C}[X_0, X_1], \quad \deg A_i = i, \quad \deg B_j = j.$$

Let $R \in \mathbb{C}[X_0, X_1]$ denote the resultant of F and G . By Theorem A.1.3 it is homogeneous of degree $m \cdot n$. We may further assume that

no point of intersection of C and C' lies on the line $X_0 = 0$. Hence $R(0, 1) \neq 0$, so

$$R'(X_1) := R(1, X_1) \in \mathbb{C}[X_1]$$

has degree $m \cdot n$, and R' is the resultant of

$$f(X_1) = F(1, X_1) \quad \text{and} \quad g(X_1) = G(1, X_1).$$

Since all the points of intersection of C and C' are contained in the affine space $\mathbb{C}^2 \subset \mathbb{P}_2(\mathbb{C})$, we may assume that

$$C = V(f), \quad C' = V(g) \subset \mathbb{C}^2.$$

Here

$$f = X_2^m + a_1 X_2^{m-1} + \cdots + a_m, \quad g = X_2^n + b_1 X_2^{n-1} + \cdots + b_n,$$

where $a_i, b_j \in \mathbb{C}[X_1]$.

Finally, it was assumed in Section 2.7 that every line $X_1 = x_1$ contained at most one point of intersection of C and C' . If the line $X_1 = x_1$ contained a point of intersection p , we defined

$$\text{mult}_p(C \cap C') = \text{ord}_{x_1} R'(X_1).$$

To simplify notation we choose $p = (0, 0)$, so $x_1 = 0$, and set $X_1 = X$, $X_2 = Y$. As in Section 7.12, we consider

$$f_0 = f(0, Y) = Y^k(Y - c_2)^{k_2} \cdots (Y - c_r)^{k_r},$$

$$g_0 = g(0, Y) = Y^l(Y - d_2)^{l_2} \cdots (Y - d_s)^{l_s},$$

where $k, l \geq 1$ and $c_2, \dots, c_r, d_2, \dots, d_s$ are distinct and nonzero. As was proved in Section 7.12, there exist

$$\varphi_1, \dots, \varphi_m, \psi_1, \dots, \psi_n \in \mathbb{C}[[X^*]]$$

such that

$$f = (Y - \varphi_1) \cdots (Y - \varphi_m), \quad g = (Y - \psi_1) \cdots (Y - \psi_n)$$

and

$$\begin{aligned} \text{ord } \varphi_i, \text{ ord } \psi_j &> 0 & \text{for } i = 1, \dots, k, \quad j = 1, \dots, l, \\ \text{ord } \varphi_i, \text{ ord } \psi_j &= 0 & \text{for } i = k + 1, \dots, m, \quad j = l + 1, \dots, n. \end{aligned}$$

Now we turn to the resultants. By Appendix 1.4,

$$R' = \prod_{i=1}^m \prod_{j=1}^n (\varphi_i - \psi_j) \in \mathbb{C}[[X]]. \quad (*)$$

The germs of C and C' at 0 are given by

$$\begin{aligned}\tilde{f} &= (Y - \varphi_1) \cdots (Y - \varphi_k) \in \mathbb{C}\langle X \rangle[Y], \\ \tilde{g} &= (Y - \psi_1) \cdots (Y - \psi_l) \in \mathbb{C}\langle X \rangle[Y].\end{aligned}$$

Letting $\tilde{R} \in \mathbb{C}\langle X \rangle$ denote the resultant of \tilde{f} and \tilde{g} , we have, again by Appendix 1.4,

$$\tilde{R} = \prod_{i=1}^k \prod_{j=1}^l (\varphi_i - \psi_j) \in \mathbb{C}\langle X \rangle. \quad (**)$$

By Lemma 8.5, the equality of multiplicities that is to be proved means that

$$\text{ord}_0 R' = \text{ord}_0 \tilde{R}.$$

By (*) and (**), \tilde{R} is a divisor of F' in $\mathbb{C}\llbracket X^* \rrbracket$, so $R' = S \cdot \tilde{R}$ and it suffices to show that

$$\text{ord } S = 0.$$

The factors of S are of the form

$$(\varphi_i - \psi_j), \quad \text{where } i > k \text{ or } j > l.$$

The possible initial terms of φ_i , $i > k$, are c_2, \dots, c_r ; for ψ_j , $j > l$, they are d_2, \dots, d_s . Hence every such difference has a nonzero initial term, so

$$\text{ord}(\varphi_i - \psi_j) = 0$$

for every such factor of S . □

The proof of this theorem belatedly justifies the computations of the intersection multiplicities in the proof of the Plücker formulas in Section 5.9. But not only that; through this theorem, Bézout's theorem gains a deeper meaning. It is a kind of *local-global principle*: The local invariants, the intersection multiplicities, add up to a globally prescribed number, the product of the degrees.

The Riemann Surface of an Algebraic Curve

In earlier chapters we were able to give *rational parametrizations* of several curves $C \subset \mathbb{P}_2(\mathbb{C})$. A rational parametrization is a map

$$\varphi : \mathbb{P}_1(\mathbb{C}) \rightarrow C$$

that is bijective away from the singularities of C . In this last chapter we will show that such a parametrization always exists if we admit an arbitrary compact Riemann surface S instead of $\mathbb{P}_1(\mathbb{C})$. This S is uniquely determined by C , up to a biholomorphism; it can be called the *resolution of singularities* of C . It leads to a better understanding of many properties of plane curves—the estimate of the number of singular points in Section 3.8, for instance, or the duality in Section 5.3. In particular, the Plücker formulas appear in a clearer light and a more general setting.

9.1. First we briefly list the necessary facts about Riemann surfaces. For details and proofs, we refer the reader to the literature ([Fo2], for example).

Definition. A Riemann surface is a connected Hausdorff topological space S , together with a *complex atlas*

$$(\psi_i : V_i \rightarrow U_i)_{i \in I}.$$

This means that for all $i \in I$, the sets $V_i \subset \mathbb{C}$, $U_i \subset S$ are open and the maps ψ (the *charts*) are homeomorphisms, and for all $i, j \in I$ the

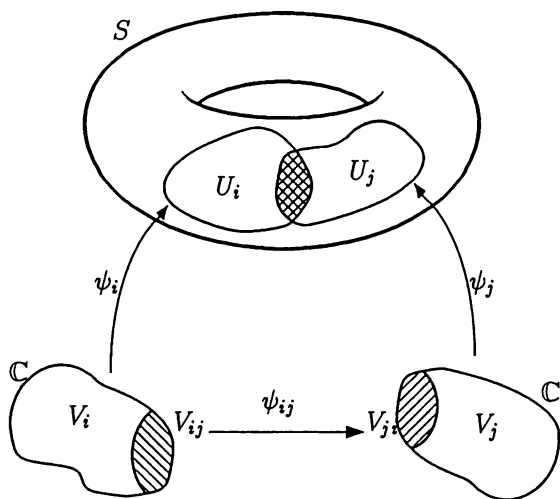

Figure 9.1. Charts on a Riemann surface

transition functions

$$\psi_{ij} : V_{ij} = \psi_i^{-1}(U_i \cap U_j) \rightarrow V_{ji} = \psi_j^{-1}(U_i \cap U_j)$$

are biholomorphic.

A map

$$\varphi : S \rightarrow T$$

between Riemann surfaces is called *holomorphic* if it is described by holomorphic functions when viewed in the charts.

A Riemann surface S is a manifold of complex dimension one, so of real dimension two. Using the Cauchy-Riemann differential equations, one can see that the real Jacobian matrix of the ψ_{ij} has positive determinant. Hence S is orientable as a real surface.

It is known from topology that any compact orientable *surface* (two-dimensional topological manifold) is homeomorphic to a sphere with g handles. The number $g \in \mathbb{N}$ is called the *genus* of the surface (see [M]).

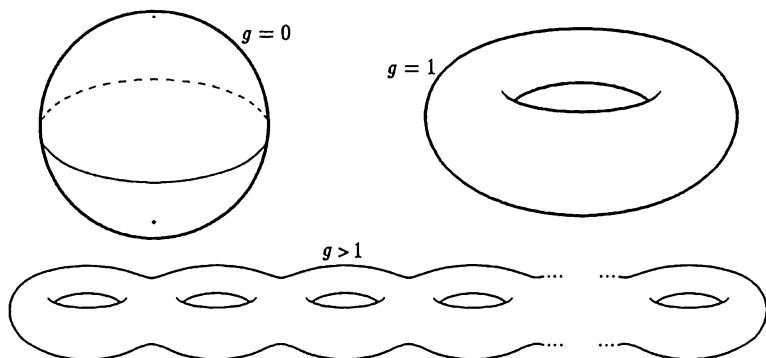
Figure 9.2. Surfaces of genus g

9.2. It is not hard to construct a complex atlas on a sphere with g handles for any $g \in \mathbb{N}$. As a break from so much algebra, the procedure will be sketched here.

For $g = 0$, $S = \mathbb{P}_1(\mathbb{C})$ is the Riemann sphere with two charts, where

$$U_0 = \mathbb{P}_1(\mathbb{C}) \setminus \{(0 : 1)\}, \quad U_1 = \mathbb{P}_1(\mathbb{C}) \setminus \{(1 : 0)\}.$$

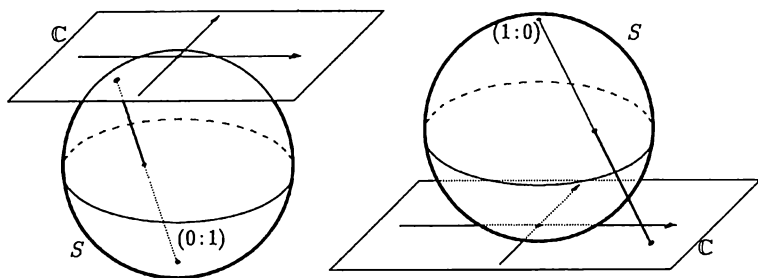

Figure 9.3. The Riemann sphere and its two charts

For $g \geq 1$, we start with a regular $4g$ -gon $P \subset \mathbb{R}^2 = \mathbb{C}$ with edges

$$a_1, b_1, a'_1, b'_1, \dots, a_g, b_g, a'_g, b'_g,$$

which are arranged and oriented as follows: On the boundary of P , if we identify the edges a_i with a'_i and b_i with b'_i , oriented as in Figure

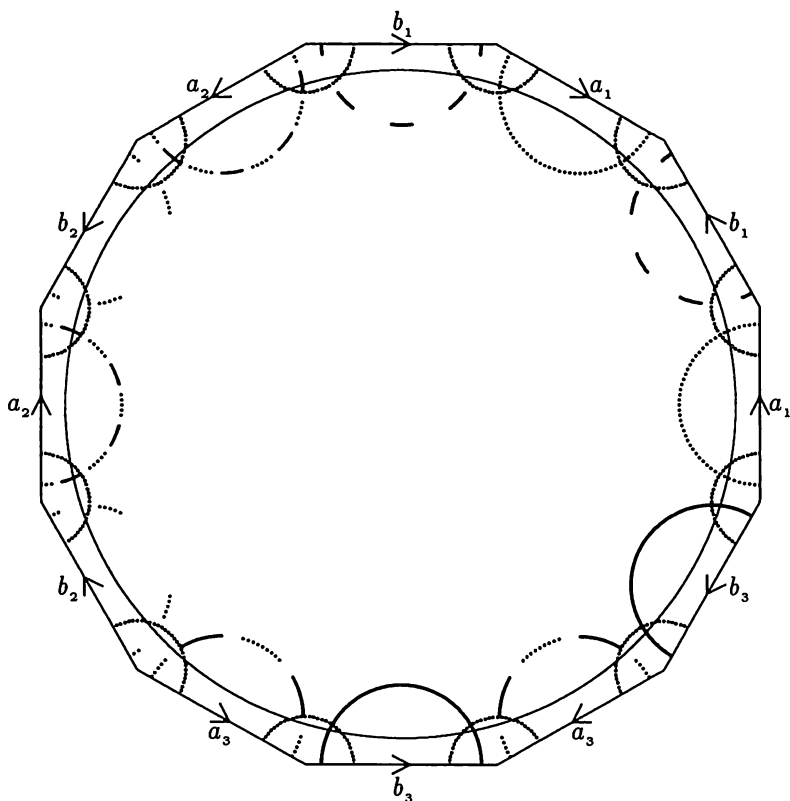

Figure 9.4. A fundamental polygon of a Riemann surface of genus $g = 3$

9.4, we obtain a surface S of genus g . All the corners of P become a point $o \in S$, and the edges a_i and b_i become closed paths α_i and β_i based at o . The path

$$\alpha_1 \beta_1 \alpha_1^{-1} \beta_1^{-1} \cdots \alpha_g \beta_g \alpha_g^{-1} \beta_g^{-1} \quad \text{in } S$$

is null-homotopic because it corresponds to the boundary of P and can be contracted through the interior of P . Now let

$$U_0, U_1, \dots, U_g, U_{g+1}, \dots, U_{2g}, U_{2g+1}$$

be the open sets in S defined by means of their preimages \tilde{U}_i in P . Here o is contained only in U_0 , U_i intersects only α_i , U_{g+i} intersects

only β_i , and U_{2g+1} intersects none of the paths. So in P we have the following:

\tilde{U}_{2g+1} is connected,

\tilde{U}_i has two connected components for $i = 1, \dots, 2g$,

\tilde{U}_0 splits into $4g$ connected components.

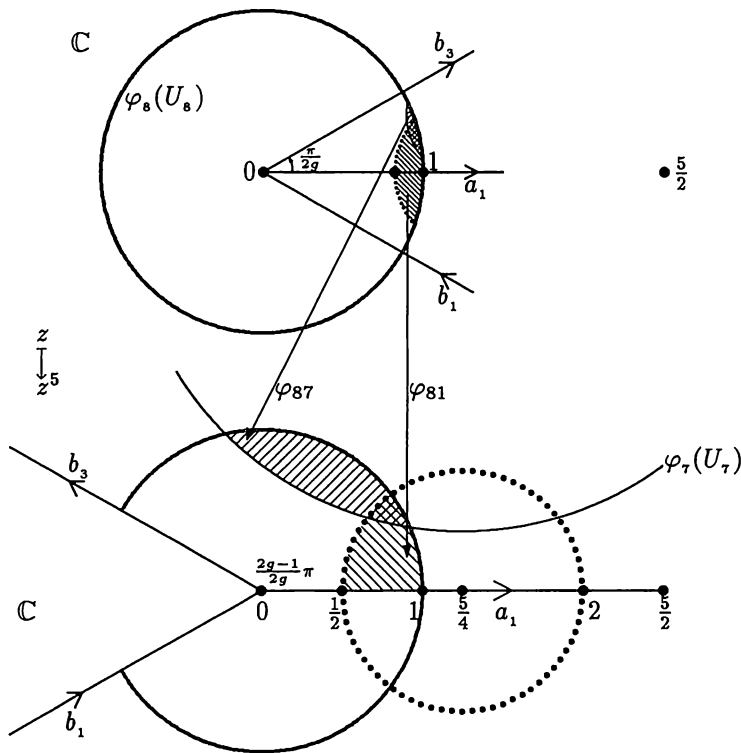

Figure 9.5. Transition functions for a Riemann surface of genus $g = 3$

Now we turn to the construction of the charts

$$\psi_i : V_i \rightarrow U_i.$$

For $i = 2g + 1$, we can choose V_{2g+1} to be \tilde{U}_{2g+1} and ψ_{2g+1} to be the restriction of the canonical map $P \rightarrow S$. For $i = 1, \dots, 2g$, we choose

the V_i to be disks. If we map two halves to the two components of \tilde{U}_i , we obtain ψ_i . For $i = 0$ we divide a disk of suitable radius into $4g$ equal sectors. These have central angle $\varphi = \pi/2g$ and the components of \tilde{U}_0 have central angle $(2g - 1)\varphi$, so we can assemble ψ_0 from translations and $(2g - 1)$ st powers. The resulting transition functions are biholomorphic. We have proved the following result.

Theorem. *For every $g \in \mathbb{N}$, a compact, orientable surface of genus g can be made into a Riemann surface.*

The complex structure is unique only for $g = 0$ (see [Fo2], 16.13). The set of *complex structures* (i.e. the biholomorphic equivalence classes of atlases) has one complex parameter for $g = 1$, and $3g - 3$ complex parameters for $g \geq 2$. The space of these parameters is called *Teichmüller space*. With the construction above, at least we have determined one point in it.

9.3. Riemann surfaces have complex dimension one; complex manifolds of dimension n can be defined in exactly the same way. For $n = 2$, we construct an atlas on $\mathbb{P}_2(\mathbb{C})$ consisting of three charts. For $i = 0, 1, 2$, let

$$U_i := \{(x_0 : x_1 : x_2) \in \mathbb{P}_2(\mathbb{C}) : x_i \neq 0\}$$

and let $V_i = \mathbb{C}^2$. For $i = 0$, the chart ψ_0 is given by

$$\psi_0 : \mathbb{C}^2 \rightarrow U_0, \quad (y_1, y_2) \mapsto (1 : y_1 : y_2),$$

and similarly for $i = 1, 2$. For practice, the reader is invited to check that the resulting transition functions ψ_{ij} are biholomorphic.

Thus, for a Riemann surface S , it is clear when a map

$$\varphi : S \rightarrow \mathbb{P}_2(\mathbb{C})$$

is holomorphic: one checks it in the local charts. If $C \subset \mathbb{P}_2(\mathbb{C})$ is an algebraic curve, a map

$$\varphi : S \rightarrow C$$

is called holomorphic if it is holomorphic as a map to $\mathbb{P}_2(\mathbb{C})$. With these preliminaries out of the way, we can state the theorem.

Theorem. For every irreducible algebraic curve $C \subset \mathbb{P}_2(\mathbb{C})$, there exist a compact Riemann surface S and a holomorphic map

$$\varphi : S \rightarrow C$$

with the following properties:

- i) Let $C' := C \setminus \text{Sing } C$ be the smooth part of C , and let $S' := \varphi^{-1}(C') \subset S$. Then

$$\varphi' := \varphi|_{S'} : S' \rightarrow C'$$

is biholomorphic.

- ii) For every $p \in C$ there is a bijective map

$$\varphi^{-1}(p) \rightarrow \{\text{branches of } C \text{ at } p\}.$$

In particular, $\varphi^{-1}(p)$ is finite for every p .

A Riemann surface S with properties (i) and (ii) is uniquely determined up to biholomorphic equivalence. $\varphi : S \rightarrow C$ is called the *resolution of singularities* of C .

Consequence. For any irreducible curve $C \subset \mathbb{P}_2(\mathbb{C})$, we can define the *genus*

$$g(C) := \text{genus of } S.$$

C is said to be *rational* if $g(C) = 0$.

Remark. The theorem produces a Riemann surface for every plane curve. Conversely, as a consequence of the Riemann-Roch theorem, every compact Riemann surface S can be realized as a smooth algebraic curve $S \subset \mathbb{P}_3(\mathbb{C})$. If we choose a suitable point $z \in \mathbb{P}_3(\mathbb{C}) \setminus S$ as center, we obtain a projection

$$\pi : \mathbb{P}_3(\mathbb{C}) \setminus \{z\} \rightarrow \mathbb{P}_2(\mathbb{C})$$

such that

$$\varphi|_S : S \rightarrow C := \pi(S)$$

is biholomorphic almost everywhere (see [H], Ch. IV). Thus every compact Riemann surface occurs as the desingularization of a plane algebraic curve C . The projection can even be chosen so that C is a Plücker curve and has at most simple double points as singularities (see Section 5.7).

9.4. For the *proof of Theorem 9.3* we first construct a Riemann surface S . This is done by patching together a large number of open sets $V \subset \mathbb{C}$.

If $p \in C'$, then by the implicit function theorem (Section 6.9) there exist an open set $V_p \subset \mathbb{C}$, a neighborhood $p \in W_p \subset \mathbb{P}_2$, and a biholomorphic map

$$\psi_p : V_p \rightarrow C \cap W_p \subset C'.$$

For each $q \in \text{Sing } C$, we choose a neighborhood $q \in W_q \subset \mathbb{P}_2$ such that the W_q are pairwise disjoint and

$$C \cap W_q = C_{q,1} \cup \cdots \cup C_{q,k_q},$$

where the $C_{q,i}$ are representatives of the branches of C at q (see Section 6.14). In particular, let

$$C_{q,i} \cap C_{q,j} = \{q\} \quad \text{for } i \neq j.$$

Further, let W_q be chosen so small that for every i there is a Puiseux parametrization

$$\psi_{q,i} : V_{q,i} \rightarrow C_{q,i},$$

where $V_{q,i} \subset \mathbb{C}$ is open. Now we take the *disjoint* union of all the open subsets in \mathbb{C} obtained above:

$$M := \bigcup_{p \in C'} V_p \cup \bigcup_{q \in \text{Sing } C} V_{q,1} \cup \cdots \cup V_{q,k_q}.$$

The maps ψ_p and $\psi_{q,i}$ together yield a holomorphic map

$$\psi : M \rightarrow C.$$

Now things are patched together in M as follows: for $p, p' \in C'$ and $q \in \text{Sing } C$, we have

$$v \in V_p \text{ and } v' \in V_{p'} \text{ are equivalent} \iff \psi_p(v) = \psi_{p'}(v') \in C',$$

$$v \in V_p \text{ and } v' \in V_{q,i} \text{ are equivalent} \iff \psi_p(v) = \psi_{q,i}(v') \in C'.$$

There is no patching between the sets $V_{q,i}$ and $V_{q,j}$. Let S denote the quotient of M by the equivalence relation given above, endowed with the quotient topology. The map ψ induces a map

$$\varphi : S \rightarrow C.$$

We must show that it has all the properties stated in the theorem.

a) $\varphi' : S' \rightarrow C'$ is bijective: This follows from the construction.

b) S is a Hausdorff space: The proof must be broken into cases and is left to the reader.

c) S is compact: Let

$$S = \bigcup_{i \in I} U_i, \quad \text{where } U_i \subset S \text{ are open.}$$

We use the compactness of C , but have to work a bit harder because the sets $\varphi(U_i) \subset C$ need not be open. Since the exceptional set $A := \varphi^{-1}(\text{Sing } C) \subset S$ is finite, it is compact. We define

$$I_0 := \{i \in I : U_i \cap A \neq \emptyset\}, \quad I_1 := I \setminus I_0.$$

Since

$$A \subset \bigcup_{i \in I_0} U_i,$$

there exists a finite subset $J_0 \subset I_0$ such that

$$A \subset \bigcup_{i \in J_0} U_i =: U.$$

A is finite, so $\varphi(U)$ is open. We define $U'_i := U_i \setminus A$ for $i \in I_0 \setminus J_0$. This gives the open cover

$$C = \varphi(U) \cup \bigcup_{i \in I_0 \setminus J_0} \varphi(U'_i) \cup \bigcup_{i \in I_1} \varphi(U_i).$$

Since C is compact, there exist finite subsets $I'_0 \subset I_0 \setminus J_0$ and $J_1 \subset I_1$ such that

$$C = \varphi(U) \cup \bigcup_{i \in I'_0} \varphi(U'_i) \cup \bigcup_{i \in J_1} \varphi(U_i).$$

Setting $I^* := J_0 \cup I'_0 \cup J_1 \subset I$ gives

$$S = \bigcup_{i \in I^*} U_i.$$

d) S is connected: Here we use the irreducibility of C . More generally, it can be shown that to every irreducible component of C there corresponds a connected component of S .

Let $C = V(F)$, where $F \in \mathbb{C}[X_0, X_1, X_2]$ is a homogeneous, irreducible polynomial of degree $n \geq 1$. We may assume that the point $q = (0 : 0 : 1) \notin C$. Then, up to a factor in \mathbb{C}^* ,

$$F = X_2^n + A_1 X_2^{n-1} + \cdots + A_n, \quad \text{where } A_i \in \mathbb{C}[X_0, X_1], \deg A_i = i.$$

Consider the maps

$$S \xrightarrow{\varphi} C \xrightarrow{\pi} \mathbb{P}_1(\mathbb{C}),$$

where π denotes the projection with center q . Let $\Delta_F \in \mathbb{C}[X_0, X_1]$ be the discriminant of F (see Section A.1.2). Δ_F is homogeneous by Theorem A.1.3, so we can define the exceptional set

$$B := V(\Delta_F) \subset \mathbb{P}_1(\mathbb{C}).$$

Since F is irreducible, $\Delta_F \neq 0$; hence B is finite. Let

$$C^* := C \setminus \pi^{-1}(B), \quad \pi^* := \pi|_{C^*} : C^* \rightarrow \mathbb{P}_1(\mathbb{C}) \setminus B.$$

Now it is easy to see that $C^* \subset C'$ and that π^* is an n -fold covering (see Section 7.9). Suppose there is a connected component $T \subset S$ with $\emptyset \neq T \neq S$. Since the exceptional set

$$\tilde{B} := \varphi^{-1}(\pi^{-1}(B)) \subset S$$

is finite, $T^* := T \setminus \tilde{B}$ is connected. Hence

$$D := \varphi(T^*) \subset C^*$$

is connected. By Remark 2 of Section A.2.1,

$$\eta := \pi|_D : D \rightarrow \mathbb{P}_1(\mathbb{C}) \setminus B$$

is itself a covering. Let m be the sheet number of η . Since φ' is bijective, it follows that $0 < m < n$.

It will now be shown that F must have a factor G of degree m . To make the construction of G clear, we first modify the given F slightly. Consider the two embeddings

$$\iota : \mathbb{C} \times \mathbb{C} \rightarrow \mathbb{P}_2(\mathbb{C}), \quad (y_1, y_2) \mapsto (1 : y_1 : y_2);$$

$$\tilde{\iota} : \mathbb{C} \times \mathbb{C} \rightarrow \mathbb{P}_2(\mathbb{C}), \quad (z_0, z_2) \mapsto (z_0 : 1 : z_2).$$

We have the corresponding transformations

$$Y_1 = \frac{X_1}{X_0}, \quad Y_2 = \frac{X_2}{X_0} \quad \text{and} \quad Z_0 = \frac{X_0}{X_1}, \quad Z_2 = \frac{X_2}{X_1}.$$

From F we obtain the polynomials

$$f(Y_1, Y_2) := F(1, Y_1, Y_2) = \sum_{i=0}^n a_i Y_2^{n-i},$$

$$\tilde{f}(Z_0, Z_2) := F(Z_0, 1, Z_2) = \sum_{i=0}^n \tilde{a}_i Z_2^{n-i},$$

where

$$a_i \in \mathbb{C}[Y_1], \quad \tilde{a}_i \in \mathbb{C}[Z_0], \quad \deg a_i, \deg \tilde{a}_i \leq i, \quad \text{and}$$

$$X_0^i a_i \left(\frac{X_1}{X_0} \right) = X_1^i \tilde{a}_i \left(\frac{X_0}{X_1} \right) = A_i(X_0, X_1). \quad (*)$$

For the affine parts of C , we have

$$C_0 := \iota^{-1}(C) = V(f) \quad \text{and} \quad \tilde{C}_0 := \tilde{\iota}^{-1}(C) = V(\tilde{f}).$$

The projection π with center q is given in affine coordinates by

$$\begin{array}{ccc} \iota^{-1}(C^*) & = & C_0^* \subset \mathbb{C} \times \mathbb{C}, \quad (y_1, y_2) \\ & & \downarrow \pi_0^* \qquad \qquad \downarrow \qquad \downarrow \\ & & \mathbb{C} \setminus B_0 \subset \mathbb{C}, \quad y_1. \end{array}$$

Here B_0 is the affine part of the exceptional set B . Since the map π_0^* is a restriction of π^* , it is itself a covering. Hence for every point $p \in \mathbb{C} \setminus B_0$ there exist a neighborhood W and bounded holomorphic functions $\psi_i \in \mathcal{O}(W)$ such that

$$f(Y_1, Y_2) = \prod_{i=1}^n (Y_2 - \psi_i(Y_1)) \quad \text{in } W \times \mathbb{C}.$$

The coefficients of f are the elementary symmetric functions:

$$a_i = s_i(\psi_1, \dots, \psi_n) \quad \text{in } W.$$

Similarly, we obtain

$$\tilde{f}(Z_0, Z_2) = \prod_{i=1}^n (Z_2 - \tilde{\psi}_i(Z_0)), \quad \tilde{a}_i = s_i(\tilde{\psi}_1, \dots, \tilde{\psi}_n),$$

in the Z -coordinates. Now, reversing this computation, we can start with the connected component $D \subset C^*$ and produce a factor G of F . To do this, for some $p \in \mathbb{C} \setminus B_0$, let the ψ_i be numbered so that

$$(x, \psi_i(x)) \in D \quad \text{for } i = 1, \dots, m \text{ and } x \in W.$$

We then define

$$g(Y_1, Y_2) := \prod_{i=1}^m (Y_2 - \psi_i(Y_1)) \quad \text{in } W \times \mathbb{C}.$$

The coefficients of g are given by the elementary symmetric functions t_1, \dots, t_m in m variables:

$$g = Y_2^m + b_1(Y_1)Y_2^{m-1} + \dots + b_m(Y_1), \quad b_j = t_j(\psi_1, \dots, \psi_m).$$

By the symmetry of the t_j , we thus obtain functions b_j that are holomorphic in $\mathbb{C} \setminus B_0$. Since $q \notin C$, the ψ_i are still bounded in B_0 , so the b_j can be extended holomorphically to \mathbb{C} .

We claim that the b_j are actually polynomials. To show this, we exploit the fact that, proceeding as above, we can obtain a function

$$\tilde{g}(Z_0, Z_2) = Z_2^m + \tilde{b}_1(Z_0)Z_2^{m-1} + \dots + \tilde{b}_m(Z_0)$$

in the Z -coordinates, with holomorphic \tilde{b}_j . By construction, we have an analogue of (*):

$$X_0^j b_j \left(\frac{X_1}{X_0} \right) = X_1^j \tilde{b}_j \left(\frac{X_0}{X_1} \right). \quad (**)$$

This means that at the point ∞ , where $X_0 = 0$, each entire function b_j has at most a pole of order j . Hence the b_j are polynomials of degree $\leq j$. Thus

$$B_j(X_0, X_1) := X_0^j b_j \left(\frac{X_1}{X_0} \right) \in \mathbb{C}[X_0, X_1]$$

is homogeneous of degree j , and by construction

$$G := X_2^m + B_1 X_2^{m-1} + \dots + B_m$$

is a proper divisor of F . But this contradicts the irreducibility of F . We have proved assertion (d).

The rest of the proof is routine and recommended to the reader as an exercise. To prove the uniqueness of S , use the Riemann extension theorem for holomorphic functions. \square

9.5. The fact that S is connected, which just cost us some effort to prove, has an important consequence.

Corollary. *Every irreducible algebraic curve $C' \subset \mathbb{C}^2$ is connected.*

Proof. Let $C \subset \mathbb{P}_2(\mathbb{C})$ be the projective closure, and let

$$\varphi : S \rightarrow C$$

be a resolution of singularities. $C \setminus C'$ is finite; hence so is $\varphi^{-1}(C \setminus C')$. Thus $S' := \varphi^{-1}(C')$ is connected. Since $C' = \varphi(S')$, the assertion follows. \square

Exercise. Every algebraic curve $C \subset \mathbb{P}_2(\mathbb{C})$ is connected.

9.6. In the Plücker formulas of Chapter 5, we established relationships among a series of invariants of an algebraic curve. Now a new invariant, the *genus*, has appeared through the resolution of singularities. In the following sections we investigate how it behaves with respect to the other invariants—in particular, how it can be computed from the degree and the invariants of the singularities. We begin by recalling a few well-known facts from the theory of Riemann surfaces.

Let S, T be compact Riemann surfaces, and let

$$\chi : S \rightarrow T$$

be a nonconstant holomorphic map. For every point $p \in S$ there exist a natural number $k \geq 1$ and local coordinates s around p and t around $\chi(p)$ such that χ is described by

$$s \mapsto t = s^k.$$

We call $\text{ord}_p(\chi) := k$ the *order of χ at p* and

$$v_p(\chi) := \text{ord}_p(\chi) - 1$$

the *branching order of χ at p* .

Obviously χ is biholomorphic in a neighborhood of p if and only if $v_p(\chi) = 0$. The point $p \in S$ is called a *branch point* if

$$v_p(\chi) \geq 1.$$

The image $M \subset T$ of all the branch points of χ in S is finite, and if we set

$$T' := T \setminus M, \quad S' := S \setminus \chi^{-1}(M),$$

then

$$\chi' := \chi|_{S'} : S' \rightarrow T'$$

is a covering map in the sense of Appendix 2. The number of sheets is well defined. We call it the *sheet number*, or *degree*, $\eta(\chi)$ of χ . Note that χ itself need not be a covering map. (The term sometimes used in this case is *branched covering*, but the terminology is highly nonuniform.) All this is easy to prove (see [Fo2], for instance). The proof of the next result takes considerably more effort.

Riemann-Hurwitz formula. *Let $\chi : S \rightarrow T$ be a nonconstant holomorphic map between compact Riemann surfaces. The numbers*

$$g(S) := \text{genus of } S,$$

$$g(T) := \text{genus of } T,$$

$$n(\chi) := \text{sheet number of } \chi,$$

$$v(\chi) := \sum_{p \in S} v_p(\chi) = \text{branching order of } \chi$$

are related by the equation

$$v(\chi) = 2(g(S) - 1) - 2n(\chi)(g(T) - 1).$$

In particular, for $T = \mathbb{P}_1(\mathbb{C})$,

$$g(S) = \frac{1}{2}v(\chi) - n(\chi) + 1.$$

Different proofs can be found in [Fo2] and [Ki].

9.7. The Riemann-Hurwitz formula can be used to compute the genus of an irreducible algebraic curve $C \subset \mathbb{P}_2(\mathbb{C})$. To do this, we use the maps

$$S \xrightarrow{\varphi} C \xrightarrow{\pi} \mathbb{P}_1(\mathbb{C}),$$

where φ is the resolution of singularities of Section 9.3 and π is a projection with center z off C . Then

$$\chi := \pi \circ \varphi : S \rightarrow \mathbb{P}_1(\mathbb{C})$$

is a branched covering with sheet number $n = \deg C$. It remains to compute the branching order v of χ . This is especially easy when C is smooth.

Lemma. *Let $C \subset \mathbb{P}_2(\mathbb{C})$ be a smooth, irreducible curve of degree n . Then its branching order satisfies*

$$v = n(n - 1)$$

if the center z of the projection π is chosen to be sufficiently general.

Setting $T = \mathbb{P}_1$ in the Riemann-Hurwitz formula gives an immediate corollary.

Genus formula. *A smooth, irreducible curve $C \subset \mathbb{P}_2(\mathbb{C})$ of degree n has genus*

$$g = \frac{1}{2}(n - 1)(n - 2).$$

Proof of the lemma. For a smooth curve we may assume that $S = C$, so what we have to determine is the branching order of the projection π . Let $z = (0 : 0 : 1)$ be the center of π . We assume that $z \notin C$. Then π is given by

$$C \rightarrow \mathbb{P}_1(\mathbb{C}), \quad p = (p_0 : p_1 : p_2) \mapsto q = (p_0 : p_1).$$

The geometry underlying the lemma is as follows: p is a branch point of π if and only if the line of projection $z \vee q$ is a tangent at p . If z does not lie on any bitangent or inflectional tangent, then there are exactly $n^* = n(n - 1)$ simple tangents from z to C (see Section 5.7). Being a simple tangent means $v_p(\pi) = 1$, and this gives the assertion.

Whoever finds this too short will have to put up with some computations. We write a minimal polynomial of C in the form

$$F = X_2^n + A_1 X_2^{n-1} + \cdots + A_n, \quad \text{where } A_i \in \mathbb{C}[X_0, X_1].$$

By Appendix 1.3, the discriminant $\Delta \in \mathbb{C}[X_0, X_1]$ has degree $n(n - 1)$. We choose coordinates such that

$$(0 : 1) \notin M := V(\Delta) \subset \mathbb{P}_1(\mathbb{C}).$$

If we set $C' := C \setminus \pi^{-1}(M)$, then the restriction

$$\pi' : C' \rightarrow \mathbb{P}_1(\mathbb{C}) \setminus M$$

is an unbranched covering. Thus we can look for all the branchings in the affine part

$$\mathbb{C} \times \mathbb{C} \rightarrow \mathbb{P}_2(\mathbb{C}), \quad (y_1, y_2) \mapsto (1 : y_1 : y_2).$$

If $f(Y_1, Y_2) = F(1, Y_1, Y_2)$ and $C_0 = V(f) \subset \mathbb{C} \times \mathbb{C}$, then

$$\pi_0 = \pi|_{C_0} : C_0 \rightarrow \mathbb{C} \quad \text{is given by} \quad (y_1, y_2) \mapsto y_1.$$

To simplify notation in describing the map π at $p \in C_0$, we suppose $p = (0, 0)$. Now we claim that

$$\text{ord}_p(\pi) = \text{ord } f(0, Y_2). \quad (*)$$

This follows from the Weierstrass preparation theorem (Section 6.7) and a Puiseux parametrization (Section 7.8): If $k := \text{ord } f(0, Y_2)$, then we can substitute an irreducible Weierstrass polynomial of degree k for f in a neighborhood of p (since C is smooth, it is locally irreducible), and we can parametrize C by

$$s \mapsto (s^k, \varphi(s)).$$

Composing this with π gives the map $t = s^k$, which proves $(*)$. The number k has yet another meaning:

$$k = \text{mult}_p(C \cap L_q),$$

where $L_q := z \vee q$ is the “ray of projection” through p . If the center z is chosen off the bitangents and inflectional tangents of C , then $k \leq 2$. Hence the exceptional set M consists of exactly $n(n-1)$ points, and over each one lies a branch point of order 1. \square

9.8. The method of Section 9.7 can also be applied to a singular curve, but then computing the branching order $v(\chi)$ is harder. We first treat the special case of a *Plücker curve* (see Section 5.7), and use the class formula

$$n^* = n(n-1) - 2d - 3s.$$

Choose coordinates so that the center of projection $z = (0 : 0 : 1)$ does not lie on any of the tangents to double points or cusps, and the tangents to smooth points $p_1, \dots, p_{n^*} \in C$ pass through z . We compute $v_x(\chi)$ for $x \in S$.

a) $\varphi(x) \notin \text{Sing } C \cup \{p_1, \dots, p_{n^*}\}$. Then $v_x(\chi) = 0$, as in Section 9.7.

b) $\varphi(x) \in \{p_1, \dots, p_{n^*}\}$. Again as in Section 9.7, $v_x(\chi) = 1$.

c) Let $\varphi(x)$ be a simple cusp. Since the ray of projection $L = z \vee \varphi(x)$ is not the cuspidal tangent, we get

$$\text{mult}_{\varphi(x)}(C \cap L) = 2, \quad \text{so} \quad v_x(\chi) = 1.$$

d) Let $\varphi(x)$ be a simple double point. Since the branch of C at $\varphi(x)$ corresponding to x cuts the ray of projection transversely, $v_x(\chi) = 0$. We get

$$v(\chi) = n^* + s = n(n-1) - 2(d+s).$$

Substituting this into the Riemann-Hurwitz formula gives

Clebsch's genus formula. *A Plücker curve of degree n in $\mathbb{P}_2(\mathbb{C})$ with $d + s$ singularities has genus*

$$g = \frac{1}{2}(n-1)(n-2) - (d+s).$$

Let $\varphi : S \rightarrow C$ be the desingularization of C . We used φ in Section 5.3 to construct a parametrization

$$\varphi^* : S \rightarrow C^*$$

of the same curve, and it is easy to see that φ^* is also a desingularization. Thus C and C^* have the same genus. With the notation of Section 5.7, we have another formula.

Dual genus formula. *A Plücker curve has genus*

$$g = \frac{1}{2}(n^* - 1)(n^* - 2) - (d^* + s^*).$$

Exercise. The genus of an irreducible curve $C \subset \mathbb{P}_2(\mathbb{C})$ of degree n satisfies the inequality

$$g \leq \frac{1}{2}(n-1)(n-2).$$

9.9. Clebsch's formula can be interpreted to mean that ordinary double points and cusps are to be subtracted with weight 1 in the computation of the genus of a curve. Higher weights may have to be used for more general singularities.

For a point $p \in C$, we defined the order

$$k_p := \text{ord}_p(C) \geq 1$$

in Section 3.3. p is singular if and only if $k_p \geq 2$; for simple double points or cusps, $k_p = 2$. In Appendix 5 we will describe a finer invariant $c_p \in \mathbb{N}$, with the following properties:

- 1) $c_p \geq k_p(k_p - 1)$,
- 2) c_p is an even number,
- 3) a) $c_p = 0 \iff p$ is smooth,
 b) $c_p = 2$ if p is a simple double point or a simple cusp.

This can be used to prove the following result (see Section A.5.4):

Max Noether's genus formula. *An irreducible algebraic curve $C \subset \mathbb{P}_2(\mathbb{C})$ of degree n has genus*

$$g = \frac{1}{2} \left((n-1)(n-2) - \sum_{p \in C} c_p \right).$$

For Plücker curves, this is Clebsch's formula.

Corollary. *If $\sum_{p \in C} k_p(k_p - 1) = (n-1)(n-2)$, then C is rational.*

We proved a simple special case of this in Proposition 3.3.

Theorem. Let A be a unique factorization domain. Let $f, g \in A[X]$ be as above, with $a_0 \neq 0$ and $b_0 \neq 0$. Then the following conditions are equivalent:

- i) f and g have a common factor of degree ≥ 1 in $A[X]$.
- ii) $R_{f,g} = 0$ in A .

Here the degree is always meant in terms of X , even when A itself is a ring of polynomials. We state the first step in the proof as a lemma.

Lemma. If A is an integral domain, then the following conditions are equivalent:

- i) There exist $\varphi, \psi \in A[X]$ with $(\varphi, \psi) \neq (0, 0)$, $\deg \varphi < \deg f$, $\deg \psi < \deg g$, and

$$\psi f + \varphi g = 0.$$

- ii) $R_{f,g} = 0$ in A .

Proof of the lemma. We may compute in the quotient field K of A because the coefficients of φ and ψ can be multiplied through by the common denominator. In the vector space V of polynomials of degree $< m + n$ in $K[X]$, we consider the elements

$$X^{n-1}f, \dots, Xf, f, X^{m-1}g, \dots, Xg, g. \quad (*)$$

The rows of the resultant matrix are the components of these vectors with respect to the basis $X^{m+n-1}, \dots, X, 1$ of V . Thus $R_{f,g} = 0$ means that the vectors $(*)$ are linearly dependent: there is a nontrivial relation

$$\begin{aligned} \mu_0 X^{n-1}f + \mu_1 X^{n-2}f + \dots + \mu_{n-1}f \\ + \lambda_0 X^{m-1}g + \lambda_1 X^{m-2}g + \dots + \lambda_{m-1}g = \psi f + \varphi g = 0. \quad \square \end{aligned}$$

For the *proof of the theorem*, we use the fact that A is a unique factorization domain. With this hypothesis, the following are equivalent:

- i) f and g have a common factor of degree ≥ 1 in $A[X]$.
- ii) There exist φ, ψ as above, with $\psi f + \varphi g = 0$.

(i) \Rightarrow (ii). If h is such a common factor, then $f = f_1 h$ and $g = g_1 h$, where $f, g \in A[X]$, and we can set $\varphi := f_1$, $\psi := -g_1$.

(ii) \Rightarrow (i). We decompose the polynomials in $f\psi = -g\varphi$ into prime factors

$$f_1 \cdots f_r \cdot \psi_1 \cdots \psi_k = -g_1 \cdots g_s \cdot \varphi_1 \cdots \varphi_l,$$

where factors of degree 0 in X may occur. Up to units, the g_1, \dots, g_s must also appear on the left-hand side. Since $\deg \psi < \deg g$, at least one g_σ with $\deg \geq 1$ is a prime factor of f . \square

Prime factors are linear over \mathbb{C} . This gives a corollary.

Corollary. For $f, g \in \mathbb{C}[X]$ with $\deg f, \deg g \geq 1$, the following are equivalent:

- i) f and g have a common zero.
- ii) $R_{f,g} = 0$.

A.1.2. An important special case of the resultant is the discriminant, which is obtained by letting g be the formal derivative of f . If

$$f = a_n X^n + \cdots + a_1 X + a_0, \quad f' := n a_n X^{n-1} + \cdots + a_1 \in A[X],$$

then $D_f := R_{f,f'} \in A$ is called the *discriminant* of f . It is the determinant of a $(2n-1) \times (2n-1)$ matrix. If $n \cdot a_n \neq 0$ in A , we can apply Theorem A.1.1 to obtain another result.

Corollary 1. Let A be a unique factorization domain with characteristic 0, and let $f \in A[X]$, with $\deg f \geq 1$. Then f has a repeated prime factor in $A[X]$ if and only if $D_f = 0$ in A .

Proof. By Theorem A.1.1, $D_f = 0$ is equivalent to

$$f = h \cdot \tilde{f} \quad \text{and} \quad f' = h \cdot g \quad \text{for some irreducible } h.$$

From $f' = h \tilde{f}' + h' \tilde{f} = h \cdot g$ and $\deg h' < \deg h$, it follows that h is a divisor of \tilde{f} . Hence h^2 is a divisor of f . The converse is trivial. \square

Corollary 2. For $f \in \mathbb{C}[X]$, the following are equivalent:

- i) f has a multiple zero in \mathbb{C} .
- ii) $D_f = 0$.

For low degrees n , the discriminant can be computed explicitly:

$$n = 1, f = a_0X + a_1, \quad D_f = a_0.$$

$$n = 2, f = a_0X^2 + a_1X + a_2, \quad D_f = a_0(4a_0a_2 - a_1^2).$$

$$n = 3, f = a_0X^3 + a_1X^2 + a_2X + a_3,$$

$$D_f = a_0(27a_0^2a_3^2 - 18a_0a_1a_2a_3 + 4a_0a_2^3 + 4a_1^3a_3 - a_1^2a_2^2),$$

or in “reduced form”

$$f = X^3 + a_2X + a_3, \quad D_f = 4a_2^3 + 27a_3^2.$$

It is easy to see that D_f is a homogeneous polynomial of degree $2n - 1$ in the coefficients of f .

A.1.3. In the proof of Bézout’s theorem (for instance), we need additional information about the resultant of homogeneous polynomials with respect to a distinguished variable.

Theorem. Let K be a field and $A = K[Y_1, \dots, Y_r]$. Let $f, g \in A[X]$,

$$f = a_0X^m + a_1X^{m-1} + \dots + a_m, \quad g = b_0X^n + b_1X^{n-1} + \dots + b_n,$$

where $a_0, b_0 \neq 0$, and a_μ and b_ν are homogeneous of degrees μ and ν , respectively. Then either $R_{f,g} \in A$ is homogeneous of degree $m \cdot n$ or $R_{f,g} = 0$.

Proof (following [Wa]). We use the familiar fact that a polynomial $a \in K[Y_1, \dots, Y_r]$ is homogeneous of degree d if and only if

$$a(TY_1, \dots, TY_r) = T^d a(Y_1, \dots, Y_r) \quad \text{in } K[Y_1, \dots, Y_r, T].$$

If we compute $R_{f,g}(TY_1, \dots, TY_r)$, then the entries of the resultant are multiplied by the following powers of T :

$$\begin{vmatrix} 0 & 1 & & & m & & & & \\ & 0 & & & & & m & & \\ & & & & & & & & \\ & & & 0 & & & & & m \\ 0 & & & & n & & & & \\ & 0 & & & & n & & & \\ & & & & & & & & \\ & & & & & & & & \\ & & & & 0 & & & & n \end{vmatrix}$$

Multiplying the rows by the indicated powers of T gives

$$\begin{array}{l} 1 : \\ 2 : \\ \vdots \\ n : \\ 1 : \\ 2 : \\ \vdots \\ \vdots \\ m : \end{array} \begin{vmatrix} 1 & 2 & & & m+1 & & & & \\ & 2 & & & m+1 & m+2 & & & \\ & & & & & & & & \\ & & & n & & & & & m+n \\ 1 & & & n & n+1 & & & & \\ 2 & & & 2 & & n+2 & & & \\ & & & \vdots & & & & & \\ & & & \vdots & & & & & \\ m & & & & m & 1+m & & & n+m \end{vmatrix}$$

But we can also obtain this by multiplying the i th column of $R_{f,g}$ by T^i . Thus, setting $p = (1 + \dots + n) + (1 + \dots + m)$ and $q = (1 + \dots + (m + n))$, we have

$$T^p R_{f,g}(TY) = T^q R_{f,g}(Y),$$

and the assertion follows because $q - p = m \cdot n$. □

A.1.4. The power of the resultant to detect common factors of polynomials without finding them explicitly, which seems so mysterious at first, becomes obvious once we manage to split a given polynomial into linear factors by extending its ring of coefficients. This is crucial in Chapter 8.

Theorem. Let A be an integral domain, and let

$$f = (X - c_1) \cdot \dots \cdot (X - c_m), \quad g = (X - d_1) \cdot \dots \cdot (X - d_n),$$

where $c_1, \dots, c_m, d_1, \dots, d_n \in A$. Then

$$R_{f,g} = \prod_{i=1}^m \prod_{j=1}^n (c_i - d_j) = g(c_1) \cdot \dots \cdot g(c_m).$$

In particular,

$$R_{g,f} = f(d_1) \cdot \dots \cdot f(d_n) = (-1)^{mn} R_{f,g}.$$

Corollary. For normalized polynomials $f_1, f_2, g \in A[X]$, we have

$$R_{f_1 \cdot f_2, g} = R_{f_1, g} \cdot R_{f_2, g} \quad \text{in } A.$$

Proof of the corollary. Apply the theorem in the common splitting field of f_1, f_2, g over the quotient field of A . \square

Proof of the theorem. Consider the polynomials

$$F := (X - Y_1) \cdot \dots \cdot (X - Y_m) = X^m + F_1 X^{m-1} + \dots + F_m,$$

$$G := (X - Z_1) \cdot \dots \cdot (X - Z_n) = X^n + G_1 X^{n-1} + \dots + G_n$$

in the ring $\mathbb{Z}[Y_1, \dots, Y_m, Z_1, \dots, Z_n, X]$. Here the F_μ are the elementary symmetric polynomials in Y_1, \dots, Y_m and are homogeneous of degree μ ; the G_ν are the elementary symmetric polynomials in Z_1, \dots, Z_n and are homogeneous of degree ν . We define

$$R := R_{F,G}, \quad S := \prod_{i,j} (Y_i - Z_j).$$

Both of these polynomials in $\mathbb{Z}[Y, Z]$ are homogeneous of degree $m \cdot n$ — S by definition, and R by Theorem A.1.3.

Now comes the trick that spares us a hard computation of derivatives. If we substitute Z_j for Y_i , then F and G have a common linear factor. Hence R has a zero at $Z_j = Y_i$, and the division algorithm for polynomials shows that $(Y_i - Z_j)$ is a divisor of R . We can do this for all i, j , so S is a divisor of R , and $R = aS$ for some $a \in \mathbb{Z}$. The diagonal of $R_{F,G}$ gives the term

$$(-1)^{m \cdot n} (Z_1 \cdot \dots \cdot Z_n)^m.$$

But this is also contained in S , so $a = 1$. The assertions follow by substituting $Y_i = c_i$ and $Z_j = d_j$. \square

Exercise. The discriminant of $f = (X - c_1) \cdot \dots \cdot (X - c_m)$ is

$$D_f = \prod_{i \neq j} (c_i - c_j).$$

Covering Maps

A.2.1. The maps we will briefly describe here were encountered in complex function theory in the nineteenth century. They later became a topic in topology (see [M], for instance). For our applications, it suffices to study topological spaces that are *locally path-connected* and *Hausdorff*. These properties will always be assumed in what follows. With these assumptions, the notions of connectedness and path-connectedness coincide.

Definition. Let $\varphi : S \rightarrow T$ be a continuous map.

a) φ is called a *local homeomorphism* if for every point $p \in S$ there exist neighborhoods U of p and V of $\varphi(p)$ such that

$$\varphi|U : U \rightarrow V \quad \text{is a homeomorphism.}$$

b) φ is called a *covering map*, or simply a *covering*, if for every point $q \in T$ there exists an open neighborhood V with the following property: if $\varphi^{-1}(V) = \bigcup_{i \in I} U_i$ is the decomposition into connected components, then for every $i \in I$ the map

$$\varphi|U_i : U_i \rightarrow V \quad \text{is a homeomorphism.}$$

It follows, in particular, that every such V is connected, $\varphi^{-1}(q) \neq \emptyset$, and every point $p \in \varphi^{-1}(q)$ lies in exactly one U_i . The U_i can be imagined as *sheets* lying over V . We will see in Section A.2.3 that the number of sheets is independent of q when T is connected.

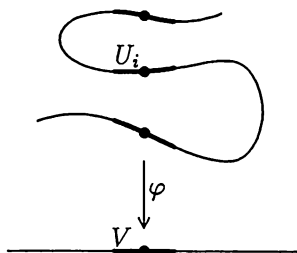

Figure A.2.1. Covering map

Every covering map is obviously a local homeomorphism, but the converse is not true. In complex function theory, covering maps in the sense defined above are sometimes also called *unbranched*.

Examples. a) $\iota : \mathbb{C}^* \rightarrow \mathbb{C}$, $z \mapsto z$, is a local homeomorphism but not a covering map.

b) $\mathbb{C} \rightarrow \mathbb{C}^*$, $z \mapsto e^z$, is an infinite-sheeted covering map.

c) For $k \in \mathbb{N}$, $k \geq 1$,

$$\mathbb{C}^* \rightarrow \mathbb{C}^*, \quad z \mapsto z^k,$$

is a k -sheeted covering map.

Remark 1. In topology, one computes a *fundamental group*

$$\pi_1(\mathbb{C}^*) = \mathbb{Z}$$

and proves that, corresponding to the possible subgroups $k\mathbb{Z} \subset \mathbb{Z}$, $k \in \mathbb{N}$, the only coverings of \mathbb{C}^* for which S is connected are those given in (b) and (c). (See [M].) A similar result holds for punctured disks (with suitable radii) and the circle

$$S_1 = \{z \in \mathbb{C} : |z| = 1\}.$$

Up to now we have made no assumptions about the connectedness of S or T .

Remark 2. Let $\varphi : S \rightarrow T$ be a covering map, where T is connected, and let $S_0 \subset S$ be a connected component. Then

$$\varphi|_{S_0} : S_0 \rightarrow T$$

is a covering map.

Proof. For $q \in T$, let V and $\varphi^{-1}(V) = \bigcup_{i \in I} U_i$ be as in the definition; let $p_i \in U_i$, where $\varphi(p_i) = q$. Let

$$I_0 := \{i \in I : p_i \in S_0\} \quad \text{and} \quad I_1 = I \setminus I_0.$$

By the properties of a connected component,

$$U_i \subset S_0 \quad \text{for } i \in I_0 \quad \text{and} \quad U_i \cap S_0 = \emptyset \quad \text{for } i \in I_1.$$

The assertion follows immediately. \square

A.2.2. It is often easy to check whether a map is a local homeomorphism. Sometimes one can conclude from this that it is a covering.

Lemma. *A proper map $\varphi : S \rightarrow T$ that is a local homeomorphism is a covering.*

Proof. The hypothesis of being *proper* means that if $K \subset T$ is compact, then $\varphi^{-1}(K) \subset S$ is also compact. In particular, this is true if S is compact. A proper map is, in particular, closed.

Let $q \in T$ and $p \in \varphi^{-1}(q)$. There exists a neighborhood U in which φ is a homeomorphism. Hence $\varphi^{-1}(q)$ is discrete and also compact, so

$$\varphi^{-1}(q) = \{p_1, \dots, p_n\}.$$

Let U_j and V_j be neighborhoods of p_j and q such that

$$\varphi|_{U_j} : U_j \rightarrow V_j$$

is a homeomorphism and $U := U_1 \cup \dots \cup U_n$. Since $S \setminus U$ is closed, so is $\varphi(S \setminus U) \subset T$. Hence

$$V := T \setminus \varphi(S \setminus U)$$

is an open neighborhood of q , which we may assume to be connected (perhaps after shrinking), and $\varphi^{-1}(V) \subset U$. Thus V has the desired properties. \square

A.2.3. The most important property of a covering map is that paths or, more generally, homotopies, can be lifted from T to S .

Lifting theorem. Let $\alpha : I = [0, 1] \rightarrow T$ be a path, with $q_0 := \alpha(0)$ and $q_1 := \alpha(1)$, and let $\varphi : S \rightarrow T$ be a covering map. For any $p_0 \in \varphi^{-1}(q_0)$, there is exactly one path $\tilde{\alpha} : I \rightarrow S$ such that

$$\begin{array}{ccc} & & S \\ & \nearrow \tilde{\alpha} & \downarrow \varphi \\ I & \xrightarrow{\alpha} & T \end{array}$$

commutes and $\tilde{\alpha}(0) = p_0$. In particular, the endpoint $p_1 := \tilde{\alpha}(1) \in \varphi^{-1}(q_1)$ is uniquely determined.

Proofs can be found in [Fo2], [M] (for instance).

Corollary. Let $\alpha : I \rightarrow T$ be a path from $q_0 = \alpha(0)$ to $q_1 = \alpha(1)$, and let $\varphi : S \rightarrow T$ be a covering map. Then the map

$$\varphi^{-1}(q_0) \rightarrow \varphi^{-1}(q_1), \quad p_0 \mapsto p_1 = \tilde{\alpha}(1),$$

is bijective. In particular, all the fibers $\varphi^{-1}(q)$ have the same number of points if T is connected. The number of points in a fiber is called the *sheet number*, or *degree*, of φ .

For a closed path based at $q \in T$, we obtain a permutation of $\varphi^{-1}(q)$.

Since homotopic paths based at q give the same permutation, we obtain an action of $\pi_1(T, q)$ on $\varphi^{-1}(q)$. It is transitive if S is connected.

The simple *proofs* are left to the reader (see also [M]).

The Implicit Function Theorem

In Section 6.9 we saw that the Weierstrass preparation theorem is a generalization of the implicit function theorem. Nevertheless a direct proof of this special case is useful: it is much shorter and, in addition, gives a method for the recursive construction of a solution. This is an improvement over Section 6.8.

Implicit function theorem. *Assume that the convergent power series $f \in \mathbb{C}\langle X_1, \dots, X_n, Y \rangle$ has the properties*

$$f(0, 0) = 0 \quad \text{and} \quad \frac{\partial f}{\partial Y}(0, 0) \neq 0.$$

Then there is a unique series $\varphi \in \mathbb{C}\langle X_1, \dots, X_n \rangle$ such that

$$\varphi(0) = 0 \quad \text{and} \quad f(X_1, \dots, X_n, \varphi(X_1, \dots, X_n)) = 0.$$

Geometrically, the series f defines an analytic set around the origin $(0, 0) \in \mathbb{C}^n \times \mathbb{C}$. When $n = 1$ this is the germ of a curve, and the condition on the derivative means that this curve is smooth and has a nonvertical tangent at the origin. This excludes the cases in Figure A.3.1.

The existence of φ means that the analytic set is the graph of a holomorphic function sufficiently close to $0 \in \mathbb{C}^n$; see Figure A.3.2.

Proof [Wal]. In order to be able to apply the Banach fixed-point theorem, we have to construct a contracting operator. For this purpose

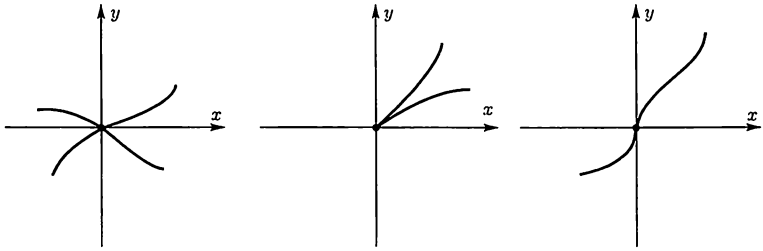

Figure A.3.1

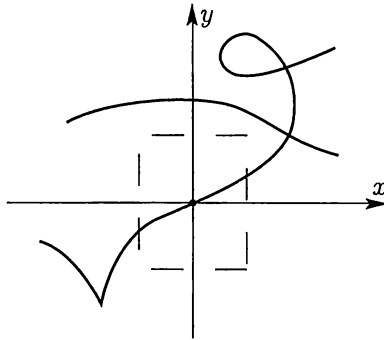

Figure A.3.2

we replace

$$f(X, Y) = \sum a_{\nu\mu} X^\nu Y^\mu$$

by

$$g(X, Y) := Y - \frac{f(X, Y)}{a_{01}} = \sum b_{\nu\mu} X^\nu Y^\mu,$$

where $X = (X_1, \dots, X_n)$ and $\nu = (\nu_1, \dots, \nu_n)$ is a multi-index (Section 6.2). Then, by definition,

$$a_{01} \neq 0, b_{00} = b_{01} = 0 \quad \text{and} \quad b_{\nu\mu} = -\frac{a_{\nu\mu}}{a_{01}} \quad \text{otherwise.}$$

We consider the maximal ideal $\mathfrak{m} \subset \mathbb{C}[[X_1, \dots, X_n]]$ and the operator

$$G : \mathfrak{m} \longrightarrow \mathfrak{m}, \quad \varphi(X) \longmapsto g(X, \varphi(X)),$$

defined by the substitution $Y = \varphi(X)$. By definition of g we have

$$f(X, \varphi(X)) = 0 \iff g(X, \varphi(X)) = \varphi(X)$$

for every $\varphi \in \mathfrak{m}$. Hence we look for a convergent fixed “point” of G . The problem is to find a closed set in a Banach algebra, where G is a contraction. We use the Banach algebras defined in Section 6.4.

Lemma. *Assume that f is convergent for $X = (r_1, \dots, r_n)$ and $Y = s$, where $0 < r_i, s \in \mathbb{R}$. Then we can find $\varrho = (\varrho_1, \dots, \varrho_n)$ and σ such that $0 < \varrho_i < r_i$ and $0 < \sigma < s$ with the following property: If*

$$D := \{u \in B_\varrho \cap \mathfrak{m} : \|u\|_\varrho \leq \sigma\},$$

then $G(D) \subset D$, and G is a contraction on D .

Obviously D is closed in B_ϱ , so the fixed-point theorem implies the existence of a unique $\varphi \in D$ with $G(\varphi) = \varphi$. This is the desired solution. \square

Proof of the lemma. For any $\varrho < r$ and $\sigma < s$ we define

$$A := \sum_{\nu} |b_{\nu 0}| \varrho^{\nu}, \quad B := \sum \mu \cdot |b_{\nu \mu}| \varrho^{\nu} \sigma^{\mu-1}.$$

These real numbers depend continuously on ϱ and σ , and vanish at the origin. So we can first choose positive ϱ and σ such that $B \leq \frac{1}{2}$ and then shrink ϱ by keeping σ fixed until $A \leq \frac{1}{2}\sigma$. Now, if $u, v \in D$ and $\mu \in \mathbb{N}$, then

$$\begin{aligned} \|u^\mu - v^\mu\|_\varrho &\leq \|u - v\|_\varrho \cdot \|u^{\mu-1} + u^{\mu-2}v + \dots + v^{\mu-1}\|_\varrho \\ &\leq \|u - v\|_\varrho \cdot (\|u\|_\varrho^{\mu-1} + \|u\|_\varrho^{\mu-2}\|v\|_\varrho + \dots + \|v\|_\varrho^{\mu-1}) \\ &\leq \mu \cdot \|u - v\|_\varrho \sigma^{\mu-1}. \end{aligned}$$

Hence

$$\begin{aligned} \|Gu - Gv\|_\varrho &\leq \sum \|b_{\nu \mu} X^\nu (u^\mu - v^\mu)\|_\varrho \\ &\leq \sum |b_{\nu \mu}| \cdot \|X\|_\varrho^\nu \cdot \|u^\mu - v^\mu\|_\varrho \\ &\leq \sum \mu |b_{\nu \mu}| \varrho^\nu \sigma^{\mu-1} \cdot \|u - v\|_\varrho \\ &= B \|u - v\|_\varrho \leq \frac{1}{2} \|u - v\|_\varrho. \end{aligned}$$

This proves that G is a contraction on $B_\rho \cap \mathfrak{m}$. If $u \in D$, then

$$\begin{aligned} \|Gu\|_\rho &\leq \|G(0)\|_\rho + \|Gu - G(0)\|_\rho \\ &\leq \|G(0)\|_\rho + \frac{1}{2}\sigma \leq A + \frac{1}{2}\sigma \leq \sigma. \end{aligned}$$

Hence $Gu \in D$. □

Once the existence of the solution as the fixed point of an operator is clear, it is easy to give a step-by-step construction of the power series. By the fixed-point theorem the iterated images of an arbitrary starting point converge to a fixed point. With the notation above we have the following

Corollary. *Define $\varphi_0 := 0$ and $\varphi_{k+1} := G\varphi_k$. Then the sequence $(\varphi_k)_k$ converges formally to the solution φ . More precisely,*

$$\varphi - \varphi_k \in \mathfrak{m}^{k+1}.$$

Proof. We proceed by induction on k . The case $k = 0$ is clear, since $\varphi \in \mathfrak{m}$. Now

$$\begin{aligned} \varphi - \varphi_{k+1} &= \varphi - G\varphi_k = \varphi - g(X, \varphi_k(X)) \\ &= g(X, \varphi(X)) - g(X, \varphi_k(X)) \\ &= \sum b_{\nu\mu} X^\nu (\varphi^\mu(X) - \varphi_k^\mu(X)) \\ &= b_{\nu\mu} X^\nu (\varphi - \varphi_k) (\varphi^{\mu-1} + \varphi^{\mu-2}\varphi_k + \cdots + \varphi_k^{\mu-1}). \end{aligned}$$

For $|\nu| \geq 1$ we have $X^\nu \in \mathfrak{m}$. On the other hand,

$$\varphi^{\mu-1} + \varphi^{\mu-2}\varphi_k + \cdots + \varphi_k^{\mu-1} \in \mathfrak{m}^{\mu-1}.$$

So if $|\nu| = 0$ we use $b_{00} = b_{01} = 0$. Hence we are left with the case $|\nu| \geq 2$ and the factor above is in \mathfrak{m} . In any case,

$$\varphi - \varphi_{k+1} \in \mathfrak{m}^{k+2}. \quad \square$$

The Newton Polygon

A.4.1. In the construction of the Puiseux series in Chapter 7, we used the *carrier* of a power series in two variables

$$\text{carr} \left(\sum a_{\mu\nu} X^\mu Y^\nu \right) = \{(\mu, \nu) \in \mathbb{N}^2 : a_{\mu\nu} \neq 0\}$$

as just a set of lattice points in the plane. Now we will supplement this with a nice connection between the geometry of this set and the factorization of the series. We follow the presentation of B. Teissier, which can be found in [Che].

To define the Newton polygon of $f \in \mathbb{C}[[X, Y]]$, we consider the *lower convex hull* of $\text{carr}(f)$ in $\mathbb{R}_+ \times \mathbb{R}_+$. This hull is constructed by placing supporting lines with slope ≤ 0 from below (in the ordering of \mathbb{R}); its boundary contains a compact polygonal arc, which is called the *Newton polygon*.

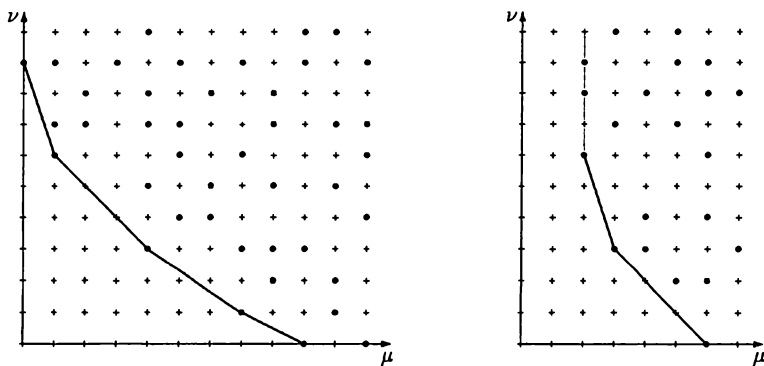

Figure A.4.1. Newton polygons

In general, the Newton polygon consists of finitely many segments with negative rational slopes. But it can also degenerate to a single point, for instance when f is a unit (i.e. $a_{00} \neq 0$).

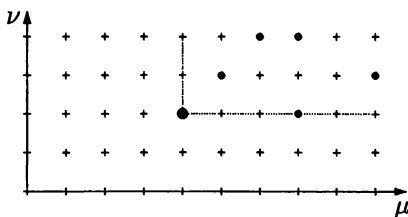

Figure A.4.2. A degenerate Newton polygon

Now we turn to the algebraic aspect. To do this, we consider the ring $\mathbb{C}[[X^*]]$ (introduced in Section 7.12), which contains the solutions to the Puiseux problem, namely series with fractional exponents and rational orders. Everything else is based on the easy-to-see connection between slope and order:

Proposition. *Let $f \in \mathbb{C}[[X, Y]]$ and $\varphi \in \mathbb{C}[[X^*]]$, with $\varrho := \text{ord } \varphi > 0$ and $f(X, \varphi) = 0$. Then the Newton polygon of f contains a segment with slope $-1/\varrho$.*

Thus the orders of all possible Puiseux parametrizations of f can be read off from the Newton polygon.

Proof. If $\varphi \in \mathbb{C}[[X^{\frac{1}{n}}]]$, we set $X = T^n$ to avoid fractional exponents. Thus

$$\varphi = \lambda T^m + \dots, \quad \text{where } \lambda \in \mathbb{C}^*, m = n\varrho.$$

$f(T^n, \varphi) = 0$ in $\mathbb{C}[[T]]$, and in particular the term of lowest order in this series must vanish. To determine it, we can substitute λT^m for φ . Then

$$f(T^n, \lambda T^m) = \sum_{\mu, \nu} a_{\mu\nu} \lambda^\nu T^{n\mu + m\nu} = T^l \sum_{n\mu + m\nu = l} a_{\mu\nu} \lambda^\nu + \dots,$$

where $l := \min\{n\mu + m\nu : (\mu, \nu) \in \text{carr}(f)\}$. Thus λ is a zero of the polynomial

$$g(\lambda) := \sum_{n\mu + m\nu = l} a_{\mu\nu} \lambda^\nu.$$

Since $\lambda \neq 0$, g must have at least two nonzero coefficients. So there must be at least two points in the carrier of f that have distinct ν and lie on the line $n\mu + m\nu = l$. By the minimality of l , this line contains a segment of the Newton polygon with slope $-n/m$. \square

The following is a simple geometric application. A convergent series $f \in \mathbb{C}\langle X, Y \rangle$ with $f(0) = 0$ determines the germ $V(f)$. A smooth branch of this germ of a curve, if one exists, can be parametrized by

$$X \mapsto (X, \varphi(X)) \quad \text{or} \quad Y \mapsto (\psi(Y), Y),$$

where φ and ψ are power series with integer exponents. Hence the Newton polygon of f must have a segment with slope $-1/m$ or $-n$, where $m, n \in \mathbb{N}$. If the tangent to the branch is not one of the coordinate axes, then the slope of the segment is -1 . Unfortunately, this condition on the Newton polygon is only necessary, as is shown by the example

$$f(X, Y) = X^3 - (X - Y)^2, \quad Y = \varphi(X) = X + X^{\frac{3}{2}}$$

of a linearly transformed cuspidal cubic (but see Corollary 3 in Section A.4.2). As an exercise, consider the Newton polygons of the three- and four-leaf clovers of Section 3.3.

In Section 7.6 we used the quasi-homogeneous initial polynomial to construct the Puiseux series. This corresponds to the steepest segment of the Newton polygon. We can now show that it is possible to start with an arbitrary segment of the Newton polygon. If the slope equals $-n/m$, the series has order m/n . The initial term is constructed as in the remark above; the iteration is even more complicated than in Section 7.6 (see [Bu] or [Che], for instance). If the series one starts with is a Weierstrass polynomial, the iteration is much simpler (see Corollary 2 in Section A.4.2).

A.4.2. The connection between geometric properties of the Newton polygon and algebraic properties of the power series is especially easy to see after one has applied the preparation theorem to the power series; that is, when it is assumed to be a Weierstrass polynomial.

Let $f \in \mathbb{C}\langle X \rangle[Y]$ be a Weierstrass polynomial of degree $k > 0$ that does not have Y as a divisor. We factor f as in the complement

in Section 7.12, and arrange the roots of f in $\mathbb{C}[[X^*]]$ according to their orders:

$$f = f_1 \cdots f_l, \quad f_j = (Y - \varphi_{j,1}) \cdots (Y - \varphi_{j,k_j}), \quad j = 1, \dots, l, \quad (*)$$

where

$$\varrho_j = \text{ord } \varphi_{j,i} \text{ for } i = 1, \dots, k_j, \quad \text{and} \quad \varrho_1 > \varrho_2 > \cdots > \varrho_l > 0.$$

Then $k = k_1 + \cdots + k_l$. If g is an irreducible factor of f , then g divides exactly one f_j because all the roots of g have the same order by Corollary 7.10. Thus the factorization $(*)$ of f is cruder in general than the factorization into irreducible factors. Unfortunately not equal, but still comparable. And the characteristic numbers k_j and ϱ_j can be read off with the naked eye from the Newton polygon:

Theorem. *Let $f \in \mathbb{C}\langle X \rangle[Y]$ be a Weierstrass polynomial that is factored as in $(*)$ and not divisible by Y . Then the Newton polygon of f consists of segments S_1, \dots, S_l ; for $j = 1, \dots, l$, the slopes of these segments are $-1/\varrho_j$ and the heights (i.e. the projections on the vertical ν -direction) are k_j .*

Corollary 1. *The Newton polygon of an irreducible Weierstrass polynomial consists of a single segment.*

Hence reducibility—but unfortunately not irreducibility!—can often be seen immediately. (Example: $f = X^2 - Y^2$.)

Corollary 2. *Let $f \in \mathbb{C}\langle X \rangle[Y]$ be a Weierstrass polynomial, and $-1/\varrho$ the slope of a segment of its Newton polygon. Then there exists a convergent $\varphi \in \mathbb{C}[[X^*]]$ such that $f(X, \varphi(X)) = 0$ and $\text{ord } \varphi = \varrho$.*

Proof. All possible solutions φ of the Puiseux problem appear in the decomposition $(*)$. □

Corollary 3. *If the Newton polygon of a Weierstrass polynomial has a segment of height 1, then the germ $V(f)$ has a smooth branch.*

Proof. This segment corresponds to an irreducible factor of f in $\mathbb{C}\langle X \rangle[Y]$ that is linear in Y . □

More generally, the heights k_1, \dots, k_l permit an estimate of the degrees of the irreducible factors of f . This can be used to advantage in the theory of singularities; an explanation is given in [B-K].

For the *proof of the theorem*, we construct the carrier of f recursively from linear factors of the form $Y - \varphi$, where $\varphi \in \mathbb{C}[[X^*]]$. As intermediate steps, series in $\mathbb{C}[[X^*]][Y]$ appear whose *carriers* (more generally than in Section 7.3) are subsets of $\mathbb{Q} \times \mathbb{N}$.

The most elementary step is the following. If $\text{ord } \varphi = \varrho \in \mathbb{Q}$ and $g = X^\sigma Y^n$, where $(\sigma, n) \in \mathbb{Q} \times \mathbb{N}$, then the carriers of $(Y - \varphi)$, g , and $(Y - \varphi) \cdot g$ look like this:

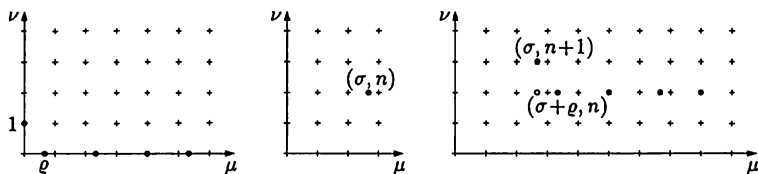

Figure A.4.3. The carriers of $(Y - \varphi)$, g , and $(Y - \varphi) \cdot g$

In particular, the Newton polygon of $Y - \varphi$ consists of a single segment. Now let $g \in \mathbb{C}[[X^*]][Y]$ be general in Y of order k' . Suppose S' is the steepest segment of the Newton polygon of g , and let its slope be $-1/\varrho'$. We examine the Newton polygon of $(Y - \varphi) \cdot g$ if $0 < \text{ord } \varphi = \varrho \leq \varrho'$.

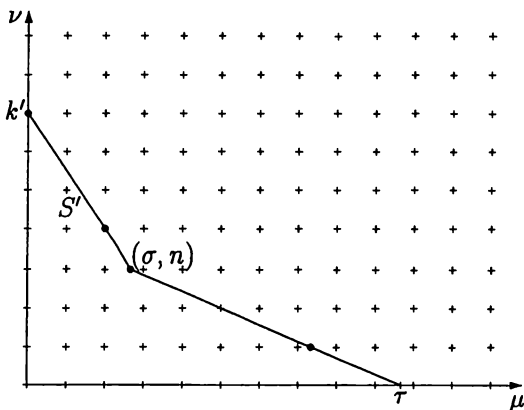

Figure A.4.4. Newton polygon of g

To determine the Newton polygon we can replace φ by the initial term λX^e , where $\lambda \neq 0$. It is easy to see from the pictures that the Newton polygon of g is shifted e units to the right.

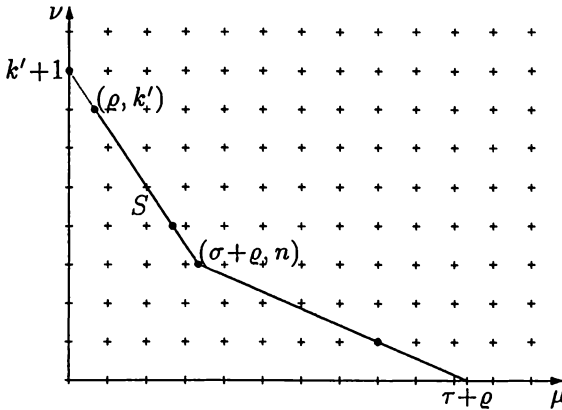

Figure A.4.5. Newton polygon of $(Y - \varphi) \cdot g$ in the case $e = e'$

When $e = e'$, the upper left-hand segment S' is stretched as shown; when $e < e'$, a steeper segment S'' is added.

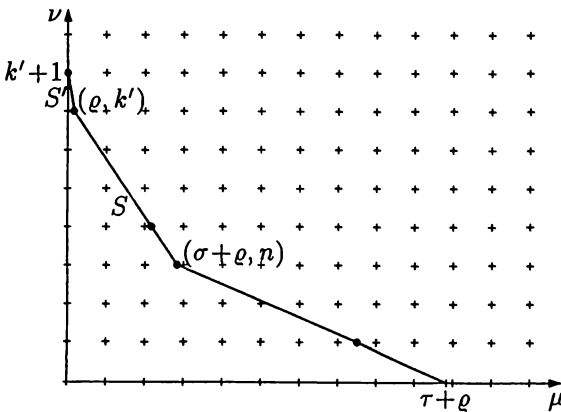

Figure A.4.6. Newton polygon of $(Y - \varphi) \cdot g$ in the case $e < e'$

Thus the recursion is clear: we have the orders

$$\varrho_1 > \varrho_2 > \cdots > \varrho_l > 0,$$

and construct f in the corresponding order from the linear factors. This determines the form of the Newton polygon. \square

A Numerical Invariant of Singularities of Curves

A.5.1. Two germs of curves at the origin in \mathbb{C}^2 (see Section 6.12) are called *analytically equivalent* if one can be mapped to the other by a map that is biholomorphic in a neighborhood of the origin. For two curves C and C' , this also defines analytic equivalence at points $p \in C$ and $p' \in C'$. If p and p' are smooth points, then they are always equivalent in this sense; otherwise we speak of *analytically equivalent singularities*.

Proving that two singularities are equivalent, or even classifying all possible singularities up to equivalence, is a very hard problem. It may be easier to show non-equivalence by using suitable *analytic invariants*. The simplest invariants are natural numbers, such as the order (introduced in Section 3.3) or the number of local branches (Section 6.14). In contrast, note that the degree of the whole curve is a global invariant but not a local invariant at a point.

Among the many numerical invariants of singularities is one that is particularly useful because it can be used to measure the effect of the singularity on the class and genus of the curve—that is, to generalize the formulas of Plücker and Clebsch. We describe it in this appendix. Our presentation is based primarily on [Na] and [Ki].

A.5.2. We consider the following situation. Let $C = V(f)$ be a germ of a curve at the origin 0 of \mathbb{C}^2 , where $f \in \mathbb{C}\langle X, Y \rangle$ is minimal. Let the decomposition into branches be

$$C = C_1 \cup \cdots \cup C_s.$$

Further, let $L \subset \mathbb{C}^2$ be a line through 0 , parametrized by

$$T \mapsto (aT, bT), \quad (a : b) \in \mathbb{P}_1(\mathbb{C}).$$

Its point at infinity in $\mathbb{P}_2(\mathbb{C})$ is

$$q = (0 : a : b) \in \bar{L}.$$

For the germ C and this point q , we can define

$$P_q C := V\left(a \frac{\partial f}{\partial X} + b \frac{\partial f}{\partial Y}\right)$$

to be the *germ of a polar*, just as we did for algebraic curves. As in Section 4.2, we see that it has no branch in common with C if L is not a branch of C . The following statement about the intersection multiplicities of germs at the origin is crucial for the definition of the desired invariant.

Lemma. *Suppose that the branch C_i of C is not a line, and q is a point at infinity of the line L through 0 . Then the integer*

$$\text{mult}(C_i, P_q C) - \text{mult}(C_i, L)$$

is independent of the choice of the line L . In particular, $\text{mult}(C_i, P_q C)$ is independent of q if q is not on the tangent to C_i .

Proof. First we consider the two lines

$$V(X) \quad \text{and} \quad V(Y)$$

and the polars

$$V\left(\frac{\partial f}{\partial Y}\right) \quad \text{and} \quad V\left(\frac{\partial f}{\partial X}\right).$$

If the branch C_i has a Puiseux parametrization

$$T \mapsto (\varphi(T), \psi(T)),$$

then, by 8.3 (5),

$$\text{mult}(C_i, V(X)) = \text{ord}_T \varphi \quad \text{and} \quad \text{mult}(C_i, V(Y)) = \text{ord}_T \psi.$$

Moreover, by Section 8.4,

$$\text{mult} \left(C_i, V \left(\frac{\partial f}{\partial Y} \right) \right) = \text{ord}_T \frac{\partial f}{\partial Y}(\varphi(T), \psi(T)),$$

$$\text{mult} \left(C_i, V \left(\frac{\partial f}{\partial X} \right) \right) = \text{ord}_T \frac{\partial f}{\partial X}(\varphi(T), \psi(T)).$$

Differentiating $f(\varphi(T), \psi(T)) = 0$ with respect to T gives

$$\frac{\partial f}{\partial X}(\varphi, \psi) \cdot \frac{d\varphi}{dT} + \frac{\partial f}{\partial Y}(\varphi, \psi) \cdot \frac{d\psi}{dT} = 0.$$

Hence

$$\text{ord}_T \frac{\partial f}{\partial X} + \text{ord}_T \varphi = \text{ord}_T \frac{\partial f}{\partial Y} + \text{ord}_T \psi. \quad (*)$$

Now we can assume that $V(Y)$ is the tangent to C_i . By Section 8.1,

$$k := \text{ord}_T \varphi < \text{ord}_T \psi =: r. \quad (**)$$

Comparing a point $q = (0 : a : 1)$ and the line L with the point $p = (0 : 1 : 0)$ and the line $V(Y)$, we have

$$k = \text{mult}(C_i, L), \quad r = \text{mult}(C_i, V(Y)).$$

It follows from (*) and (**) that

$$\text{ord}_T \frac{\partial f}{\partial Y} < \text{ord}_T \frac{\partial f}{\partial X} \quad \text{so} \quad \text{ord}_T \left(a \frac{\partial f}{\partial X} + \frac{\partial f}{\partial Y} \right) = \text{ord}_T \frac{\partial f}{\partial Y}.$$

Using (*) again gives

$$\text{mult}(C_i, P_q C) - \text{mult}(C_i, L) = \text{mult}(C_i, P_p C) - \text{mult}(C_i, V(Y)). \quad \square$$

Definition. As above, let $C = C_1 \cup \dots \cup C_s$ be a germ of a curve, decomposed into branches, and let L be a line through 0 with point at infinity q . For $i = 1, \dots, s$, let

$$c_i := \text{mult}(C_i, P_q C) - \text{mult}(C_i, L) + 1,$$

$$c := c_1 + \dots + c_s.$$

Examples. a) If C is smooth, then $s = 1$ and $c = 0$.

b) For a simple double point, $s = 2$; if L is not tangent to either branch, then

$$\text{mult}(C_i, P_q C) = 1, \quad \text{mult}(C_i, L) = 1, \quad \text{so} \quad c_i = 1 \text{ and } c = 2.$$

c) For a simple cusp, $s = 2$; if L is not the cuspidal tangent, then

$$\text{mult}(C, P_q C) = 3, \quad \text{mult}(C, L) = 2, \quad \text{so } c = 2.$$

The following theorem gives the simplest properties of this number c for a germ of a curve.

Theorem. *Let $C = C_1 \cup \dots \cup C_s$ be a germ of a curve at 0, decomposed into branches, and let $c = c_1 + \dots + c_s$ be defined as above. Then c has the following properties:*

1) c is invariant under linear changes of coordinates.

2) If L is not tangent to any branch of C , then

$$c = \text{mult}(C, P_q C) - \text{ord } C + s.$$

3) $c \geq 0$.

4) $c = 0$ if and only if C is smooth at 0.

Proof. (1) follows from the invariance of intersection numbers under these changes of coordinates; (2) follows from the additivity of intersection numbers and orders.

The rest of the proof is a triviality for Weierstrass and Puiseux. We choose coordinates so that no branch has a vertical tangent. Then C is described by a Weierstrass polynomial

$$f(X, Y) = Y^k + a_1(X)Y^{k-1} + \dots + a_k(X),$$

and considering the homogeneous initial form of f shows that

$$\text{ord } a_j \geq j \quad \text{for } j = 1, \dots, k.$$

If this series is minimal in the sense of Section 6.14, then

$$f = f_1 \cdot \dots \cdot f_s,$$

where the f_i are distinct Weierstrass polynomials of degree $k_i = \text{ord } C_i$ and

$$k = k_1 + \dots + k_s.$$

For each branch $C_i = V(f_i)$ there is a Puiseux parametrisation

$$T \mapsto (T^{k_i}, \varphi_i(T)), \quad \text{where } \text{ord}_T \varphi_i \geq k_i.$$

(See Section 8.1.) We have

$$\frac{\partial f}{\partial Y} = kY^{k-1} + (k-1)a_1(X)Y^{k-2} + \cdots + a_{k-1}(X).$$

Substituting and considering the orders, we see that

$$\text{ord}_T \frac{\partial f}{\partial Y}(T^{k_i}, \varphi_i(T)) \geq k_i(k-1).$$

Thus $c_i \geq k_i(k-2) + 1$ and $c \geq k(k-2) + s$. (3) and (4) follow. \square

Exercise. Give the singularities when $c = 2$.

We prove a better estimate for c in Section A.5.5. The following result is much more difficult.

Gorenstein-Rosenlicht theorem. *Let $C = V(f)$ be a germ of a curve, where $f \in \mathbb{C}\langle X, Y \rangle$ is minimal, and let \tilde{R} be the integral closure of the ring*

$$R = \mathbb{C}\langle X, Y \rangle / (f).$$

Then $c = 2 \dim_{\mathbb{C}}(\tilde{R}/R)$.

In particular, c is an even number and an analytic invariant.

For the *proof*, see [Go] and [Ko2]. Because of this theorem, the invariant

$$\delta := \frac{1}{2}c$$

is usually used instead of c ; this is sometimes called the *degree of the singularity*. It can be described differently through so-called monoidal transformations, with which the singularities of a germ of a curve can be resolved. Resolving singularities in this way produces a “tree,” which is planted at p and terminates in smooth points q_1, \dots, q_s (where $s =$ the number of branches). Altogether, it contains points p_1, \dots, p_t (including p and q_1, \dots, q_s). These are called infinitely near points, and they have orders k_1, \dots, k_t , where $\text{ord } q_i = 1$. Then

$$c = \sum_{j=1}^t k_j(k_j - 1).$$

A proof of this equality, which also clarifies the Gorenstein-Rosenlicht theorem, can be found in [Ha], Example V.3.9.3.

Much historical information about the invariant δ can be found in [A2]; a description via the semigroup of a singularity is given in [Ku].

A.5.3. If $C \subset \mathbb{P}_2(\mathbb{C})$ is again a globally defined algebraic curve, then for every point $p \in C$ we can consider the germ and also the invariant $c_p \in \mathbb{N}$, as in Section A.5.2. Since c_p was defined by means of a polar, it is hardly surprising that we can use it to generalize Plücker's class formula.

General class formula. Let $C \subset \mathbb{P}_2(\mathbb{C})$ be irreducible of degree $n \geq 2$. Let

$$\begin{aligned} n^* &= \text{class of } C, \\ k_p &= \text{order of } C \text{ at } p, \\ s_p &= \text{number of branches of } C \text{ at } p. \end{aligned}$$

Then

$$n^* = n(n-1) - \sum_{p \in \text{Sing } C} (c_p + k_p - s_p).$$

Proof. We use the technique of Section 5.9 again. In addition, we choose coordinates in $\mathbb{P}_2(\mathbb{C})$ so that through $q = (0 : 0 : 1)$ there pass exactly n^* tangents through smooth points of C , and no tangent to a singular point passes through q . By Bézout's theorem,

$$n(n-1) = n^* + \sum_{p \in \text{Sing } C} \text{mult}_p(C \cap P_q C).$$

By Section A.5.2 it follows that

$$\text{mult}_p(C \cap P_q C) = c_p + k_p - s_p. \quad \square$$

We should not neglect to mention that

$$c_p + k_p - s_p = \begin{cases} 2 + 2 - 2 = 2 & \text{if } p \text{ is a simple double point,} \\ 2 + 2 - 1 = 3 & \text{if } p \text{ is a simple cusp.} \end{cases}$$

A.5.4. The proof of Clebsch's genus formula for Plücker curves in Section 9.8 used Plücker's class formula. With the general class formula and the invariant c_p , the method of projection to $\mathbb{P}_2(\mathbb{C})$ gives the following formula, which was announced in Section 9.9:

$$g = \frac{1}{2} \left((n-1)(n-2) - \sum_{p \in \text{Sing } C} c_p \right).$$

For the *proof*, we proceed as in Section 9.7 and use the maps

$$\begin{array}{ccc} S & \xrightarrow{\varphi} & C \subset \mathbb{P}_2(\mathbb{C}) \\ & \searrow \chi & \downarrow \pi \\ & & \mathbb{P}_1(\mathbb{C}), \end{array}$$

where φ is a resolution of singularities and π is the projection with center $(0 : 0 : 1)$. Under the hypotheses of Section 9.7, the branching order of χ is

$$v(\chi) = n^* + \sum_{p \in \text{Sing } C} (k_p - s_p). \quad (*)$$

We need only prove this formula. For then, using the class formula A.5.3, we have

$$v(\chi) = n(n-1) - \sum_{p \in \text{Sing } C} c_p,$$

and the formula above for g follows from the Riemann-Hurwitz theorem (Section 9.6).

To prove $(*)$ we compute the contribution of the singularities to the branching order. If $p \in \text{Sing } C$, then

$$\varphi^{-1}(p) = \{x_1, \dots, x_{s_p}\},$$

and to every x_i there corresponds a branch C_i of the germ of C at p . We can change coordinates so that $p = (1 : 0 : 0)$. Since φ is constructed by means of Puiseux parametrizations, we can choose a coordinate t around x_i so that the parametrization of C_i is described by

$$t \mapsto (t^{k_i}, \varphi_i(t)), \quad \text{where } k_i = \text{ord } C_i.$$

Thus χ is described around x_i by

$$t \mapsto t^{k_i}, \quad \text{so} \quad v_{x_i}(\chi) = k_i - 1.$$

The total contribution of p to the branching order is

$$\sum_{i=1}^{s_p} (k_i - 1) = k_p - s_p. \quad \square$$

The inflection point formula, like the class formula, can be generalized to curves with arbitrary singularities. The interested reader may consult [B-K].

A.5.5. The estimate for the invariant c proved in Section A.5.3 is very weak. In particular, it gives no information about how c behaves with respect to the simplest local invariant, the order. We will work this out now.

Theorem. *If C is a germ of a curve with order k , then $c \geq k(k-1)$.*

Proof (see [Na]). As in the proof of Theorem A.5.2, we use the minimal Weierstrass polynomial

$$f = f_1 \cdots f_s \quad \text{of degree } k = k_1 + \cdots + k_s.$$

For each $i \in \{1, \dots, s\}$, it suffices to show that

$$c_i \geq k_i(k-1). \quad (*)$$

The assertion will follow by adding these inequalities.

To prove (*) we choose coordinates (X, Y) so that the tangent to the branch C_i is horizontal (i.e. the tangent is $V(Y)$), and no branch has a vertical tangent. By Section A.5.2,

$$c_i = \text{mult}(C_i, P_q C) - k_i + 1,$$

where $q := (0 : 0 : 1)$ and $L = V(X)$. Thus it suffices to prove that

$$\text{mult}(C_i, P_q C) \geq k_i k - 1. \quad (**)$$

By Puiseux, the branch C_i is parametrized by

$$T \mapsto (T^{k_i}, \varphi(T)), \quad \text{where} \quad \text{ord}_T \varphi \geq k_i + 1.$$

(See Section 8.1.) Now we consider the Newton polygon of f (see Section A.4.2). Its vertices are contained in

$$\{(\mu, \nu) \in \mathbb{N}^2 : \mu + \nu \geq k\}$$

because no branch of C has a vertical tangent. Hence the coefficients $a_j(X)$ of f satisfy

$$\text{ord}_X a_j \geq j \quad \text{for } j = 1, \dots, k.$$

Since $\text{ord}_T \varphi \geq k_i + 1$, the Newton polygon contains a segment of height k_i and slope ϱ , where $-1 < \varrho < 0$. Thus we even have

$$\text{ord}_X a_j \geq j + 1 \quad \text{for } k - k_i < j \leq k.$$

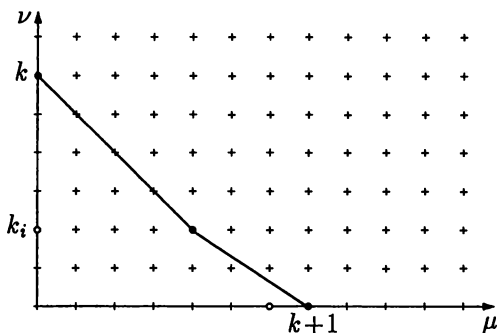

Figure A.5.1. Bound for the carrier of f

Now,

$$\text{mult}(C_i, P_q C) = \text{ord}_T \frac{\partial f}{\partial Y}(T^{k_i}, \varphi(T)).$$

The orders of the summands can be estimated by

$$\text{ord}_T a_j Y^{k-j-1} \geq \begin{cases} k k_i + k - j - 1 - k_i & \text{if } 0 \leq j \leq k - k_i, \\ k k_i + k - j - 1 & \text{otherwise.} \end{cases}$$

The minimum value of the lower bound is $k k_i - 1$ for $j = k - k_i$. This proves (**). □

For simple double points and simple cusps, $c = k(k-1) = 2$. The cases for which the inequality above is sharp can be given explicitly (see [Na], 2.1.5).

A.5.6. By definition, the invariant c depends not only on the singularities of the individual branches but also on the relative positions of the branches. To get a more detailed picture, we consider a few more examples.

Examples. a) As in Section 8.1, we consider the irreducible germ

$$C = V(Y^k - X^r),$$

with relatively prime k , r , and $1 \leq k < r$. Then $\text{ord } C = k$. The parametrization

$$T \mapsto (T^k, T^r)$$

gives

$$c = r(k - 1) - k + 1 = (r - 1)(k - 1).$$

Thus, by a suitable choice of k and r , we can spread the a priori inequalities

$$0 \leq k(k - 1) \leq c$$

arbitrarily far apart.

b) If $C = C_1 \cup C_2$ consists of two smooth branches, then $k = 2$. If the two tangents are distinct (ordinary double point), then $c = 2$ as well. For instance, if

$$C = V(f_1) \cup V(f_2) = V(Y - X^r) \cup V(Y + X^s), \quad \text{where } 2 \leq r \leq s,$$

then $V(Y)$ is the common tangent, and

$$c = 2r, \quad \text{so } 2 = k(k - 1) < c.$$

In this case, the invariant $\delta = \frac{1}{2}c$ is equal to the intersection multiplicity of the two branches.

c) The case of two branches as in Example (a) is left to the reader as an exercise.

In the following figures, $\kappa = \frac{1}{2}k(k - 1)$ and $\delta = \frac{1}{2}c$. A look at these figures makes it clear yet again how little of the intricacy of a singularity can be seen in the real plane. For the examples in (a), the parametrization can be restricted to $S_1 \subset \mathbb{C}$. The image of S_1 in $S_1 \times S_1 \subset \mathbb{C}^2$ is a so-called *torus knot*, which appears as the *boundary of a neighborhood* of the singularity (see [B-K]). Only two of its points can be seen in the real plane.

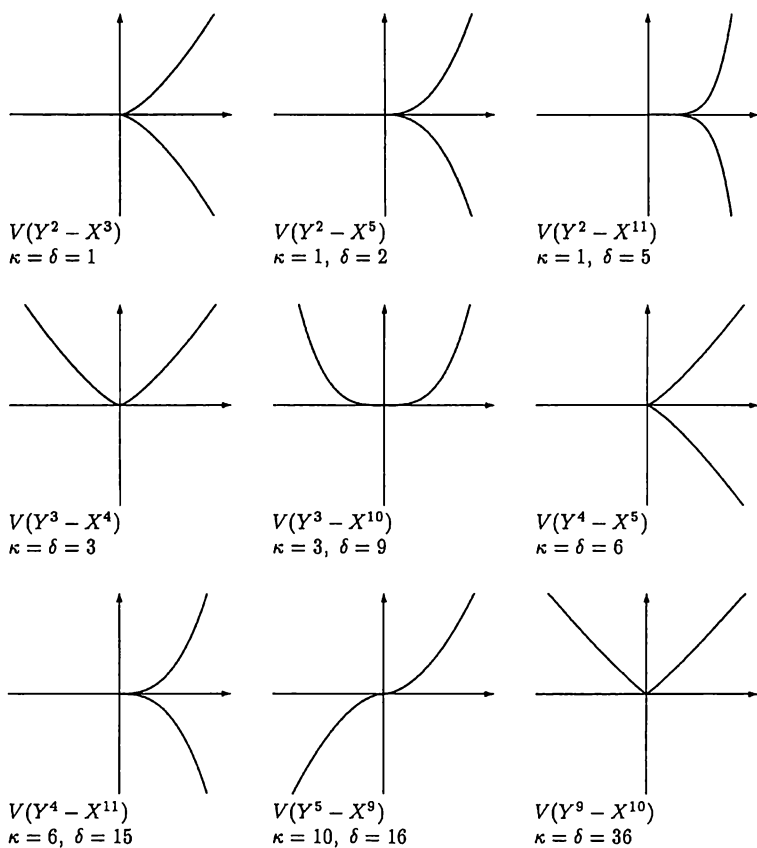

Figure A.5.2. Irreducible germs with relatively prime exponents (Example (a))

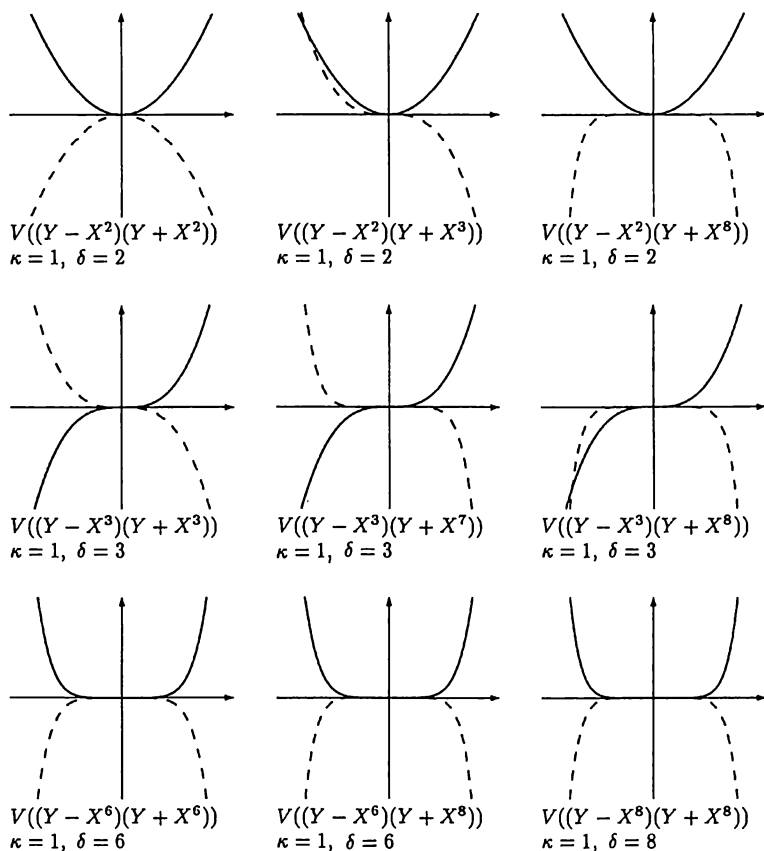

Figure A.5.3. Each picture shows two smooth branches with a common tangent $V(Y)$ (Example (b))

Harnack's Inequality

A.6.1. We saw at the beginning of Chapter 1 that a satisfactory theory of plane curves becomes possible only if complex zeros are also taken into consideration. It is especially pleasant when one can draw conclusions from them about the original real curve. Unfortunately such cases are rather rare. The last part of this book is intended to provide at least one nice example of this type.

Let

$$F \in \mathbb{R}[X_0, X_1, X_2], \quad \deg F = n,$$

be a homogeneous polynomial. Its zero set is a cone $V(F) \subset \mathbb{R}^3$, which corresponds to a real algebraic curve

$$C = \{(x_0 : x_1 : x_2) \in \mathbb{P}_2(\mathbb{R}) : F(x) = 0\}.$$

We assume it is *smooth*; that is, at every point of C , the homogeneous gradient of F does not vanish (see Section 3.6). Then C is a compact one-dimensional differentiable manifold, and by a well-known theorem from real analysis [Mi] every connected component $C' \subset C$ is homeomorphic to S_1 . We call C' an *oval* if its preimage in S_2 under the canonical covering map $S_2 \mapsto \mathbb{P}_2(\mathbb{R})$ splits into two components.

Exercise. If n is even, then all the components of C are ovals.

If n is odd, then exactly one component of C is not an oval.

The ovals in $\mathbb{P}_2(\mathbb{R})$ are null-homotopic; every non-oval component represents the generator of $\pi_1(\mathbb{P}_2(\mathbb{R})) = \mathbb{Z}/2\mathbb{Z}$.

A.6.2. What is the maximum possible number of connected components? This question is answered by the following result.

Harnack's inequality. *Let $C \subset \mathbb{P}_2(\mathbb{R})$ be a smooth algebraic curve of degree n , and let r be the number of connected components. Then*

$$r \leq \frac{1}{2}(n-1)(n-2) + 1.$$

This was first published by Harnack in 1876 [H]. A proof using methods of real algebraic geometry can be found in [B-C-R]. But it can also be derived from the genus formula of Section 9.7. We follow the presentation of [Sh] (see also [We]). It would go far beyond the scope of this book to introduce the necessary topological techniques here. We only note what is used.

Consider the complex projective curve

$$S = V(F) \subset \mathbb{P}_2(\mathbb{C})$$

corresponding to the given real polynomial F . To simplify the proof we suppose S is smooth, and thus a Riemann surface. (Singularities of S cause additional problems in constructing the triangulation and the intersection form.) Complex conjugation in \mathbb{C} yields a homeomorphism

$$\tau' : \mathbb{P}_2(\mathbb{C}) \rightarrow \mathbb{P}_2(\mathbb{C}), \quad (x_0 : x_1 : x_2) \mapsto (\bar{x}_0 : \bar{x}_1 : \bar{x}_2),$$

whose fixed-point set is $\mathbb{P}_2(\mathbb{R})$. Now, $\tau'(S) = S$ because F has real coefficients, so $C \subset \mathbb{P}_2(\mathbb{R})$ is the fixed-point set of

$$\tau := \tau'|_S : S \rightarrow S.$$

Let g be the genus of S . By Section 9.4, it suffices to prove the inequality

$$r \leq g + 1. \quad (*)$$

The following figure makes this relationship between r and g seem plausible:

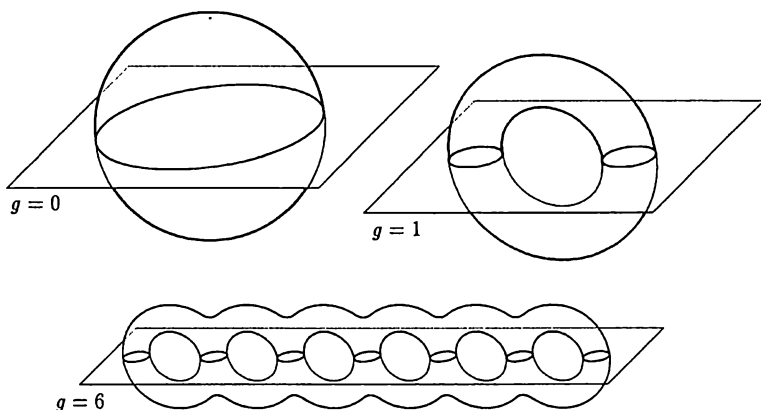

Figure A.6.1. Intersection of a “real” plane with a surface of genus g

For every triangulation of S we have the following vector spaces, over an arbitrary field \mathbb{F} and for $i = 0, 1, 2$:

$$\begin{aligned}
 B_i &\subset Z_i \subset K_i, \quad \text{where} \\
 K_i &\text{ denotes the } i\text{-chains,} \\
 Z_i &\text{ the } i\text{-cycles, and} \\
 B_i &\text{ the } i\text{-boundaries.}
 \end{aligned}$$

For $k = 1, 2$, let

$$\partial_i : K_i \rightarrow B_{i-1}$$

be the boundary operator. For $k = 0, 1, 2$,

$$H_i(S, \mathbb{F}) := Z_i / B_i$$

is the i th homology group of S with coefficients in \mathbb{F} . It is known from topology that this is independent of the choice of triangulation, and that

$$(1) \dim H_1(S, \mathbb{F}) = 2g, \quad \dim H_2(S, \mathbb{F}) = \dim Z_2 = 1.$$

Now, starting with a triangulation of the real curve C by 0- and 1-simplices and ensuring that the conjugates of 2-simplices in S are

2-simplices in S , we construct a τ -invariant triangulation of S with the following properties:

(2) For $i = 0, 1, 2$, the homeomorphism τ induces isomorphisms

$$\tau_i : K_i \rightarrow K_i$$

that are compatible with the boundary operators. We denote the τ -invariant chains by $K_i^\tau \subset K_i$.

(3) Let $z_1, \dots, z_r \in Z_1$ be the 1-cycles generated by the connected components of C , and let $V \subset Z_1$ be the subspace they span. Then

$$\partial K_2^\tau \cap V = \{0\}$$

if $\text{char } \mathbb{F} = 2$. This means that no cycle z_ρ can appear as the boundary of a τ -invariant 2-cycle.

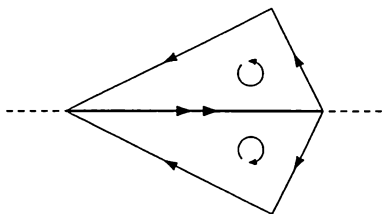

Figure A.6.2. τ -invariant cycle

Another tool we will need from topology is the *intersection form*

$$\sigma : H_1(S, \mathbb{F}) \times H_1(S, \mathbb{F}) \rightarrow \mathbb{F}.$$

This is an alternating bilinear form.

For two homology classes, σ counts (with weights in \mathbb{F}) the points of intersection of representative 1-cycles. If h_1, \dots, h_{2g} is a basis, then

$$\det(\sigma(h_i, h_j))_{i,j} \neq 0.$$

A subspace $W \subset H_1(S, \mathbb{F})$ is called *isotropic* if $\sigma(w, w') = 0$ for all $w, w' \in W$. It is known from linear algebra that this implies

$$\dim W \leq \frac{1}{2} \dim H_1(S, \mathbb{F}) = g.$$

Now let

$$\varrho : Z_1 \rightarrow H_1(S, \mathbb{F}) = Z_1/B_1$$

be the canonical homomorphism, and let $W = \varrho(V)$. Since the cycles z_1, \dots, z_r are pairwise disjoint and each can be replaced by a homologous one with no self-intersections, W is isotropic. Hence

$$(4) \dim \varrho(V) \leq g.$$

A.6.3. With all these techniques available, the proof of the inequality (*) is a pure pleasure. We use the little field $\mathbb{F} = \mathbb{Z}/2\mathbb{Z}$. It must be shown that

$$\dim_{\mathbb{F}} V \leq g + 1,$$

and because of the equation

$$\dim V = \dim \varrho(V) + \dim(V \cap \ker \varrho)$$

and (4), it suffices to prove that

$$\dim(V \cap \ker \varrho) \leq 1.$$

Over \mathbb{F} , this means that if two elements satisfy

$$0 \neq b, b' \in V \cap \ker \varrho = V \cap B_1,$$

then $b = b'$. Take $k, k' \in K_2$ such that

$$b = \partial k \quad \text{and} \quad b' = \partial k'.$$

Since $V \subset Z_1^T$, it follows that

$$\partial k = b = \tau b = \tau \partial k = \partial \tau k, \quad \text{so} \quad \partial(k + \tau k) = 0 \quad \text{and} \quad k + \tau k \in Z_2.$$

Hence $k + \tau k \neq 0$, because otherwise $k \in K_2^T$ and, by (3), $\partial k = b = 0$. Similarly, $k' + \tau k' \neq 0$. Since $\dim Z_2 = 1$, it follows that

$$k + \tau k = k' + \tau k', \quad \text{so} \quad \tau(k + k') = k + k' \quad \text{and} \quad k + k' \in K_2^T.$$

Again because of (3), it follows that

$$b + b' = \partial(k + k') \in V \cap \partial K_2^T, \quad \text{so} \quad b = b'. \quad \square$$

Examples of curves with the maximum number of connected components were already constructed by Harnack [H] (see also [B-C-R]).

Bibliography

- [A1] S. S. Abhyankar, *Local Analytic Geometry*, Academic Press, New York, 1964.
- [A2] S. S. Abhyankar, *Historical ramblings in algebraic geometry and related algebra*, Amer. Math. Monthly **83** (1976), no. 6, 409–448.
- [B-C-R] J. Bochnak, M. Coste, and M.-F. Roy, *Géométrie algébrique réelle*, Springer-Verlag, Berlin, 1987.
- [B-K] E. Brieskorn and H. Knörrer, *Plane Algebraic Curves*, Birkhäuser Verlag, Basel, 1986. Translated by J. Stillwell.
- [B-J] T. Bröcker and K. Jänich, *Introduction to Differential Topology*, Cambridge University Press, Cambridge, 1982. Translated by C. B. Thomas and M. J. Thomas.
- [Bu] W. Burau, *Algebraische Kurven in der Ebene*, Walter de Gruyter & Co., Berlin, 1962, Sammlung Göschen, Bd. 435.
- [Cha] K. Chandrasekharan, *Einführung in die analytische Zahlentheorie*, Springer-Verlag, Berlin, 1966, Lecture Notes in Mathematics, No. 29.
- [Che] A. Chenciner, *Courbes algébriques planes*, Université de Paris VII U.E.R. de Mathématiques, Paris, 1978.
- [D] J. Dieudonné, *Cours de géométrie algébrique*, Presses Univ. de France, 1974.
- [Fi] G. Fischer, *Analytische Geometrie*, Vieweg, Reinbek, 1978.
- [Fo1] O. Forster, *Lokale analytische Geometrie*, Math. Inst. der Univ. Münster, 1976.
- [Fo2] O. Forster, *Lectures on Riemann Surfaces*, Springer-Verlag, New York, 1981. Translated by B. Gilligan.

- [G-F] H. Grauert and K. Fritzsche, *Several Complex Variables*, Springer-Verlag, New York, 1976.
- [Go] D. Gorenstein, *An arithmetic theory of adjoint plane curves*, Trans. Amer. Math. Soc. **72** (1952), 414–436.
- [G-R1] H. Grauert and R. Remmert, *Analytische Stellenalgebren*, Springer, 1971.
- [G-R2] H. Grauert and R. Remmert, *Coherent Analytic Sheaves*, Springer-Verlag, Berlin, 1984.
- [H] A. Harnack, *Über die Vieltheiligkeit der ebenen algebraischen Kurven*, Math. Ann. **10** (1876), 189–198.
- [Ha] R. Hartshorne, *Algebraic Geometry*, Springer-Verlag, New York, 1977.
- [Ki] F. Kirwan, *Complex Algebraic Curves*, Cambridge University Press, Cambridge, 1992.
- [Kl] F. Klein, *Elementary Mathematics from an Advanced Standpoint: Geometry*, Dover, New York, 1939. Translated by E. R. Hedrick and C. A. Noble.
- [Ko1] K. Kodaira, *Complex Manifolds and Deformation of Complex Structures*, Springer-Verlag, New York, 1986. Translated by K. Akao.
- [Ko2] K. Kodaira, *On compact complex analytic surfaces. I*, Ann. of Math. (2) **71** (1960), 111–152.
- [Ku] E. Kunz, *Ebene algebraische Kurven*, Universität Regensburg Fakultät für Mathematik, Regensburg, 1991.
- [M] W. S. Massey, *Algebraic Topology: An Introduction*, Harcourt, Brace & World, Inc., New York, 1967.
- [Mi] J. W. Milnor, *Topology from the Differentiable Viewpoint*, The University Press of Virginia, Charlottesville, Va., 1965.
- [Na] M. Namba, *Geometry of Projective Algebraic Curves*, Marcel Dekker Inc., New York, 1984.
- [Ne] I. Newton, *The Mathematical Works of Isaac Newton*, vol. 2, Johnson Reprint Corp., New York, 1967.
- [P] D. Pecker, *Simple constructions of algebraic curves with nodes*, Compositio Math. **87** (1993), 1–4.
- [R] W. Rückert, *Zum Eliminationsproblem der Potenzreihenideale*, Math. Ann. **107** (1933), 259–281.
- [S] F. Severi, *Vorlesungen über algebraische Geometrie*, Teubner, 1921.
- [Sh] I. R. Shafarevich, *Basic Algebraic Geometry*, vol. 2, Springer-Verlag, New York, 1994. Translated by M. Reid.

- [St] L. Stickelberger, *Über einen Satz des Herrn Noether*, Math. Ann. **30** (1887), 401–409.
- [T] W. Thimm, *Vorlesung über Funktionentheorie mehrerer Veränderlicher*, Aschendorff, Münster, 1961.
- [Wa] R. J. Walker, *Algebraic Curves*, Princeton University Press, Princeton, 1950.
- [Wae] B. van der Waerden, *Einführung in die algebraische Geometrie*, Springer, 1939.
- [Wal] W. Walter, *A useful Banach algebra*, El. Math. **47** (1992), 27–32.
- [We] M. Westermann, *Ein Beweis der Ungleichung von Harnack mit Hilfe der Geschlechtsformel*, Diplomarbeit, Düsseldorf, 1994.
- [Z-S] O. Zariski and P. Samuel, *Commutative Algebra*, D. Van Nostrand Co., Inc., Princeton-Toronto-London-New York, 1960.

Subject Index

- Abel, Niels (1802–1829), 99
 Abel's lemma, 99
affine algebraic curve, 14
algebraically closed, 145
analytically equivalent, 205
atlas, 163
- Bézout, Étienne (1730–1783), 28
 Bézout's theorem, 31
Banach algebra, 101
bitangent, 10, 44
boundary of a neighborhood, 214
branch, 4
branch point, 140, 175
branching order, 175
Brieskorn, Egbert (b. 1936), xiv
Bureau, Werner (1906–1994), xiv
- canonical embedding, 24
cardioid, 77
carrier, 127, 197
Cauchy, Augustin Louis (1789–1857), 101
 Cauchy's estimate, 101
circle, 2
circle of curvature, 34
class, 88
 formula, 89, 210
Clebsch, Alfred (1833–1872), 90, 179
 Clebsch's genus formula, 179
complex
 atlas, 163
 manifold, 168
 structure, 168
component
- connected, of a topological space, 18, 190, 217
 irreducible
 of a curve, 17, 18
 of a germ, 122
cone, 25
connected, 175
continuity of the roots, 113
convergent
 formal power series, 100
 sequence of functions, 98
covering, 189
 map, 138, 189
 transformation, 142
Cremona, Luigi (1830–1903), 78
 Cremona transformation, 78
cubic, 89
cusp, 87
cuspidal cubic, 3, 60, 70, 76
cycloid, 7
- deck transformation, 142
decomposition into components, 27, 122
degree
 of a branched covering, 176
 of a covering map, 192
 of a curve, 19
 of a divisor, 19
 of a singularity, 209
Descartes, René (1596–1650), 6
 folium of, 6, 63, 70
Dieudonné, Jean (1906–1992), 23
discriminant, 136, 183
divisor, 19
 effective, 19
double point, 4

- dual
 - curve, 74
 - projective space, 73
- effective divisor, 19
- equivalent
 - local parametrizations, 156
 - principal analytic sets, 120
- Euler, Leonhard (1707–1783), 45
 - Euler's formula, 45
- Fermat, Pierre (1601–1665), 46
 - Fermat cubic, 69
 - Fermat curve, 46
- formal
 - convergence, 98
 - parametrization, 126, 135
 - power series, 97
- four-leaf clover, 38
- fundamental group, 190
- fundamental theorem of algebra, 28
- Gauss, Carl-Friedrich (1777–1855), 119
 - Gauss's theorem, 119
- general, 105
- genus, 50, 164, 169, 175
 - formula, 177
 - Clebsch's, 179
 - Max Noether's, 180
- germ
 - of a curve, 120
 - of a polar, 206
 - of a set, 120
- Gorenstein, Daniel (1923–1992), 209
 - Gorenstein-Rosenlicht theorem, 209
- Gorenstein-Rosenlicht theorem, 209
- Grauert, Hans (b. 1930), 96
- handle, 164
- Harnack, Axel (1851–1888), 218
 - Harnack's inequality, 218
- Hensel, Kurt (1861–1941), 116
 - Hensel's lemma, 116
- Hesse, Ludwig (1811–1874), 65, 69
 - Hessian curve, 65
 - Hessian matrix, 65
- Hilbert
 - Nullstellensatz, 15
- Hilbert, David (1862–1943), 11
- homogeneous
 - coordinates, 24
 - part, 20, 97
- homogenization, 25
- homology group, 219
- Hurwitz, Adolf (1839–1919), 176
 - Riemann-Hurwitz formula, 176
- hypocycloid, 7, 78, 79
- ideal, 19
- implicit function theorem, 114, 143, 193
- infinitely near points, 209
- inflection point, 44, 67, 84
 - formula, 89, 212
- initial polynomial, 41, 46
- intersection form, 220
- intersection multiplicity, 28, 31, 150
- invariant, 19, 27, 73, 161, 205, 209
- irreducibility, 27
- irreducible, 17, 122, 143
 - component, 18, 122
- isotropic, 220
- Klein, Felix (1849–1925), xiv, 9, 23
- Knörrer, Horst (b. 1953), xiv
- Kronecker's theorem, 9
- Kronecker, Leopold (1823–1891), 9
 - Kronecker's theorem, 9
- Krull topology, 98
- line, 1
- local
 - branches, 95, 123
 - homeomorphism, 189
 - invariant, 149, 161
 - lift, 82
 - numerical invariants, 84, 85
 - parametrization, 125, 155
- Möbius, Ferdinand (1790–1868), 24
 - Möbius strip, 24
- maximal ideal, 98
- minimal polynomial, 19, 27
- Monge, Gaspard (1746–1818), 23
- multiple zero, 184
- multiplicity, 21
- Neil, William (1637–1670), 3
 - Neil's parabola, 3
- Newton, Isaac (1643–1727), 4, 6, 126
 - Newton polygon, 131, 197
 - Newton's nodal cubic, 4
- nodal cubic, 4, 77, 95
- Noether, Emmy (1882–1935), 120
- noetherian, 120
- Noether, Max (1844–1921), 90, 180
 - Max Noether's genus formula, 180
- Nullstellensatz, 15
- order, 37, 97
 - of a germ, 123
 - of a power series with fractional exponents, 145
- order of contact, 42
- ordinary r -fold point, 41
- orientable, 164
- oval, 217
- ovoid, 38

- parametrization, 81, 141
- Peano, Giuseppe (1858–1939), 11
 - Peano curve, 11
- Picard, Émile (1856–1941), 138
- Plücker, Julius (1801–1861), 73
 - Plücker curve, 88, 179
 - Plücker formulas, 89
- point at infinity, 24
- polar, 60
- pole, 60
- polynomial part, 97
- principal analytic set, 120
- projective
 - algebraic curve, 26
 - closure, 26
 - plane, 23
 - tangent, 46
- proper, 191
- Puiseux, Victor (1820–1883), 126
 - Puiseux pair, 149, 152
 - Puiseux series, 126
 - Puiseux's theorem (geometric version), 136
- quadric, 60, 75, 89
- quartic, 7, 89
- quasihomogeneous
 - initial polynomial, 130
 - polynomial, 128
- rank, 23
- rational
 - curve, 169, 180
 - parametrization, 2, 8, 40, 163
- real algebraic curve, 217
- reducible, 17, 122
- Remmert, Reinhold (b. 1930), 96
- resolution of singularities, 81, 163, 169
- resultant, 181
- Riemann, Bernhard (1826–1866), 23, 176
 - Riemann surface, 81, 163
 - Riemann-Hurwitz formula, 176
 - Riemann-Roch theorem, 169
- Roch, Gustav (1839–1866)
 - Riemann-Roch theorem, 169
- Rosenlicht, Maxwell (1924–1999), 209
 - Gorenstein-Rosenlicht theorem, 209
- Rückert, Walter (1906–1984), xiv
- secant, 150
- shear, 105
- sheet number, 176, 192
- sheets, 189
- simple
 - cuspidal, 87
 - double point, 86
 - inflection point, 44
 - tangent, 44
- singular, 35
- singular locus, 36
- singularity, 4, 84
- smooth, 35, 46, 125
- snowflake curve, 11
- Stickelberger, Ludwig (1850–1936), 96
- Study, Christian (1862–1930), 15, 121
 - Study's lemma, 15, 121
- substitution homomorphism, 103, 115
- tangent, 36, 41, 47, 147, 150
 - cuspidal, 29
 - inflectional, 44
 - simple, 44
- Taylor expansion, 37
- Teichmüller, Oswald (1913–1943)
 - Teichmüller space, 168
- Teissier, Bernard (b. 1945), 197
- three-leaf clover, 38
- torus knot, 214
- triangulation, 219
- unique factorization domain, 117, 120
- unit, 99, 101
- valuation, 108
- variety, 13, 25
- Walker, Robert J. (1909–1992), xiv
- Weierstrass, Karl (1815–1897), 69, 90
 - Weierstrass division theorem, 108
 - Weierstrass polynomial, 106
 - Weierstrass preparation theorem, 107
- weights, 128
- Whitney, Hassler (1907–1989), 13

List of Symbols

$\ f\ _\theta$, 100	$H(C)$, 65
B_θ , 101	$\mathcal{J}(C)$, 19
$\gamma(n)$, 49	k_p , 180
C^* , 74	\mathfrak{m} , 98
$\mathbb{C}[X_1, X_2]$, 14	$\text{mult}_p(C_1 \cap C_2)$, 31
$\mathbb{C}[[X_1, \dots, X_n]]$, 97	$\text{mult}(C, C')$, 150
$\mathbb{C}\langle X_1, \dots, X_n \rangle$, 100	$\text{ord}_p(f)$, 38
$\mathbb{C}[[X^{\frac{1}{n}}]]$, 144	$\text{ord}_p(C)$, 38
$\mathbb{C}[[X^*]]$, 145	$\text{ord } f$, 97
c_p , 180	$\text{ord}(V(f))$, 123
$\text{carr}(f)$, 127, 197	$\text{ord } \varphi$, 145
D_f , 183	$\mathbb{P}_2(K)$, 23
$D_q F$, 60	$\mathbb{P}_2^*(\mathbb{C})$, 73
$\deg C$, 19	$P_q C$, 60, 206
$f^{(d)}$, 20, 97	$R_{f,g}$, 181
$f^{(k)}$, 97	$\text{Sing } C$, 36
$g(S)$, 176	$T_p C$, 36
$\text{grad}_p f$, 35	$V(f)$, 13, 14, 121
$\text{grad}_p F$, 45	$V(F)$, 25
H_F , 65	$V_D(f)$, 120
	$v(\chi)$, 176

Plane Algebraic Curves

Gerd Fischer

From a review from the German edition ...

... a beautiful invitation to algebraic geometry, encouraging for beginners, and a welcome source for teachers of algebraic geometry ...

—Zentralblatt für Mathematik

The study of the zeroes of polynomials, which for one variable is essentially algebraic, becomes a geometric theory for several variables. In this book, Fischer looks at the classic entry point to the subject: plane algebraic curves. Here one quickly sees the mix of algebra and geometry, as well as analysis and topology, that is typical of complex algebraic geometry. Concrete examples and figures are given throughout the text.

This is an excellent introduction to algebraic geometry, which assumes only standard undergraduate mathematical topics: complex analysis, rings and fields, and topology. Reading this book will help establish the geometric intuition that lies behind the more advanced ideas and techniques used in the study of higher-dimensional varieties.

ISBN 0-8218-2122-9



9 780821 821220

STML/15

AMS on the Web
www.ams.org